



HAL
open science

Design of human error tolerant interface using fuzzy logic

Marius Beka Be Nguema, Christophe Kolski, Noël Malvache, D. Waroux

► **To cite this version:**

Marius Beka Be Nguema, Christophe Kolski, Noël Malvache, D. Waroux. Design of human error tolerant interface using fuzzy logic. *Engineering Applications of Artificial Intelligence*, 2000, 13 (3), pp.279-292. 10.1016/S0952-1976(99)00061-5 . hal-03331119

HAL Id: hal-03331119

<https://uphf.hal.science/hal-03331119v1>

Submitted on 8 Jul 2022

HAL is a multi-disciplinary open access archive for the deposit and dissemination of scientific research documents, whether they are published or not. The documents may come from teaching and research institutions in France or abroad, or from public or private research centers.

L'archive ouverte pluridisciplinaire **HAL**, est destinée au dépôt et à la diffusion de documents scientifiques de niveau recherche, publiés ou non, émanant des établissements d'enseignement et de recherche français ou étrangers, des laboratoires publics ou privés.

Design of a human-error-tolerant interface using fuzzy logic

M. BEKA BE NGUEMA, C. KOLSKI, N. MALVACHE¹

Laboratoire d'Automatique et de Mécaniques Industrielles et Humaines (LAMIH - UMR CNRS 8530)

D. WAROUX

Gaz de France - Direction de la Recherche - B.P. 33 - 93211 La Plaine Saint Denis Cedex, FRANCE

Abstract. This paper describes the development of a human-machine interface which is tolerant of human error during the control of a simple industrial process. Human-error-tolerant interfaces (HETI) should be applied to industrial processes in order to keep the human operators sufficiently vigilant to enable them to handle unexpected events. With this goal, a global architecture for a HETI is proposed here; it integrates a human operator model (concerned with possible human actions and potential errors). For the design of this model, preliminary human behaviours and errors during the control of a simulated process have been analysed. This enables the authors to devise general rules, to be used when programming such an interface, using fuzzy logic. The HETI design and evaluation are described in the paper.

Keywords. Human-machine interfaces; human error; human behaviour; fault tolerance; human operator models; fuzzy logic.

1. Introduction

Today's increasingly complex industrial systems require highly skilled operators, who need to control several parameters at once. This implies that human reliability should be ensured (Swain and Guttman, 1983; Rasmussen, 1986; Hollnagel, 1994; Laprie et al., 1995; Kolski, 1997).

Certain circumstances may bring about grave errors, even with reliable operators (Reason, 1990). One way of avoiding such errors is to develop specialised, intelligent (or adaptive) help systems (Hancock and Chignell, 1989; Schneider-Hufschmidt et al., 1993; Kolski et al., 1993; Kolski and Le Strugeon, 1998). The Human-Error-Tolerant Interface (HETI) corresponds to a special kind of help system (Rouse and Morris, 1985; Coonan, 1986); one that is aimed at minimizing the consequences of certain human errors by keeping human operators alert in the face of an unexpected event. In order to be truly efficient, the HETI has to understand the human actions, and correct them in cases of error. It is why the preliminary analysis and modelling of the human errors is a very important step in the design of the so-called "human error tolerant interfaces". The model must be coherent with what the human operator has to do in summing the application.

This paper is composed of four parts. In the first part, the global principles of the HETI are defined. The second part explains preliminary experiments aimed at studying and modelling human errors that would be tolerated by the HETI to the greatest degree possible. Based on the data obtained from the preliminary experiments, a HETI is described in the third part; of course, this

¹ The correspondance should be adressed to Prof. Christophe KOLSKI, LAMIH - UMR CNRS 8530, Université de Valenciennes et du Hainaut-Cambrésis - Le Mont-Houy, B.P. 311, F-59304 Valenciennes Cedex, FRANCE, E-mail : christophe.kolski@univ-valenciennes.fr

HETI must be considered as a laboratory prototype, aimed at proving the feasibility of such an approach. This HETI was designed using fuzzy logic, which is the most suitable artificial intelligence method for operator-activity modelling (Rouse and Rouse, 1983; Cacciabue et al., 1990; Shaw, 1993). The main appeal of fuzzy-logic models is that they take into account the imprecisions and uncertainty of human judgement (Zadeh, 1965; Kaufmann, 1972; Pedrycz, 1989; Yager and Filev, 1994). The evaluation of the HETI, tested within a laboratory (controlled) environment, is explained in the last part of this paper.

2. Human-error-tolerant interface (HETI): global principles

The development of interfaces that are tolerant of human errors is, in practice, based on preliminary studies of the kinds of errors that humans make in simulated and/or real conditions. In these studies, errors are identified by recording actions that result in the behaviour of the human-machine system failing to meet well-defined criteria of productivity or safety. The idea is to use such studies to develop ways which, in the real world, will make it possible to replace, improve or negate inappropriate human actions (Rouse and Morris, 1985; Hollnagel, 1989, 1994; Beka Be Nguema et al., 1993; Masson and De Keyser, 1992; Masson, 1994).

It should be noted that, from the theoretical viewpoint, these studies are based on task analysis, and the modelling of human tasks related to how people reason, leading to human error taxonomies (Norman, 1983; Leplat, 1985; Rasmussen, 1986; Rasmussen and Vicente, 1989; Reason, 1990; Senders and Moray, 1991).

There is no unique or unified architecture for a HETI to be found in the research literature. A possible architecture of such an interface could consist of three major modules; see Fig. 1.

- There is a decoding module, which translates the human actions (i.e., the input commands of the human operator) into data that the HETI can use.
- A second module first identifies the human actions in all control situations. It is based on: (1) a *human actions model*, which describes what the human operator can do in all possible control situations, and (2) a model of the industrial application, which describes what should be done by the human operator in all possible control situations. This second module can then correct the actions in the event of human error. In the research literature, the *human actions model* and the *application model* can be combined into a so-called *human operator model*. This paper uses this terminology (*human operator model*).
- A third module is concerned with presentation of information on a graphical screen. It has two roles: it presents the state of the process variables, according to different presentation modes (bargraphs, trends, mimic displays, and so on, as in classical control rooms; see Rasmussen, 1986 or Kolski, 1997), and it explains to the human operator the problems that the HETI has diagnosed and the advantages to be gained from its proposed intervention (feedback from the module #2).

The research described below is particularly focused on the second module (programmed using fuzzy logic).

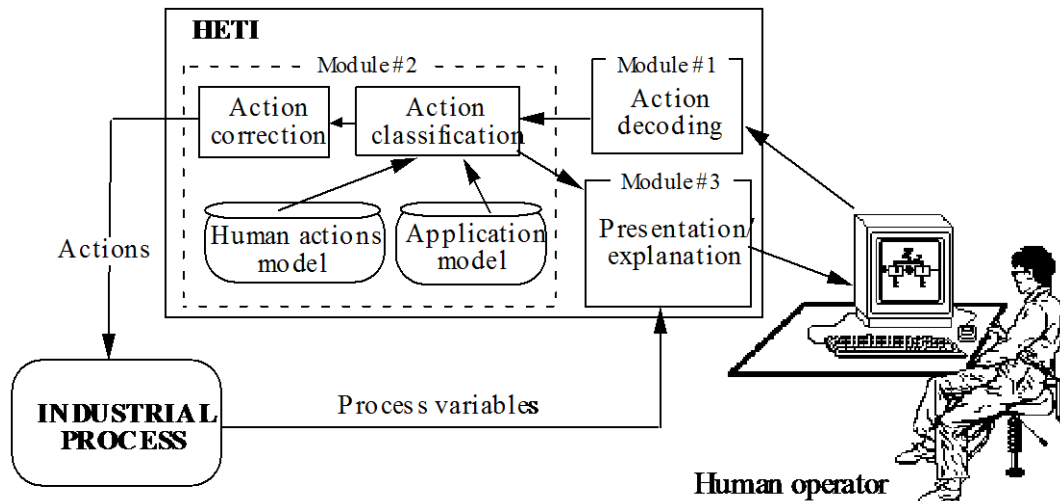

Fig. 1. Global architecture of a Human-Error-Tolerant Interface (HETI)

The usefulness of a HETI is undeniable, but it cannot always be applied. Such a system requires an extremely reliable model of the application, both of the possible situations and of the possible actions. The latter will not be exhaustive, because it will probably be based upon well defined fault conditions. But, in reality, totally new situations often arise. In the latter case, neither the HETI nor the human operator will have the necessary knowledge to cope with the problem on the basis of past experience, and this type of system will then not be effective. This is why a relatively simple process has been chosen to illustrate the features of the HETI (see the next section).

3. Preliminary experiments aimed at studying and modelling human errors

One of the aims of the HETI is to identify the human operator's action. In the event of human error in context of the application, that action must be corrected. Whatever the application, it is necessary to be aware of what errors the human operator is likely to commit. This is made possible by carrying out preliminary experiments, in a real context or by simulation, with operators, and by observing the errors that they commit during the performance of their process-control tasks. Without knowledge of the possible errors, it is impossible to design the HETI.

Such experiments are explained in this section. It begins by explaining the simulated industrial process, as well as the tasks that several dozens of subjects (acting as human operators) had to perform.

The human behaviours and errors identified during these experiments are then described. They are the results of two types of experiment: in the first, the human operators had one main task to perform (called a "single" task, in the research literature according to experimental tradition); in the second, the operators had a far more complex task, in that two tasks were to be performed in parallel (a "double" task context; see, for example, (Sperandio, 1972)), bringing about significant performance variations.

3.1. Human tasks considered

The goal of the preliminary experiments was to define the specification for the human operator model, to be integrated into the HETI. To achieve this, a study of human operator behaviour during the course of a simple simulated process was conducted, under various task configurations. Analysis of the experimental data allowed classification of the various kinds of behaviour, as well as the kinds of errors encountered in each task configuration. The task configurations used in the study are: presence of thermal inertia, presence of graphic deterioration, and double tasking (with two different tasks).

The experiments consider different types of human task, as follows.

- A manual task of temperature adjustment, in which the simulated industrial process is a quadruple heat exchanger. This process consists of a cooling system that takes hot water at a temperature (T_{1e}), and flow rate (Q_{1e}), and then cools it using cold water at a temperature (T_{2e}) and flow rate (Q_{2e}). The system is made up of four heat exchangers: e_1 , e_2 , e_3 and e_4 . These are connected in series on the hot-water circuit, and are fed cold water in parallel (see Fig. 2). Each exchanger is controlled by an up-flow dispenser, respectively named d_1 , d_2 , d_3 and d_4 , which sends cold water into the exchanger and redirects it into a secondary pipe when switched off. A similar dispenser, called d_0 , controls the hot water input in the cooling system. This redirects hot water into a secondary pipe when switched off, as would be the case in an emergency shutdown.

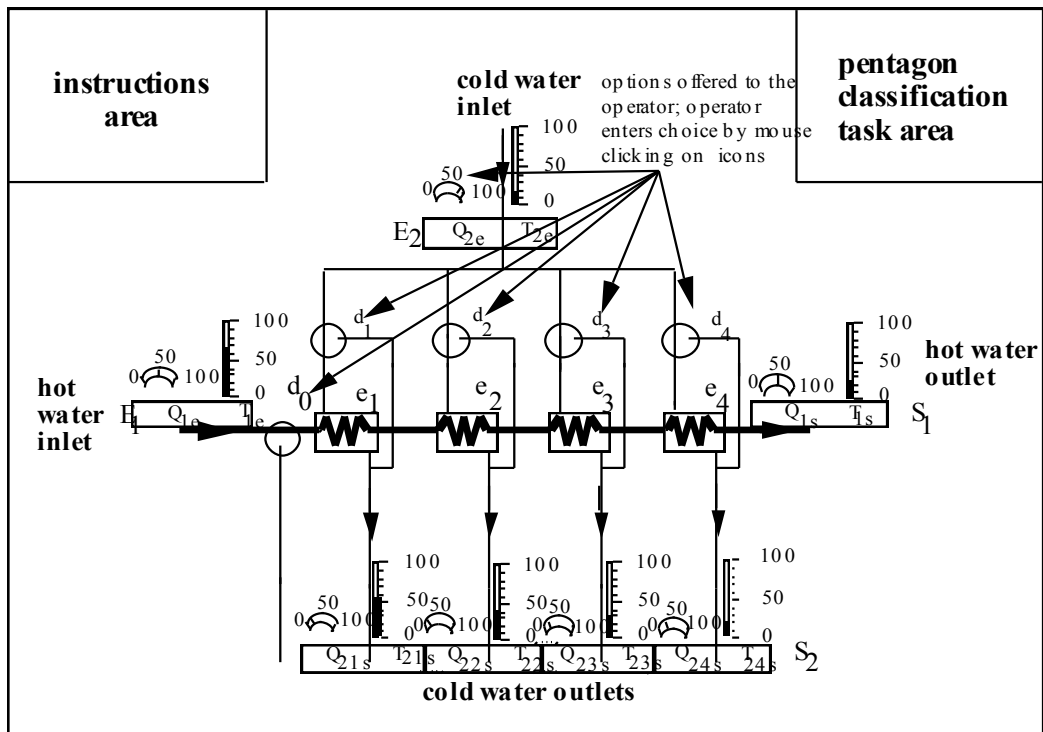

Fig. 2. Diagram illustrating the industrial process. This diagram appears on a graphic screen in front of the subject. The upper left-hand part is where instructions are given to the subject. Temperatures are represented by bar graphs; flow rates are represented by dials. The upper left-hand area is used for a pentagon classification task.

- A second task consists of classifying a series of pentagons (Fig. 3). In this classification task, 36 randomly selected pentagons, of any size, are displayed, one by one on the screen. From these, 11 belong to the "very large" category; 8 belong to the "large" category; 5 belong to the "medium" category; 4 belong to the "very small" category. Each display comes with a multiple-choice question and a space where the operator enters a self-evaluation of the certainty on a scale of 0 to 1, where 0 indicates null certainty and 1 indicates complete certainty about this classification.
- These two tasks can be combined under a so-called "double task", including both the temperature adjustment task and the classification task.

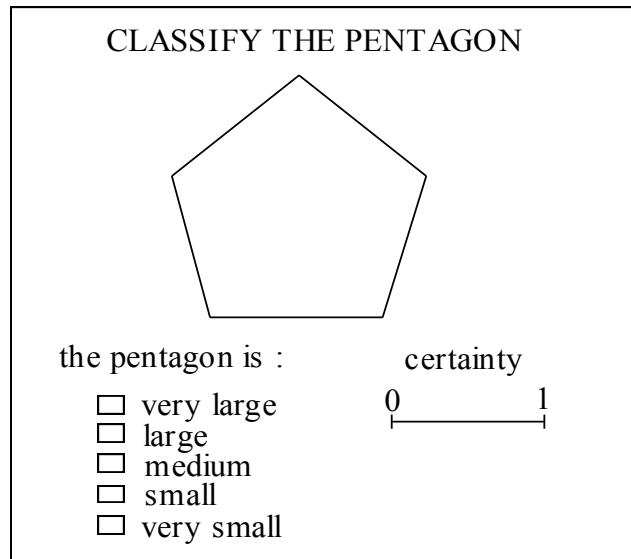

Fig. 3. Screen display for a pentagon-classification task.

In order to prove the feasibility of the HETI design, using the fuzzy-logic approach, two relatively simple tasks have been chosen. These tasks are not an accurate reflection of the many complex situations found in industry, and particularly in the control rooms of dynamic processes; thus, the results cannot be directly extrapolated to such complex processes. These tasks have been chosen because they allow the human behaviours and errors to be exhaustively identified during the preliminary experiments (this is very important in such exploratory researches) ; these tasks are also sufficient to overload the human operators, and thereby test their ultimate capabilities as regards error generation. For more complex processes in which the situations can prove to be too numerous to be studied in an exhaustive manner, it is a matter of studying whether it is possible to decompose the process into k simpler sub-systems. In that case, it then becomes possible to apply the same approach to one or several of these sub-systems, with the aim of designing a HETI. This is a research line in its own right which, to the authors' knowledge, has not been studied at international level.

3.2. First experiment conducted with 44 subjects (single task)

In the first experiment, conducted with 44 subjects (also called "human operators" in this section, even though the subjects are not real operators, but university students), the main human task consists of keeping the outlet temperature constant. First, each human operator (i.e., each subject) is instructed to aim for a temperature of between 20°C and 30°C in the outgoing hot water (T_{1s}). To achieve this, the operator may adjust the cold-water flow from Q_{2e} in increments of 10 m³/s. The operator also has control over the on/off switches of the main hot water dispenser ($d\theta$) and the individual heat exchangers. The operator is provided with continuous temperature and flow-rate readings from the hot water and cold water circuits, as shown in Fig. 4.

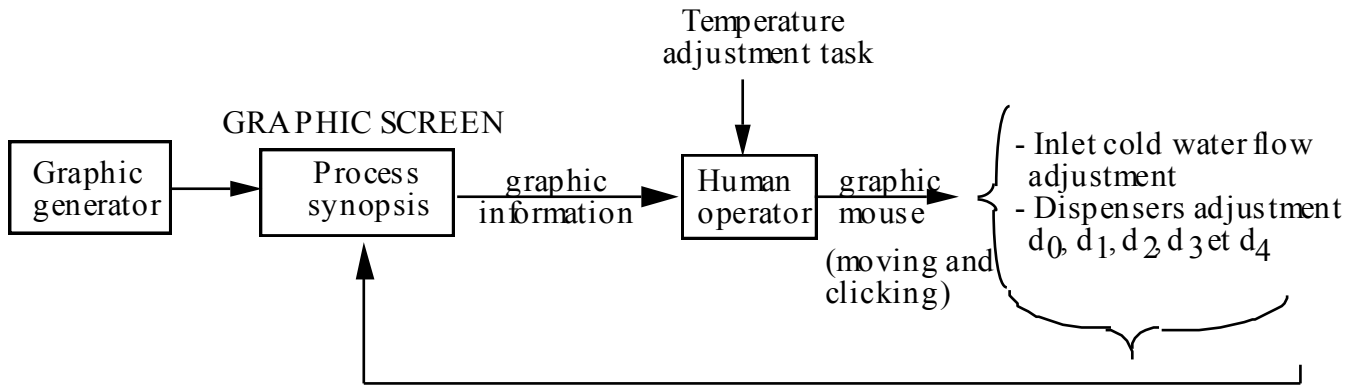

Fig. 4. Experimental system.

The test consists of twenty iterations, each lasting twenty seconds. The number of temperature adjustment sequences has been fixed at twenty to provide a more easily exploitable scaled results assessment. Operator-performance evaluation is accomplished by counting the number of acceptable temperature adjustments achieved by the operator over the course of the 20 sequences that the operator undergoes. An acceptable temperature adjustment is one where the desired final temperature (20°C-30°C) is achieved in less than 20 seconds, as shown in Fig. 5. Any sequence where the desired temperature range cannot be reached within 20 seconds, or where the d_0 dispenser is used to stop the temperature-adjustment sequence, is deemed unacceptable. The human operator is unaware of the 20s time limit. This limit was decided upon following test trials, done to validate the protocol, where 20 seconds was sufficient time for any operator to perform the task under normal operating conditions (to be defined later). However, the operator was asked, at the beginning of the test, to achieve the very best possible results.

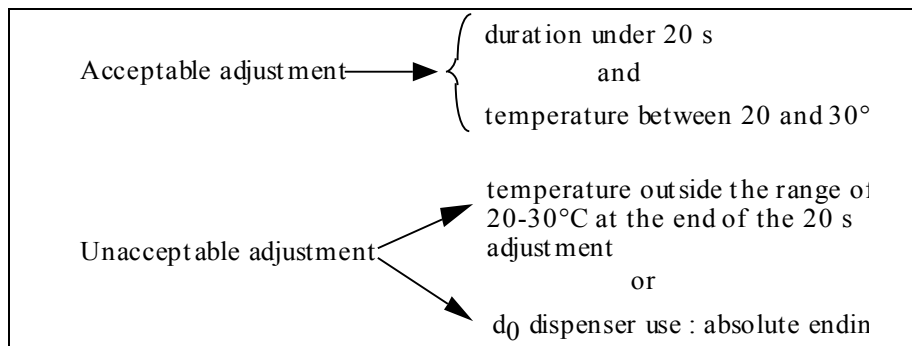

Fig. 5. Acceptable versus unacceptable temperature adjustments

This first experiment is divided into four stages.

- a) A training stage, which enables the human operator to get familiar with the process;
- b) A stage during which the temperature of the cold water inlet (T_{2e}) does not change; during this time the temperature and flow-rate of the hot water inlet vary between 10 and 100; these changes occur every 20 seconds. This stage corresponds to normal operating conditions.
- c) A stage where the above conditions deteriorate due to the addition of error-inducing, graphic-data alterations. The aim here was to bring the human operator to produce an error behaviour.

During both stages, the cold-water inlet temperature is 15°C. Hot-water inlet parameters are shown in Fig. 6. During the second stage, graphic data alterations P_1 , P_2 , P_3 and P_4 are introduced.

d) A stage similar to stage b), with the addition of thermal inertia in the outgoing hot water (T_{2e}). This inertia was selected so that temperature would seem to change slowly. The temperature variation delay may be adjusted according to the intended goal. The optimal value, obtained after preliminary testing, is $0.25 \text{ s/}^\circ\text{C}$.

3.3. Second experiment conducted with 28 subjects (double task)

For this second experiment, 28 of the 44 subjects were available. In the second experiment, each operator is to undertake the following tasks, illustrated in Fig. 6:

- One temperature-adjustment task, as described above,
- One pentagon-classification task (Fig. 3). This involves classifying 36 pentagons (appearing one by one on the graphic screen) according to pre-existing templates, then self-evaluating the certainty of this classification on a scale of 0 to 1. This gives an evaluation of the degree of confidence of the human operator in performing the task.

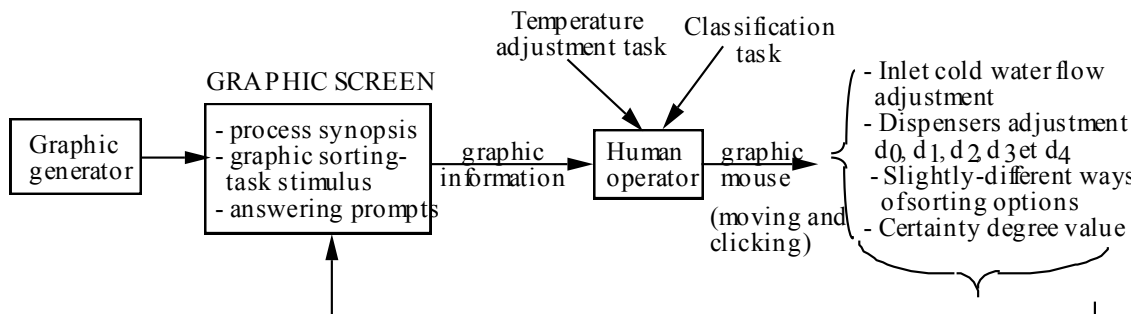

Fig. 6. Experimental system.

This pentagon-classification task is an often-used and well-documented study in the authors' laboratory (El Mechrafi and Malvache, 1991; Benhalima and Malvache, 1992; Desombre et al., 1995; Louas et al., 1998). It was selected for the present study to increase the complexity of the human task. Moreover, it uses very different assessment skills from those used in the first task. The human operator influences the process manually by clicking icons, and enters answers for the pentagon-classification task in the same way.

This second experiment is divided into three stages: (1) a training stage for the pentagon-classification task, (2) the pentagon-classification task, (3) double tasking, induced by the addition of the pentagon-classification task to the temperature-adjustment task. In every classification task, 36 pentagons are displayed, one by one, on the screen. This number was selected so that the two different tasks would take the same time.

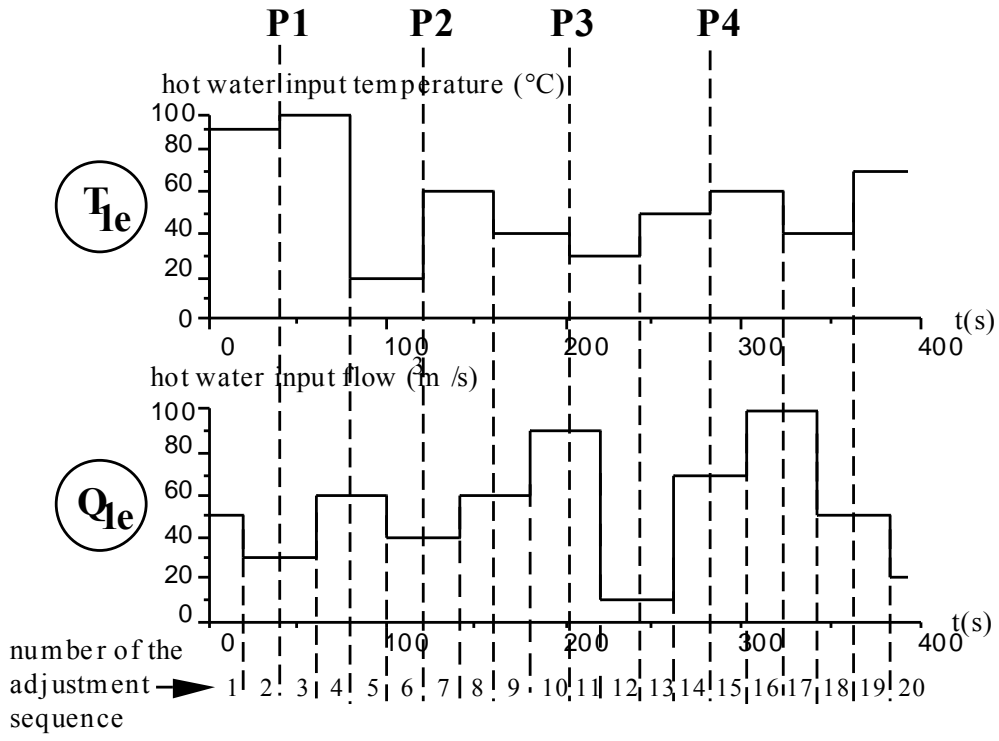

Fig. 7. Test sequences, showing changes in temperature and flow rate on the incoming hot water line. P₁, P₂, P₃ and P₄ mark the points at which the graphical display undergoes progressive deterioration (during the second of the two test phases only).

- P₁: all thermometer outlines disappear, and outgoing hot water thermometer starts to behave erratically,
- P₂: outgoing hot water thermometer disappears altogether,
- P₃: outgoing cold water thermometers start to behave erratically,
- P₄: outgoing cold water thermometers disappear altogether.

During the course of the pentagon-classification tasks, the pentagon display rate regularly increases so as to further complicate the task, as shown in Fig. 8.

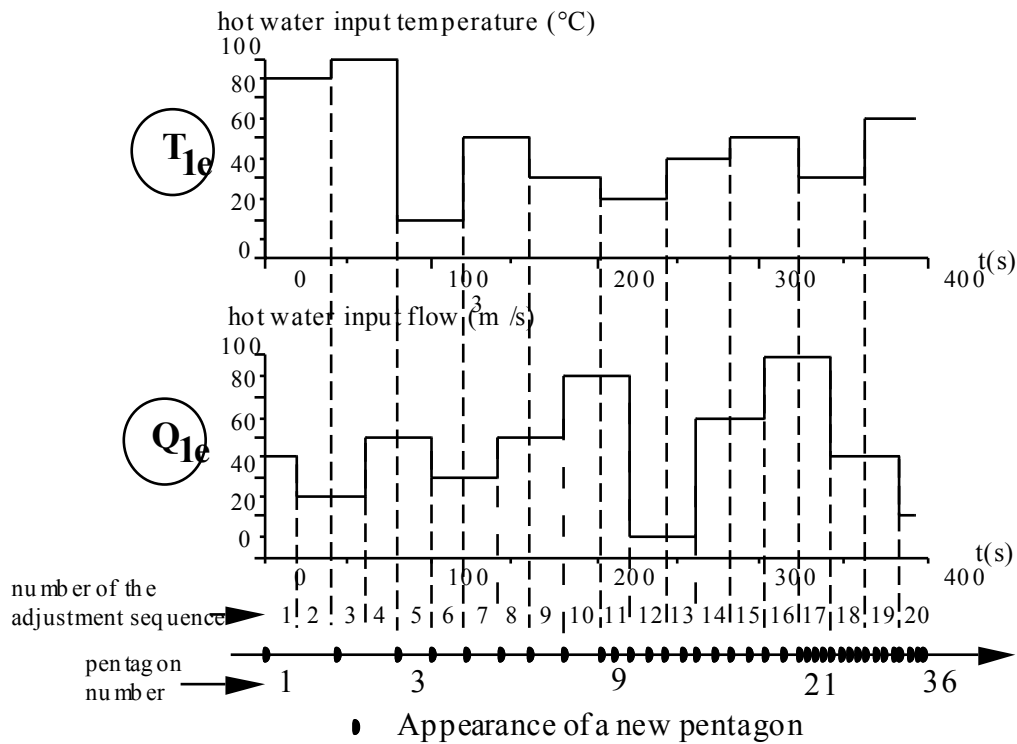

Fig. 8. Progress of the experiment. Pentagon appearances are synchronised with the beginning of the sequences; one new pentagon for every two sequences at first, then one pentagon per sequence, then two, then four.

For the HETI design, only the unaltered temperature adjustment task with thermal inertia, and the double task were used. The reasons for this selection are that the presence of a thermal inertia is closer to real-life conditions, and that double-tasking allows mental overload simulation, at least for the latter part of the experiment.

3.4. Results

Each experiment starts after the subject has completed an anthropometric identification questionnaire. This lasts from 40 to 60 minutes, according to the time needed by each operator to become familiar with the process. During the temperature-adjustment stage, the data collected are the variations in temperature, flow-rate and dispenser status parameters over time. At the end of the experiment, subjects are required to fill out another questionnaire; this time concerning the operator's perceptions about the experiment, data deterioration, and whether any available means were left either unused or little used by the operator during the experiment.

The results were processed using classical descriptive statistical methods (Bouroche and Saporta, 1980; Grais, 1992). Cumulative curves, histograms and hierarchical classification were used in the process. These results are fully described in (Beka Be Nguema, 1994). Forty subjects underwent the temperature-adjustment task experiment without data deterioration but with thermal inertia added; of these, 28 also underwent the double-task experiment. Some facts could be noted following the experiments.

- Subject reaction times and the duration of the adjustment were both longer in the case of an unacceptable adjustment than in the case of an acceptable adjustment.

- Subjects either used every adjustment parameter available, or used only the cold-water flow-rate, in the temperature-adjustment task.
- Some errors were due to the operator's inability to estimate the limits of the acceptable temperature range, thus causing slight 'oversteering'.
- An analysis of the subjects' answers in the after-experiment questionnaire showed that the subjects took into account only the outlet parameter and the adjustment variables when conducting the task.

Subjects were classified according to their performance, which was defined as the number of acceptable adjustments achieved over the total adjustment sequences. Only one subject had a performance of less than 10/20 when doing every temperature-adjustment sequence. Most subjects had a performance over 12/20. Two subjects' strategies gave good results. The first one, used by all but one of the subjects, was to use every available parameter: only the cold-water inlet at first, then the dispensers as needed. Another strategy, used by the remaining subject (who was the exception), was to use only the cold-water inlet, even if two sequences were then impossible to achieve.

Three kinds of behaviours were encountered among the subjects: (1) the "high-risk" takers: these continued the task even when insufficient information was available, or when they did not use "upstream" information; (2) the "measured-risk" takers: these continued the task until a certain critical point (varying from one subject to another) was reached, and then preferred to stop the process; (3) the "no-risk" takers: these stopped the process by activating the emergency d_0 dispenser as soon as something was amiss, especially during the data-deterioration stage.

Four main kinds of errors were observed. These are, from the most frequent to the least frequent, as follows.

- Errors caused by lack of attention (Reason, 1990): when the operator used the emergency shutdown during the temperature-adjustment task without thermal inertia and without data deterioration.
- Intended "errors": these are due to the operator's lack of motivation which can be seen during non-critical sequences of the first stage. The subjects concerned do not admit to these errors, which are therefore difficult to analyse.
- Errors caused by lack of understanding (Reason, 1990), which are typical of the beginning of the temperature-adjustment task without thermal inertia and without data deterioration. Behaviour is hesitant. These could also be delayed lack-of-attention errors.
- Errors due to poor estimation of the results (Leplat, 1985): these occur when the operators poorly estimate the outlet hot water temperature or the size of the pentagon.

These errors have been considered in the HETI design, which is the subject of the following section.

4. HETI Design based on the data obtained from the preliminary experiments

4.1. Functioning modes of the complete system, including the HETI

The system can work using any of the following modes, seen in Fig. 9:

- (1) In the "strictly automatic" mode, an automatic process-control system is implemented by the HETI when requested by the human operator. Actually, the process-control system is the fuzzy controller introduced earlier. The human operator has no further direct control over the process when using this mode. The strictly automatic mode could be useful to an inexperienced operator, by indicating the appropriate method of handling the process.
- (2) The "strictly manual" mode can only be activated on a request from the human operator. It gives the human operator total control over the process. When this mode is activated, the HETI is prevented from interfering with the process.
- (3) The "temporarily manual" or "normal" mode is the default functioning mode of the system. In this mode the system is controlled by the human operator, but the HETI is active.
- (4) The "temporarily automatic" mode can only be activated by the HETI, following a human error. The HETI leaves this mode as soon as the process reaches a non-critical state. It uses the same fuzzy controller as the "strictly automatic" mode.
- (5) The "transitory" modes are temporarily activated during the transition from the automatic to the manual mode, or vice versa (Fig. 9). Specific parameters for these modes will be explained in detail later.

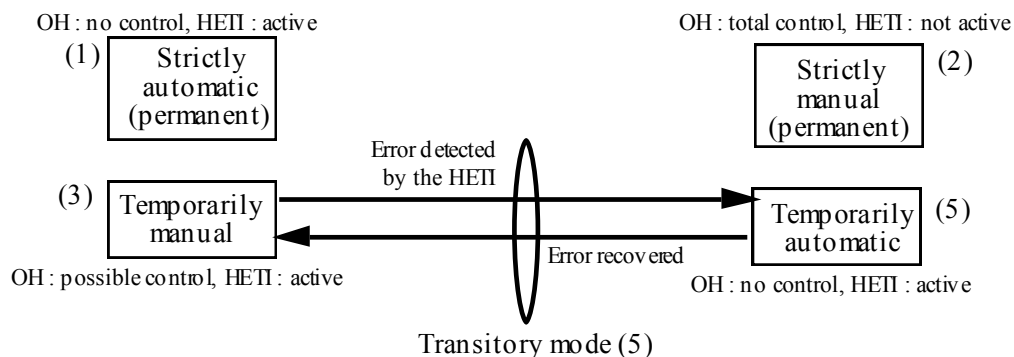

Fig. 9. HETI functioning modes.

In addition to the above modes, a help (advisory) function was defined. The purposes of this function are (1) to warn the human operator that an error has probably been made and (2) to give advice on the correct course of action. These actions are the same as those that would be taken by the human-operator model if the HETI were active.

The "strict" modes are permanent modes, where the HETI has a passive role towards the operator, and cannot initiate any change of modes. The "normal" and "temporarily" modes allow the HETI to take an active role in the process.

A three-button menu, related to the functioning modes, was defined. This is accessible via the graphic screen by the human operator. The three buttons are called respectively: AUTO, MANU and HELP, as illustrated in Fig. 10. The AUTO and MANU buttons are mutually exclusive, i.e. selection of the AUTO button deactivates the MANU button, and vice versa. The HELP button works independently of the other buttons.

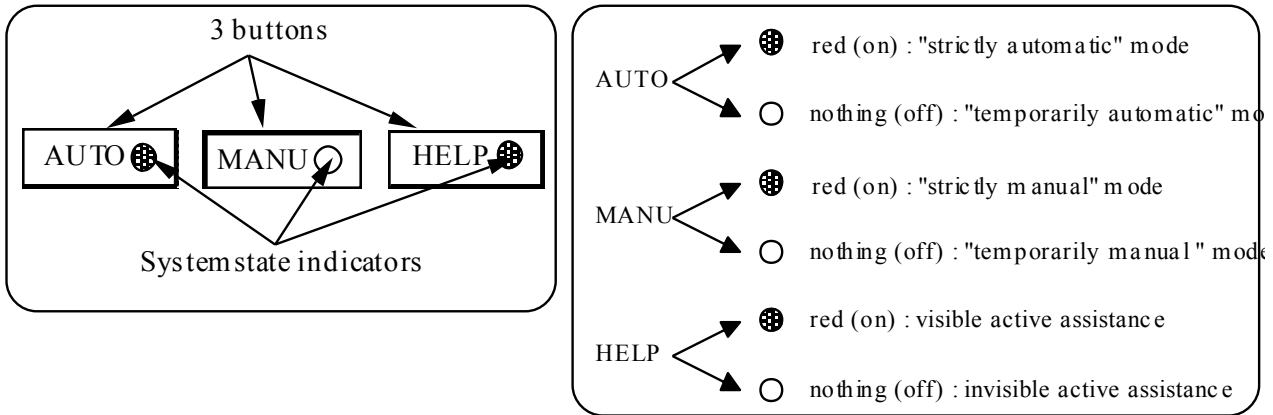

Fig. 10. Mode selection (directly on the graphic screen in a specific zone)

4.2. Structure of the HETI

The structure of the HETI is shown in Fig. 11. Throughout each task, the human operator has a number of options about the functioning modes of the system. Information about the state of the process is received, and the operator gets help, as needed, when the "help" mode is activated.

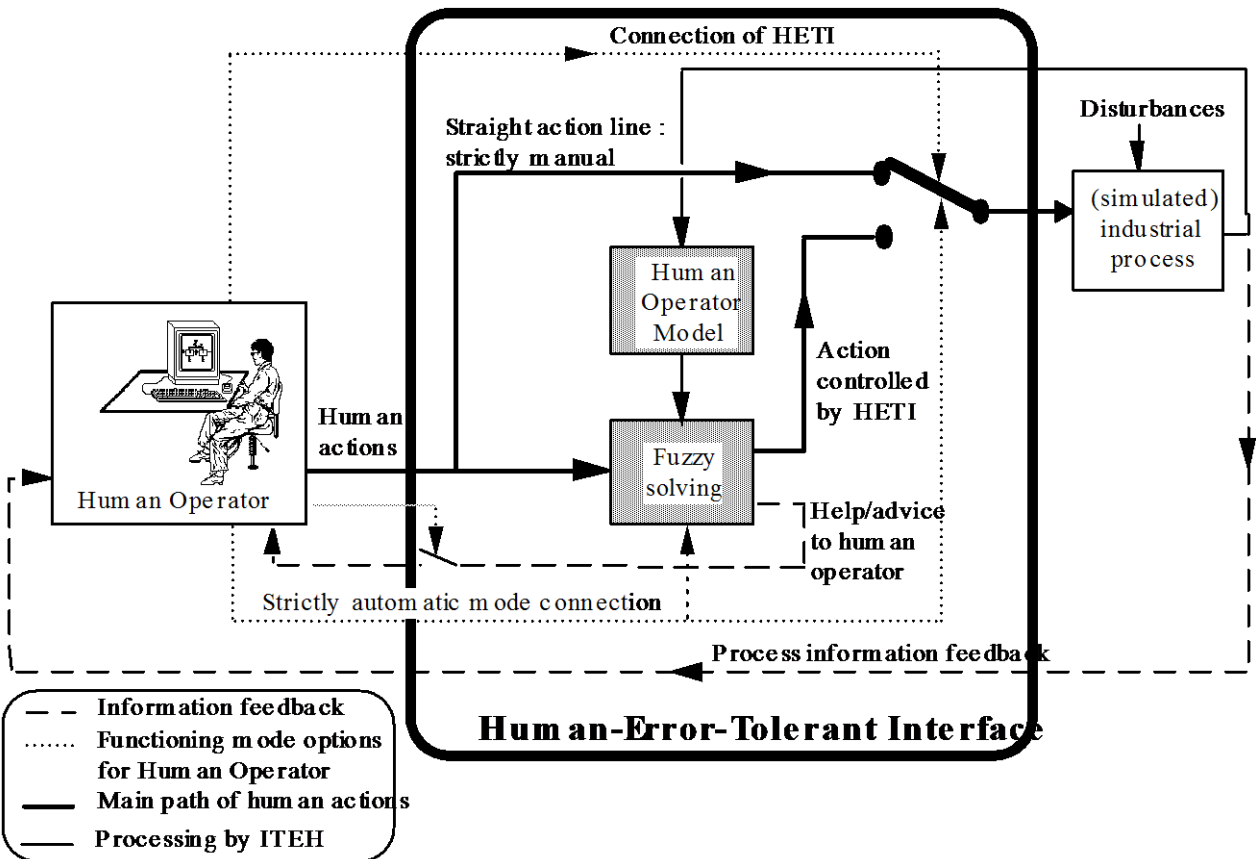

Fig. 11. HETI internal structure. The grey lines show the functioning mode options that the human operator may take. The dotted lines indicate the information output that can be used by the human operator. The bold lines show the input and the main outputs of the HETI. Finally, the fine lines show the processes mode within the HETI.

In this structure, a human operator model (concerned with possible human actions) is used. This model (along with fuzzy logic and fuzzy problem solving) comprises the fuzzy controller defined in subsection 4.3. In the event of human error, the fuzzy controller is designed to match the best operator strategy, which is correct: an efficient action is then applied to the process.

As seen in Fig. 11, the HETI is connected to a simulated process. The functioning modes of the complete system are described in subsection 4.1.

4.3. Description of the human operator model

The temperature-adjusting operator performs the role of a temperature-control device which is responsible for keeping the hot water outlet temperature within a given range. Similarly, the fuzzy model of this human operator is the equivalent of a fuzzy controller. Fuzzy logic was selected for this model because it takes into account human imprecisions and uncertainty. Moreover, it allows for descriptive modelling of knowledge and behaviour. The model's role in the HETI is threefold.

- To provide training to inexperienced human operators. During training, the right actions are shown to the human operator by the model.
- To provide assistance to human operators in overload situations. In this case the model calculates the preferred course of action, which is then indicated to the human operator.
- To assume control of the process when the operator is overwhelmed.

The fuzzy-logic reasoning controller selected here is similar to that designed by Sugeno and Nishida (1985). It allows direct output of the defuzzified control. Weights (W_i) are attributed to each rule (i). These weights are obtained from the premise of each rule. Every rule is systematically applied and used for control calculations. Fuzzification was performed using the simpler trapezoid function, to begin with. The rules and the fuzzy sets were determined according to five linguistic values:

VN -> very negative
N -> negative
Z -> zero
P -> positive
VP -> very positive

The fuzzy rules were set using the best operator's strategy. This operator's actions were used as a model for high-performance process control. In an ideal HETI, other (non-optimal) operator models must also be taken into account. In this case this operator's actions were observed during the temperature-adjustment task with thermal inertia, but without data deterioration. Indeed, preliminary testing has shown that the shortest possible procedures would give the best error-correction results from the HETI. A study of the operator's strategy highlighted two primary, logical principles. Whenever the hot water outlet temperature became higher than 30°C or lower than 20°C, the operator acted upon the number of in-use dispensers. However, if the temperature stayed within the desired range, the operator acted upon the cold-water inlet flow rate, which allows easier temperature control. This operator's strategy led to the design of five fuzzy rules, to be described in detail later.

The controller is composed of two fuzzy motors and one "strategy-choice device" (OCS), as shown in Fig. 12, so as to use both temperature-adjustment strategies: (1) acting upon the dispensers, and (2) acting upon the cold-water inlet flow rate. The strategy-choice device compares the outgoing water temperature with a set value of 25°C, which corresponds to a mid-range temperature. This 25°C value was used for stabilising and optimising the temperature control.

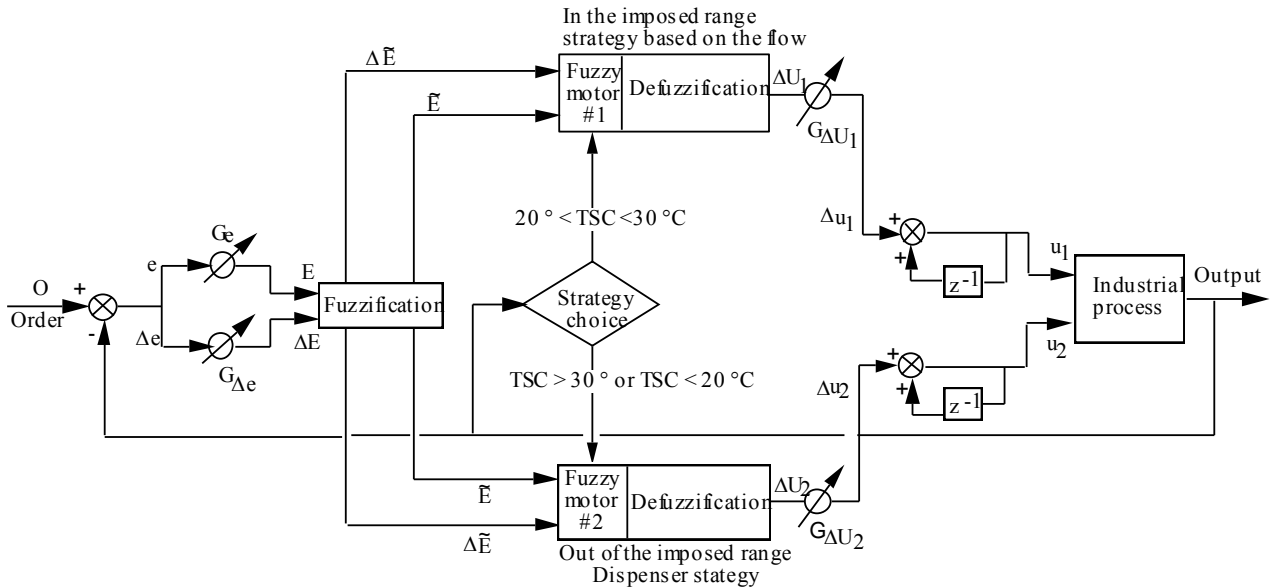

Fig. 12. Diagram of the principle used for the fuzzy regulation with strategy choice.

Each fuzzy motor receives the $\Delta \tilde{E}$ fuzzy variables (variation of the error between the outgoing hot water temperature and the mid-range value of 25°C, over time) and \tilde{E} (error between the mid-range value of 25°C and the outgoing hot water temperature of the process). However, only one of the motors selected by the OCS, does the controlling calculations. Motor #1 generates a flow-variation command, whereas Motor #2 generates a command to either add or remove a heat-exchanger.

4.3.1 The fuzzification. The fuzzification of error and error variation was found using the best operator's strategy. This was done according to the five linguistic values introduced earlier (VN, N, Z, P and VP), as shown in Figs 13 and 14. The Z linguistic value corresponds to a membership function where a 0°C gap between 25°C and the outgoing water temperature gives an ordinate of 1, figure 13.

Fuzzification of error and error variation was found using the best operator's strategy. This was done according to the five linguistic values introduced earlier (VN, N, Z, P and VP), as shown in figures 13 and 14. The Z linguistic value corresponds to a membership function where a 0°C gap between 25°C and the outgoing water temperature gives an ordinate of 1, see Fig. 13.

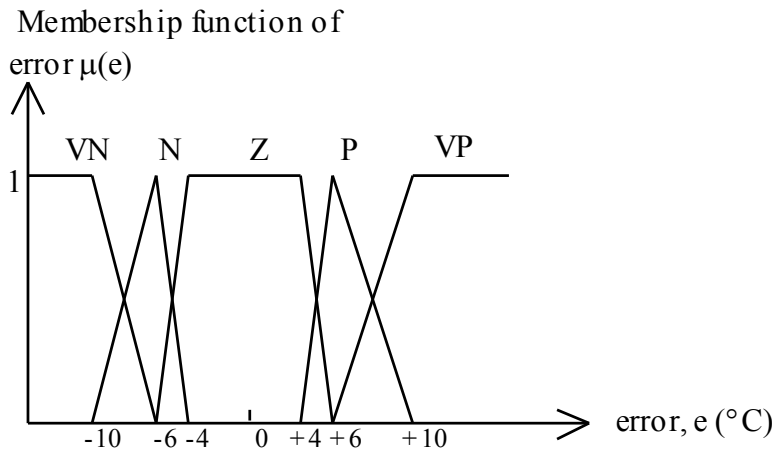

Fig. 13. Membership function for error. The "no error" category (Z) was widened in order to avoid wobbling within the imposed range.

In the case of a 2.5 °C/s thermal inertia, for instance, error variation (De) can really take only three values: -2.5°C/s, 0°C/s or +2.5°C/s, as shown in Fig. 14. These three values correspond to the possible rates of temperature variation within the hot-water outlet.

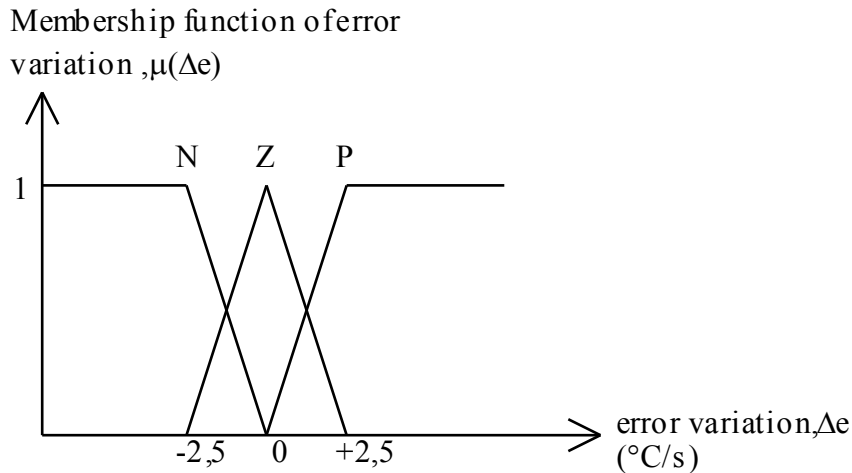

Fig. 14. Membership function of error variation De, m(De).

4.3.2 The fuzzy rules. The five fuzzy rules can be placed in a matrix form, as shown in Fig. 15. They constitute the matrix of controlling rules.

$\Delta e \backslash e$	VP	P	Z	N	VN
P	VN	Z	P	P	Z
Z	VN	N	Z	P	VP
N	N	N	N	-	VP

Fig. 15. Regulation rules matrix after adaptation. For example, the rule yielding a very positive Du command is the following: (if e is VN AND De is Z) OR (if e is VN AND De is N) THEN (Du is VP).

A W_i weight, which is independent of the AND and OR fuzzy operators, is given to each "number i" rule (from 1 to 5). Weight calculation allows an estimation of the ratios in which the commands of each rule must be applied. The relative importance of each weight is related to the state of the parameters within the process to be regulated. W_i weight values are given by Guerra (1991):

$$W_i = \text{OR}_{\ell}(\text{AND}[\mu_{E_j}(e_0), \mu_{\Delta E_k}(\Delta e_0)]) \quad (1)$$

where ℓ is an index that takes into account the number of entry combinations yielding the same Du command (a Δu command is a command that is acceptable to the operative part, from the fuzzy command); k are indices for the linguistic variables that are taken into account, and $m_X(x_0)$ is the membership function of the fuzzy value to the X fuzzy set.

The Min/Max logical functions are associated to the AND/OR functions:

$$\text{AND}(\tilde{A}, \tilde{B}) = \text{Min}(\tilde{A}, \tilde{B})$$

$$\text{OR}(\tilde{A}, \tilde{B}) = \text{Max}(\tilde{A}, \tilde{B}).$$

The weighting formula (1) comes down to a "maximum of minima" calculation, and becomes:

$$W_i = \text{Max} \left(\text{Min} \mu_{E_j}(e_0), \mu_{\Delta E_k}(\Delta e_0) \right) \quad (2)$$

4.3.3 The defuzzification. The controller output is obtained after calculating the weights of each rule. This can be done in many ways. If command variables Δu_i are set at the maximum of their linguistic values, two defuzzifications are possible (Buckley and Ying, 1991): linear and non-linear defuzzifications. Non-linear defuzzification was used here:

$$\Delta u = \frac{\sum_{i=1}^n W_i \cdot \Delta u_i}{\sum_{i=1}^n W_i} \quad (3)$$

where n is the number of rules (five in this case) and Δu_i are the maximum values of Δu for the flow rate and dispenser commands, see Figs 16 and 17.

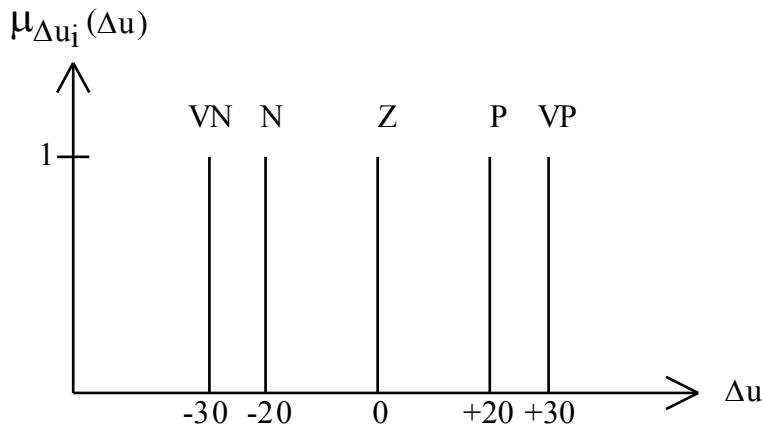

Fig. 16. Membership function of Du for fuzzy motor #1. This fuzzy motor is used to control the inlet cold water flow. Control variables Du_i are set at their maximum linguistic values. The arbitrarily set breakpoints are +20 and +30 for a flow-rate increase, and -20 and -30 for a flow-rate decrease.

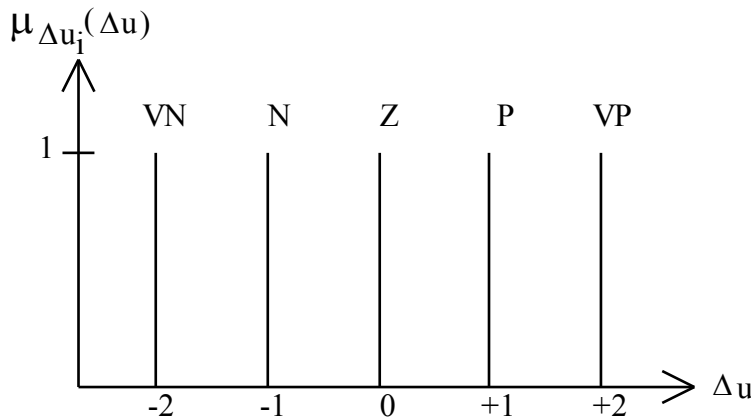

Fig. 17. Membership function of Du for fuzzy motor #2. This motor is used to control dispensers d_1 , d_2 , d_3 and d_4 . The arbitrarily set breakpoints are +1 and +2 for an increase in the number of available dispensers, and -1 and -2 for a drop in that number.

4.3.4 Performances obtained by the model. Several preliminary trials (without a human operator interacting with the HETI) have been performed in ways that validate the model technically. For the 20 temperature-adjustment sequences of the experimental protocol with thermal inertia, the model achieved the following performances:

- For a 20/20 regulation performance, 20 acceptable adjustments were made over the 20 adjustments that had to be done.
- During a change of input variables in the simulated process, the controller reacts with a less-than-one second delay.
- On average, a controller needs 3 seconds to find the next adjustment during each sequence change. This corresponds to the controlling program's execution time. The very best human operator's execution time was 6 seconds on average, whereas the overall mean (including all subjects) was 12 seconds. The gap between the best operator's time and the controller execution time is due to the human operator's delayed reaction (of 4 seconds on average).
- The controller is stable throughout the 20 sequences.
- A compromise was found so as to let the strategy choice device (seen in the centre of Fig. 12) use the best operator's temperature-adjustment strategy while keeping the system stable.

This technical performance is promising, and allowed the possibility of evaluating the HETI approach with real human operators. Such an evaluation is the subject of the next section.

5. Evaluation in laboratory with five experts

An evaluation was done by five experts in human-machine systems (between 8 and 15 years of experience each). The experts were all familiar with the research work being performed and the means being implemented. They were aware that, in principle, their performances were likely to improve with appropriate use of the HETI, and that this was one of the aims of the research project.

The aim of the evaluation was threefold here.

- The first aim was to check that, in situations when the HETI was in fact used, the expert's performance improved. (It should be noted that this aim was not truly crucial, given that many tests had been carried out previously in the laboratory with subjects who had already taken part in the preliminary experiments. These tests had already shown significant performance improvements when the HETI was used. A mere confirmation of this improvement was therefore expected.)
- The second was to study the behaviour of the experts in relation to the HETI. They could possibly (unlike the subjects of the preliminary experiments) try to catch the HETI out, or competing with it, or choose not to trust it, etc., whilst at the same time, obviously, they were attempting to obtain the best performance possible.
- The third aim was to collect remarks and criticisms before and after the experiment, according to technical and ergonomic criteria. (This evaluation principle is often used in real and/or simulated cases. It is fully explained and discussed in different versions by various authors: Ombredane and Faverge (1955), Molich and Nielsen (1990), Nielsen (1993), Wilson and Corlett (1996), and so on.)

5.1. The tasks performed by the five experts

The HETI structure that was evaluated is the same as that described above (Fig. 11), except that during the evaluation the expert selects the HETI option on the menu (Fig. 10) only if that expert considers it necessary. The HETI was automatically activated when no temperature adjustment could be achieved within 13 seconds. This HETI structure allows the avoidance of any errors that would cause an unacceptable temperature adjustment. The evaluation was performed using the double task, including the no-deterioration temperature-adjustment task with thermal inertia, and the pentagon-classification task. The task was done first without, and then with, the HETI. As in the above experiments, the experiment started with a training stage and simple tasks. In the double-task stages, the experts were required to complete the pentagon classification as a priority. The results are detailed in Table 1.

Table 1. Experts' results. The result of each classification is expressed as a "good classification" rate. The results of the adjustment task are expressed as the number of successful adjustments out of twenty. Expert #1 estimated that he didn't need help during the second double task. Expert #4 chose the "strictly automatic" mode during the second double task.

Task \ Expert		Expert 1	Expert 2	Expert 3	Expert 4	Expert 5
Pentagon classification		84.33 %	84.21 %	79.92 %	84.61 %	84.61 %
Temperature adjustment		12/20	14/20	19/20	2/20	10/20
Double task without HETI	Pentagon classification	81.57 %	86.84 %	84.17 %	10.25 %	92.30 %
	Temperature adjustment	16/20	15/20	17/20	3/20	13/20
Double task with HETI	Pentagon classification	81.57 %	89.47 %	94.87 %	92.30 %	82.05 %
	Temperature adjustment	14/20	17/20	14/20	20/20	15/20
Remarks concerning the behaviour of the experts		Second double task in "strictly manual" mode	Second double task in "HELP" mode, then "HETI activated" mode when the pentagon frequency increases	Use of the "HELP" mode at the end of the second double task	Use of the "Urgent stop" during the simple task and the first double task. "Strictly automatic" mode during the second double task.	"HELP" mode during the second double task ; HETI activated without continuity, then HETI continuously activated when the pentagon frequency increases

When the HETI is in the "momentary" mode and the expert does not act upon the process, the resulting performance is 20/20. The same results are obtained in "help" mode when the expert applies the suggested command. Behavioural differences induced variations in the experts' results. Indeed, each expert selected the HETI mode according to his own self-confidence about the task. However, each individual sometimes overestimated his/her potential performance.

5.2. Main results of the evaluation

The experts' comments can be divided into three categories.

Comments on the tasks included the difficulty of visualising circuit input and output at the same time, the difficulty of integrating dispenser functions, insufficient training, and the lack of real-time constraints and performance indication, which would have been more challenging.

Comments on the execution of the tasks included the difficulty of finding a heuristic or a function rule that would allow prediction of, rather than mere reaction to, each change in the input/output, the impossibility of getting a global view of the process, the difficulty of keeping one's mind on the priorities (even though subjects were required to give priority to the pentagon-classification task) and too much reading in the "help" mode to be able to react quickly, increasing the mental overload with the speeding-up of the pentagons' appearance rate.

Whenever help could be invoked, it was appreciated, especially in the "active help" mode, because this allowed a lightening of the workload, while leaving subjects with a sense of accomplishment. There were no comments or suggestions about this help mode, except about the information display. After the experiment, the experts were asked to complete a questionnaire and give suggestions about the experiment.

The experts considered the experiment from different points of view, according to their own fields. Their comments included synopsis of the ergonomics and the degree of difficulty of the tasks, and not always direct comments on the usefulness and potential of the HETI. The tasks were designed precisely in order to provoke mental overload, and this is why training was limited and more time was needed to evaluate and execute the tasks; thus the desired overloading effects were achieved. However, the experts did not really evaluate the actual usefulness of the HETI, which seemed obvious to them.

The experts had striking differences in behaviour, as indicated in Fig. 18. Some were so enthralled by the tasks that they disregarded the HETI in order to concentrate on their performance. Three of the experts did not even use the HETI, either because they presumed that they could do the task without help, or because they activated it too late, or because they preferred to concentrate, almost solely, upon pentagon classification.

This indicates that experts, when faced with an unfamiliar process, have unpredictable behaviours. This was the converse of the beginner subjects, who based their actions solely on their training and the stimulation they received, thus following the commands more closely. The experts appeared not to follow a simple deductive reasoning process but to execute seemingly thoughtless actions, eventually losing track of the task at hand. Contrary to accepted ideas, the experts did not make any fewer errors than the beginners, except those caused by lack of knowledge (Prümper et al., 1992). However, they spent less time correcting these errors, once discovered.

At this point, the facts described above go beyond the bounds of automation, the field in which this study was done. Instead, they belong to cognitive psychology and ergonomics.

6. Conclusion

With this specific type of industrial process, the use of fuzzy logic for human operator modelling seems to be a promising choice. The fuzzy-logic operator model was designed using an analysis of the best operator's actions after preliminary experiments; it includes both general and fine tuning.

In the "strictly automatic" mode, the controller designed in this way carried out perfect adjustments in every operating configuration. In the "temporary" modes, the efficiency of the human operator using the HETI increases, thanks to the HETI.

The HETI is basically composed of a human operator model and a solution module. Its validation by experts in human-machine interaction has shown, however, that some experts have unpredictable attitudes towards the help system. Some do not activate the system, or activate it too late. Such attitudes may be related to each expert's own perceived capacity to take control over the process and are comparable to the "no-risk" and "high-risk" behaviours found during the primary

stages of the experiment. This indicates a strong need for training and more adaptation time for most of the human operators using a HETI.

Several perspectives are opened by this preliminary study, concerning:

- the necessity to undertake other technical and ergonomic evaluations with experts and novice operators, with different types of industrial processes,
- the analysis of a manual take-over after control of a process by the HETI,
- the use of non-optimal human operator models for the making of the HETI,
- the development of a module that is able to identify the intentions of a human operator during specific tasks.

References

- Beka Be Nguema, M., Waroux, D. and Malvache, N. (1993). Contributing to the design of a human error tolerant interface during the control of a simple simulated industrial process. *Proceedings 12Th European Annual Conference on Human Decision Making and Manual Control*, Kassel, Germany, June 22-24.
- Beka Be Nguema, M. (1994). *Comportement de l'opérateur humain face à une situation dégradée et imprévue: contribution à la réalisation d'une interface homme-machine tolérante aux erreurs humaines*. Ph.D, University of Valenciennes, December.
- Benhalima, D.E. and Malvache, N. (1992). Experimental protocol design system based on object-oriented approach: application to graphical communication. *Proceedings Conference and Exhibition on Industrial Automation*, Montreal, Canada, 1-3 June.
- Bouroche, J.M. and Saporta, G. (1980). *L'analyse des données*. Presses Universitaires de France. Collection Que sais-je?, fourth edition.
- Buckley, J.J. and Ying, H. (1991). Expert fuzzy controller. *Fuzzy sets and systems*, 44, 373-390.
- Cacciabue, P.C., Mancini, G. and Bersini, U. (1990). A model of operator behaviour for man-machine system simulation. *Automatica*, 26 (6), 1025-1034.
- Coonan, T.A.(1986). An error tolerant interface using operator and system models. *IEEE-CH2364-8186*.
- Desombre, L., Malvache, N. and Vautier, J.F. (1995). Graphic communication and human errors in a vibratory environment. *Proceedings 6th IFAC/IFIP/IFORS/IEA Symposium on Analysis, Design and Evaluation of Man-Machine Systems*, Cambridge, MA USA, 27-29 June.
- El Mechrafi ,Y. and Malvache, N. (1991). Analysis of human decision making in interaction with a team-mate during a classification task. *Proceedings Tenth European Annual Conference on Human Decision Making and Manual Control*, Liège, Belgium, November.
- Grais, B. (1992). *Méthodes statistiques*. Editions DUNOD, Paris.
- Guerra, T.M. (1991). *Analyse de données objectifo-subjectives: approche par la théorie des sous-ensembles flous*. Ph.D, University of Valenciennes, July.

- Hancock, P.A. and Chignell, M.H. (Eds). (1989). *Intelligent interfaces: theory, research and design*. North Holland, Amsterdam.
- Hollnagel, E. (1989). The design of fault tolerant systems: prevention is better than cure. *Proceedings 2nd European Meeting on Cognitive Science Approaches to Process Control*, October 24-27, Siena, Italy.
- Hollnagel, E. (1994). *Human reliability analysis, context and control*. Academic Press, London.
- Kaufmann, A. (1972). *Introduction à la théorie des sous-ensembles flous - Tome I: éléments théoriques de base*. MASSON, Paris.
- Kolski, C., Le Strugeon, E. and Tendjaoui, M. (1993) Implementation of AI techniques for "intelligent" interface development. *Engineering Applications of Artificial Intelligence*, 6 (4), 295-305.
- Kolski, C. (1997). *Interfaces homme-machine, application aux systèmes industriels complexes*. Editions HERMES, Paris.
- Kolski, C. and Le Strugeon, E. (1998) A Review of "intelligent" human-machine interfaces in the light of the ARCH model. *International Journal of Human-Computer Interaction*, 10 (3), 193-231.
- Laprie, J.C. et al. (1995). *Guide de la sûreté de fonctionnement*. Cépaduès Editions, Toulouse.
- Leplat, J. (1985). *Erreur humaine, fiabilité humaine dans le travail*. Armand Colin, Paris.
- Louas, Y., Desombre, L. and Malvache, N. (1998). Human behavior assessment method for a detection task performed in a stressful environment. *Proceedings 17th European Annual Conference on Human Decision Making and Manual Control*, Valenciennes, France, December.
- Masson, M. and De Keyser, V. (1992). Human errors learned from field study for the specification of an intelligent error prevention system. In S. Humar (Ed.), *Advances in Industrial Ergonomics and Safety IV*, 1085-1092, Taylor and Francis.
- Masson, M. (1994). *Prévention automatique des erreurs de routine*. Ph.D. Thesis in Psychology, University of Liège, Belgium, July.
- Molich, R. and Nielsen, J. (1990). Improving a human computer dialogue. *Communications of the ACM*, 33, 338-348.
- Nielsen, J. (1993). *Usability engineering*. Academic Press.
- Norman, D.A. (1983). Design rules based on analysis of human error. *Communications of the ACM*, 26 (4), 254-258, April.
- Ombredane, A. and Faverge, J.M. (1955). *L'analyse du travail*. Paris, PUF.
- Pedrycz, W. (1989). *Fuzzy control and fuzzy systems*. Research Studies Press, John Wiley & Sons Inc.
- Prümper, J., Zapf, D., Brodbeck, F.C. and Frese, M. (1992). Some surprising differences between novice and expert errors in computerized office work. *Behaviour and Information Technology*, 11 (6), 319-328.

- Rasmussen, J. (1986). *Information processing and human-machine interaction, an approach to cognitive engineering*. Elsevier Science Publishing.
- Rasmussen, J. and Vicente, K.J. (1989). Coping with human errors through system design: implications for ecological interface design. *International Journal of Man-Machine Studies*, 31, 517-534.
- Reason, J. (1990). *Human Error*. Cambridge University Press, Cambridge.
- Rouse, W.B. and Rouse, S.H. (1983). Analysis and classification of human error. *IEEE transactions on systems, man and Cybernetics*, SMC-13, 539-549.
- Rouse, W.B and Morris, N. (1985). Conceptual design of human error tolerant interface for complex engineering systems. *Proceedings 2nd IFAC/IFIP/IFORS/IEA Conference on Analysis Design and Evaluation of Man Machine Systems*, Varese, Italy, September.
- Schneider-Hufschmidt, M., Kühme, T. and Malinkowski, U. (Eds) (1993). *Adaptive User Interfaces*. North Holland.
- Senders, J.W. and Moray, N. (1991). *Human error, cause, prediction and reduction*. Lawrence Erlbaum Associates Publishers.
- Shaw, I.S. (1993). Fuzzy model of a human control operator in a compensatory tracking loop. *International Journal of Man-Machine Studies*, 38, 305-332.
- Sperandio, J.C. (1972). *Charge de travail et variation des modes opératoires*. Thèse de Doctorat d'Etat en Psychologie, Université de Paris V, France.
- Sugeno, M. and Nishida, M. (1985). Fuzzy control of a model car. *Fuzzy sets and systems*, 16, 103-113.
- Swain, A.D. and Guttman, H.G. (1983). *Handbook of human reliability analysis with emphasis on nuclear power plant applications*. US Nuclear regulatory commission technical report Nureg/Cr 1278.
- Yager, R.R. and Filev, D.P. (1994). *Essentials of fuzzy modeling and control*. Wiley, Chichester.
- Wilson, J.R. and Corlett, E.N. (Eds) (1996). *Evaluation of human works, 2nd edition*. Taylor and Francis.
- Zadeh, L.A. (1965). Fuzzy sets. *Information and Control*, 8, 338-353.