



HAL
open science

Joint production and preventive maintenance controls for unreliable and imperfect manufacturing systems

Abdessamad Ait El Cadi, Ali Gharbi, Karem Dhouib, Abdelhakim Artiba

► To cite this version:

Abdessamad Ait El Cadi, Ali Gharbi, Karem Dhouib, Abdelhakim Artiba. Joint production and preventive maintenance controls for unreliable and imperfect manufacturing systems. *Journal of Manufacturing Systems*, 2021, 58, pp.263-279. 10.1016/j.jmsy.2020.12.003 . hal-03396958

HAL Id: hal-03396958

<https://uphf.hal.science/hal-03396958v1>

Submitted on 18 Sep 2024

HAL is a multi-disciplinary open access archive for the deposit and dissemination of scientific research documents, whether they are published or not. The documents may come from teaching and research institutions in France or abroad, or from public or private research centers.

L'archive ouverte pluridisciplinaire **HAL**, est destinée au dépôt et à la diffusion de documents scientifiques de niveau recherche, publiés ou non, émanant des établissements d'enseignement et de recherche français ou étrangers, des laboratoires publics ou privés.

Joint production and preventive maintenance controls for unreliable and imperfect manufacturing systems

Abdessamad Ait El Cadi ^a, Ali Gharbi ^{b,*}, Karem Dhoub ^c, Abdelhakim Artiba ^a

^a *Laboratory of Industrial and Human Automation Control, Mechanical Engineering and Computer Science (LAMIH UMR CNRS 8201), Université Polytechnique Haut-de-France (UPHF), Valenciennes, France*

^b *Production System Design and Control Laboratory, Systems Engineering Department, École de Technologie Supérieure, University of Quebec, Montreal, QC, Canada* ^c *Laboratory of Mecanics, Productique, and Energy (LMPE), École Nationale Supérieure d'ingénieurs de Tunis (ENSIT), Université de Tunis, Tunis, Tunisia*

ABSTRACT

Joint production system control is a challenge for researchers and a daily defy for managers and practitioners. The large concern comes from the interdependence between the system states and the control actions. Several analytical models have addressed these issues but remain inefficient because they are based on many simplifying assumptions for mathematical tractability (mainly concerning the system degradation mode). This is critical because degradation modeling impacts the overall manufacturing system and leads to an over or an under estimation of its performance. In this paper, we propose an efficient stochastic analytical model of integrated production and preventive maintenance control for manufacturing systems subject to operation-dependent degradations of both reliability and quality. A make-to-stock production strategy and an age-based preventive maintenance policy are employed to cope with uncertainty. The main objective is to jointly optimize the production and maintenance control settings by minimizing the total incurred cost. A simulation model is also developed to validate the mathematical model. Numerical examples and a detailed sensitivity analysis are provided to assess the quality of our model and to derive relevant insight and issues regarding the interaction between production, maintenance, and quality.

Keywords:

Production control
Preventive maintenance
Operation-dependent degradation
Reliability and quality degradation
Mathematical modeling
Simulation

1. Introduction and context

The integration of production and Preventive Maintenance (PM) to control manufacturing systems subject to degradation has attracted a great deal of attention among scientists in the last two decades [27]. Research in this area is motivated by the fact that integrated control policies result in better manufacturing performance as compared to traditional planning approaches, where production and maintenance are treated as separate problems [16]. For instance, it has been shown that integrated control models can theoretically lead to an increase of up to 40 % in profit [17]. However, implementing integrated control models in real-life is challenging as they are based on several unrealistic assumptions that make them impractical.

In lean manufacturing systems, the operating speed is aligned with the demand rate, which leads to low inventory levels. However, in degrading manufacturing systems, a safety stock is generally used to protect the system against the risk of shortage when machines are not available. Nevertheless, building a safety stock requires an extra

production capacity accelerating the production rate and increasing the degradation intensity [25]. To restore and maintain the overall reliability and the quality performance, corrective and planned maintenance actions are required [4,5]. Hence, an effective integrated operation control for degrading systems should take into consideration these complex interactions between production, inventory, reliability and quality, as in real life.

In the present paper we study the joint design of production and maintenance control policies for manufacturing systems subject to operation-dependent degradations of reliability and quality. We are dealing with a continuous production system, compound of three stations: production, inspection, and rectification. The failure rate and the fraction of defectives are increasing with the system age. The quality screening is done by inspecting 100 % of the manufactured parts. The proposed approach stands on two main pillars: 1) a realistic and complete mathematical model; we relax several assumptions found in the literature: no restriction on probability distributions, failures allowed during safety stock building phase, non-negligible inspection and

* Corresponding author.

E-mail addresses: abdessamad.aitelcadi@uphf.fr (A. Ait El Cadi), ali.gharbi@etsmtl.ca (A. Gharbi).

rectification durations and costs, reliability and quality degradations are operation-dependent. 2) a fine-tuned signal-based continuous simulation model which allows fast runtime and accurate results. The results from the simulation model validate the proposed analytical model and show its effectiveness and accuracy.

The paper is organized as follows. In Section 2, we present a literature review covering integrated production and PM policies. Section 3 describes the manufacturing system under study. In Section 4, we formulate the mathematical model. Section 5 develops the simulation model used to validate the proposed mathematical model. Numerical examples, a sensitivity analysis and a comparative study of analytical solutions with simulation are given in Section 6; An extension of our model to the cases with imperfect preventive maintenance and inspection errors is developed in section 7. Finally, Section 8 concludes the paper.

2. Literature review

Integrated production and PM models in the literature can be classified into two main categories depending on the type of production system. The first category is comprised of batch processing systems and consists in integrating the Economic Production/Manufacturing Quantity (EPQ/EMQ) problem with different PM strategies [22,24,32,33,36,45,44]. These models generally solve the problem at tactical level on a given horizon. They assume that the production rate is fixed per period and harmonize PM intervention operations [18]. The second category concerns continuous flow production systems, where the production rate is generally considered variable [19]. Integrated production and PM models can also be classified based on whether or not quality degradation is considered [27]. This paper deals with the second category of integrated production control systems.

In recent years, there has been a surge interest in incorporating the quality degradation aspect into integrated production and PM models. Radhoui et al. [38] proposed an integrated production and PM control policy considering a 100 % inspection and assuming that feedback information from inspection is used to improve PM planning. Rivera-Gomez et al. [42,43] used a numerical approach to estimate the optimal production and PM control parameters for single unit production systems subject to degradation. Recently, Bouslah et al. [10] developed simulation models integrating the HPP, age-based PM and continuous sampling plan for manufacturing systems subject to operation-dependent degradation. To the best of our knowledge, there is no analytical model in the literature that jointly optimizes the production and PM control policies for systems where reliability and quality are subject to operation-dependent degradation.

In this context, Boukas and Yang [8] introduced what is most probably the first analytical model for simultaneous production and PM control for continuous flow manufacturing systems. The optimal control policy obtained is of the type hedging point policy (HPP). Cheung and Hausman [14] presented another analytical model of PM and safety stock strategies for an unreliable production system. This model has been reviewed and extended by Dohi et al. [20] to the case where maintenance periods follow a Weibull distribution. Kenne and Gharbi [28] proposed an integrated model combining the hedging point policy with PM for stochastic single-machine systems subject to operation-dependent reliability degradation. They used a simulation-based optimization approach to optimize control parameters. Berthaut et al. [6,7] integrated the HPP with various modified PM strategies resulting in better PM planning and cost reduction.

Basically, inventory and preventive maintenance are always required to cope with uncertainty in manufacturing systems due to aging and degradation [7,39]. Nevertheless, degradation, which is a complex phenomenon impacting both machine reliability and product quality, has not been properly modeled in the literature of production control policies to mimic the real behavior of manufacturing systems.

On the one hand, one common assumption used is that the reliability

degradation of machines is time-dependent [3,34,23], whereas, in real life, most machine failures are operation-dependent [9,19,11]. This assumption is prevalent in the literature because, analytically, modeling operation-dependent failures is much more complex than modeling time-dependent ones [30]. In fact, when modeling operation-dependent failures, only the time during which the machine is operational needs to be tracked. However, it has been shown that modeling machines assuming a time-dependent failure approach may lead to a significant underestimation of overall production capacity [31].

On the other hand, the degradation modeling of product quality in integrated control policies is based also on many simplifying assumptions. Currently, the defective rate is considered constant, following a known probability distribution, or following a time-dependent deterioration model [12,13,29,37,49]. These assumptions completely ignore the fact that quality degradation in manufacturing systems is directly and intrinsically affected by the speed of operations. For example, this has been seen in machining processes when increasing the cutting speed accelerates the tool wear and deteriorates the quality of machined surfaces [35]. In Rapid prototyping technologies and particularly in Solid Ground Curing (SGC) process, it has been shown that the quality of a SGC prototype is affected by the operation speed; the operation speed may influence both surface quality and prototype properties [26].

Table 1 summarizes a comparison of our proposed approach to the most relevant works in the literature. The comparison is based on the key features of the studied problem, such as the considered policies, type of degradation, and inspection strategy. We do compare also the approaches used to model and solve the problem by highlighting if the work uses a simulation and/or analytical model. Mainly, few works consider the operation-dependent degradation of the system, and fewer consider the inspection and rectification durations. We also note that many mathematical models do not allow failures during safety stock building phase.

The major conclusions from this literature review is that while the joint design of production and maintenance control is valuable, integrated mathematical models are nonetheless too difficult to address real-life problems. Difficulties arise from the stochastic character of the problem and the complex analytical formulation (many stochastic integrals, non-explicit functions, etc.). To deal with these limitations, authors either use simplifying assumptions in their mathematical models (example: no failure during the safety stock building phase, negligible inspection and rectification durations, time-dependent degradations) or they use simulations. In the first case, assumptions could lead to incorrect results, and no work has proven the effectiveness of these assumptions in all conditions. For the second case, the computing effort is high. Simulations take long time to run, and many runs are needed when it is combined with optimization techniques.

3. Problem description

The system under study is an automated manufacturing cell consisting of three stations, as illustrated in Fig. 1. Station 1, the “Machine”, is dedicated to producing a single product type to satisfy a constant and a continuous demand. Station 2, “the inspection”, is used to inspect the quality of all produced items (100 % inspection policy). Station 3, “the rectification”, is devoted to reworking the parts declared as defects by the inspection.

The manufacturing machine produces at rate u , which depends on the stock level. Each unit leaves this machine and enters the inspection station for T_{insp} units of time. After inspection, the product is either good, and goes to the final product stock, or defective, and is then reworked through a rectification center during T_{rect} units of time before ending up at the final product stock. Therefore, the final product stock is fed by two flows: “Flow 1” of good parts, coming directly from the inspection, and “Flow 2” of reworked parts (Fig. 1). The latter flow is delayed by T_{rect} units of time. This stock holds final products to satisfy outside demand, at a rate d .

Table 1
Bibliographic review of the most relevant works to this research.

Author(s)	Multistage system	Deteriorating system	Deteriorating quality	operation-dependent degradation	Failure during safety stock building phase	Non-negligible inspection duration	Non-negligible rectification duration	Production policy	Maintenance strategy	Stochastic context	Analytical approach	Simulation approach	Analytical approach validation
Ait El Cadi et al. (2016)	x			x	x					x		x	
Assid et al. (2019)	x	x		x	x			x		x		x	
Bouslah et al. (2016)	x	x	x	x	x	x		x	x	x		x	
Bouslah et al. (2018)	x	x	x	x	x	x		x	x	x		x	
Chakraborty and Giri (2012)		x			x			x		x	x		
Colledani and Tolio (2011)		x		x						x	x		
Colledani and Tolio (2012)		x		x		x			x	x	x		
Dellagi et al. (2017)		x			x			x	x	x	x		
Dhouib et al. (2008)	x	x		x				x		x	x	x	x
Ouaret et al. (2018)	x	x	x	x	x			x	x	x	x		
Rezg et al. (2008)		x						x	x	x	x		
Radhoui et al. (2010)		x							x	x	x		
Rivera-Gómez et al. (2018)		x	x	x	x			x	x	x	x	x	
Rivera-Gómez et al. (2019)		x	x	x	x			x	x	x		x	
Polotski et al. (2015)		x			x			x		x	x		
Xao et al. (2019)		x	x					x	x	x	x		
Proposed approach	x	x	x	x	x	x	x	x	x	x	x	x	x

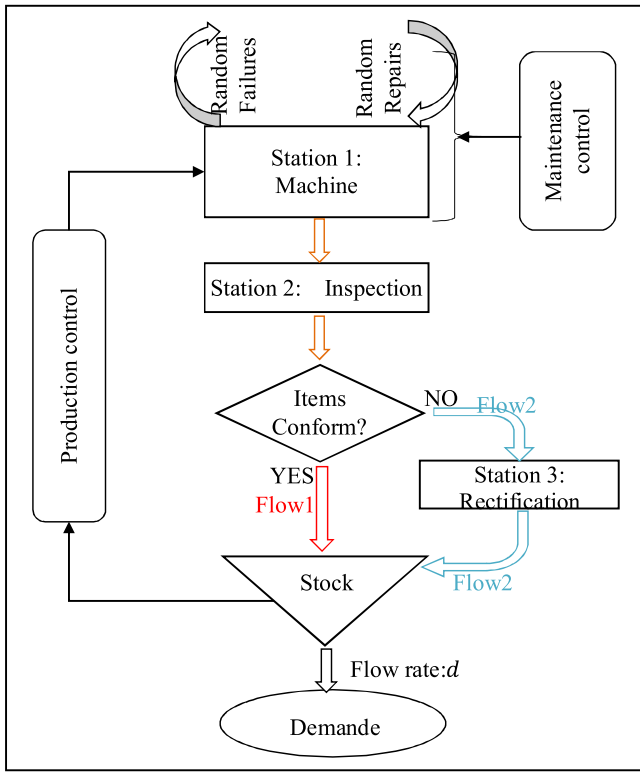

Fig. 1. Manufacturing system under study.

The machine failure and the product quality are operation-dependent. The usage of the machine (how it is operated, with which speed, idle versus busy periods, number of stops, and the amount of work) is the main factor of degradation. We consider the age of the machine as a function of the number of units produced, which is different from the clock time. This approach takes into account the operating speed, the idle, the busy and the stopping periods. Consequently, the increase in the machine age leads to an increasing failure rate and an increasing proportion of defective products.

We adopt, for the maintenance, an Age-Based Preventive Maintenance (ABPM) to dodge unexpected breakdowns. However, failures can occur, and consequently corrective maintenance interventions (CM) are carried out. Both PM and CM bring back the system to the “as good as new state”. The production rate should be adjusted to meet demand.

The 100 % inspection policy ensures the delivery of defect-free products to consumers. Products with defects are reprocessed through a rectification center and then sent to the final stock as defect-free products. Inspection and rectification times are considered non-negligible. Unfulfilled sales are lost.

The problem is to jointly optimize the production and maintenance control policies under quality and reliability degradations. The objective is to minimize the total cost incurred over the long term. This cost includes the inventory holding cost, the lost sales cost, the CM and PM costs, and the inspection and rectification costs.

4. Mathematical model

In this section, we first present the contextual conventions, notations, and used assumptions. Second, we detail the mathematical model of the problem. Third, we present the formulation of the total incurred cost per unit of time.

The following approach is used: (1) we model the cost function as a “renewal-reward process”. (2) This leads to the expression of the objective function as the average cost over a cycle divided by the average length of a cycle. (3) We compute the optimal strategy. (4)

Finally, we develop a simulation model to validate the analytical results (section 5).

We model the rectification process, as well as its impact on the evolution of the buffer level. Due to the rectification process duration, a part of the buffer changing rate is delayed by T_{rect} which makes the buffer level a nonlinear function. We also consider the general case of probability distribution in order to make the model more realistic and mimics real-life conditions.

To achieve this comprehensiveness and accurateness, we model the system’s metrics as stochastic processes, “renewal-reward process”, and use calculus techniques such as “Integration by Parts”, “decomposition” and “Substitutions”, which allow back and forth movement between the age variable and the time variable. Hence, we were able to express the key performance indicators (such as the accumulated inventory) differently, making it easier to handle the equations and to overcome the underlying complexity of the calculation.

4.1. Notations

We list below the notations used in the rest of the paper: Z safety stock level, the maximum level of storage; S_{max} maximum storage level during a given cycle; we have $S_{max} \leq Z$. $S_{max} = Z$ if there is no failure during the safety stock building phase; T_{insp} inspection time duration; T_{rect} rectification time duration; a age of the machine; expressed in the number of manufactured parts; a_{rect} age of the machine T_{rect} units of time before (i.e., for parts leaving rectification); $p(a)$ proportion of defects caused by machine at age a ; $q(a)$ proportion of good parts produced by the machine at age a . $Q(a) = \int_0^a q(x) dx$ total good parts produced up to age a ; $Q(a) = \int_0^a q(x) dx$; U_{max} maximum production rate; d demand rate; M maintenance period in terms of usage; A_f age of the machine at failure; t_r repair duration; t_m maintenance duration; T_M instant at which maintenance becomes due; T_e time needed to empty buffer after a failure; T_f instant of failure; T_z instant at which the buffer becomes full; f_x density function of random variable x ; F_x cumulative distribution function of random variable x ; $M_{i,x}^{(a)}$ i th order lower partial moment of x ; C_h inventory holding cost per time unit; C_l cost of one unit of lost sales; C_{pm} preventive maintenance cost; C_{cm} corrective maintenance cost; C_{insp} inspection cost; C_{rect} rectification cost

4.2. Assumptions

The problem under consideration is modelled under the following conventions:

- 1 Both preventive and corrective maintenance are perfect; after each action, the system is brought back to the state “as good as new”. Indeed, we suppose a perfect maintenance and reparation as it is widely used and accepted in the community. As stated in the “Handbook of reliability engineering”, the perfect maintenance is the case in the major studies [10,13,17,18,20,38,39,49]. An extension to imperfect maintenance is addressed in the section 7 of the present paper.
- 2 The inspection plan is 100 %; in fact, we inspect all items.
- 3 The quality inspection is error-free, so that all defective items are sorted and reworked. As the studied system is an automated one, we suppose that the screening is perfect. An extension with the two types of error in the inspection process is presented in the section 7.
- 4 Degradations of the system Reliability and Quality are operation-dependent. This assumption is realistic since in real life most machine failures are operation-dependent [9,19,11].
- 5 After each maintenance action, PM or CM, if the buffer size is negative the machine starts immediately; otherwise we wait until the buffer is empty before restarting the production. This assumption is reasonable since after a PM or CM action the machine is “as good as

new”, and consequently there is no need to build a safety stock. Furthermore, this makes the system lean and avoids to stock when it is not necessary.

One can note that assumptions 1, 2, 3, and 5 are considered in the majority of works about joint production and maintenance control policies.

4.3. Production, maintenance, and quality control policy

Let us consider a manufacturing system as described in Fig. 1. The dynamic of this system depends on the production machine age a , which for its part depends on the time.

The inspection phase has a non-negligible duration that affects the dynamics of the system. As all parts are inspected, the first impact is the delay of T_{insp} units of time imposed to the flow coming out from the machine. The second is an extra “work in progress” in the corresponding station. The rectification phase also has a non-negligible duration, which affects the evolution of the final buffer level. As shown in Fig. 1, “Flow 2” is delayed, as compared to “Flow 1”.

The production rate u of the manufacturing machine is controlled through the so-called hedging point policy (HPP) presented in Akella and Kumar [2]. Eq. (1) gives the proposed production control policy.

$$u = \begin{cases} U_{max} & \text{if } s < Z \text{ \& machine up} \\ d & \text{if } s = Z \text{ \& machine up} \\ 0 & \text{if } s > Z \text{ or machine under maintenance} \end{cases} \quad (1)$$

The manufacturing machine has two states:

- UP, the machine is working and producing parts at a given rate u .
- DOWN, the machine is not working and its production rate equals 0 under preventive or corrective maintenance.

The maintenance control policy is realized through an age-based preventive maintenance where the age is operation-dependent. As presented in Eq. (2), if the total number of produced units is equal to M (the maintenance threshold), the machine is stopped to allow a preventive action.

$$PM = \begin{cases} no & \text{if } a < M \\ yes & \text{if } a = M \end{cases} \quad (2)$$

This policy is used to mitigate failure impacts. After each maintenance action, PM or CM, the machine is returned back to the “as good as new state”. If the buffer level s is negative, the machine starts immediately; otherwise, it waits until the buffer is empty before restarting production. Indeed, since the machine is “as good as new”, there is no need to build a safety stock immediately.

The buffer state is described by its level $s \in] - \infty, Z]$. When this level is positive, there is a surplus, $s^+ = \max(s, 0)$, and the negative level indicates lost sale, $s^- = \max(-s, 0)$. The inspection and the rectification operations with durations T_{insp} and T_{rect} modify the evolution of the buffer level; the buffer construction rate is composed of three flows (Eq.

(3)): two ingoing flows from the inspection (good parts) and from the rectification stations, with rates $q(a).u(a)$ and $p(a_{rect})u(a_{rect})$, respectively, and one outgoing flow representing the demand with a constant rate d .

$$\frac{ds}{dt}(t + T_{insp}) = [q(a(t)).u(a(t)) + p(a(t - T_{rect}))u(a(t - T_{rect}))] - d \quad (3)$$

4.4. System cycles and cost as a renewal-reward process

The state of the machine goes episodically from UP to DOWN and from DOWN to UP. Fig. 2 shows the machine cycles, which include three parts: (1) UP of length t_f (failure) or the time needed to produce M units (PM); (2) DOWN of length t_r or t_m ; (3) the waiting time to empty the final product buffer, if applicable.

The buffer state has also three cycles according to the machine cycles (Figs. 3–5); it is characterized by the buffer level $s(t) \in] - \infty, Z]$. Figs. 3, 4, and 5 show, clearly, that the buffer size is equal to zero, both at the beginning and at the end of each cycle. From these observations, we are sure that the underlying stochastic process is a renewal process due to the independence between cycles. In fact, the holding times T_i of the process (lengths of each $Cycle_i$) are independent and identically distributed. This is because at the beginning of each cycle, the system starts with the same states: a new machine and an empty buffer.

Therefore, any KPI (key performance indicator) computed over each $Cycle_i$ (KPI_i) is a “reward” and, its cumulative, over a horizon t , is a “renewal-reward process”.

The main KPIs related to the evaluation of the production system described above are:

- T_i : length of $Cycle_i$
- WIP_i : cumulative inventory for final product during $Cycle_i$
- $Loss_i$: lost sales during $Cycle_i$
- $Cost_i$: total cost during $Cycle_i$
- $NbPM_i$: number of preventive maintenances during $Cycle_i$
- $NbCM_i$: number of corrective maintenances during $Cycle_i$
- $NbInsp_i$: number of inspections done during $Cycle_i$,
- $NbRect_i$: number of rectifications done during $Cycle_i$,
- $InsRectWIP_i$: cumulative WIP (work-in-progress) in the inspection and rectifications shop during $Cycle_i$,

Consequently, to compute the average value of a specific KPI per unit of time over an infinite horizon, we apply “the elementary renewal theorem for renewal reward processes” [15], which means:

$$\lim_{t \rightarrow \infty} \frac{KPI(t)}{t} = \frac{E[KPI_i]}{E[T_i]} \quad (4)$$

4.5. Performance evaluation over a given cycle

The aim of this work is to find the optimal control parameters of the manufacturing system. In other words, to find the maintenance threshold M and the maximum storage level Z that minimizes the total incurred cost over an infinite horizon.

In this section, we will compute the KPIs and then the total cost of the manufacturing system in order to find the optimal control parameters (Z ,

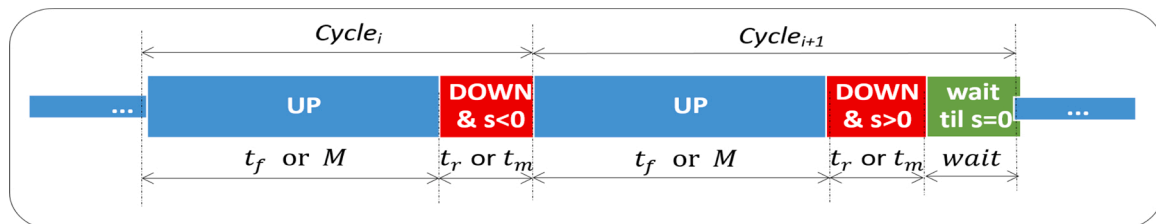

Fig. 2. Machine’s cycles.

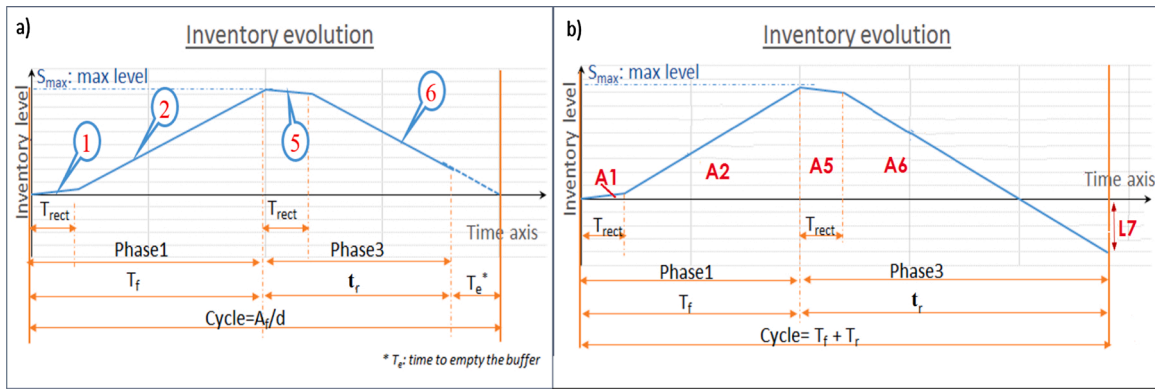

Fig. 3. Case 1, $A_f \leq A$.

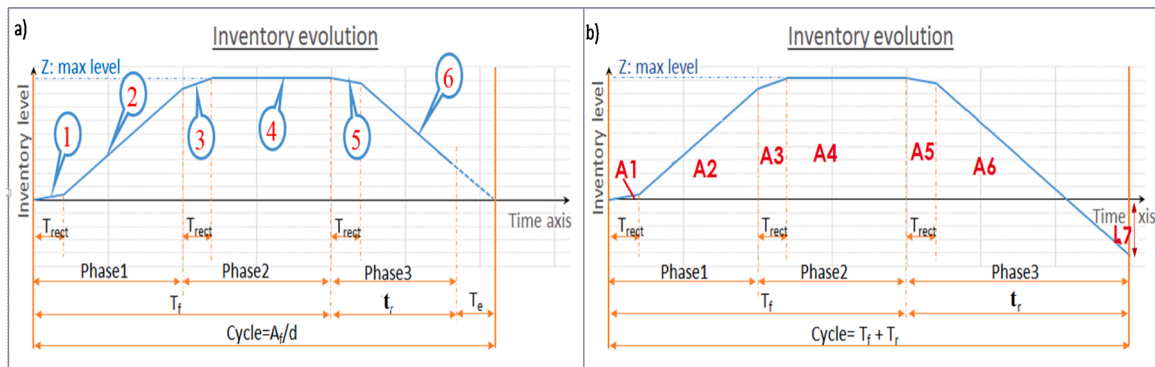

Fig. 4. Case 2, $A \leq A_f \leq M$.

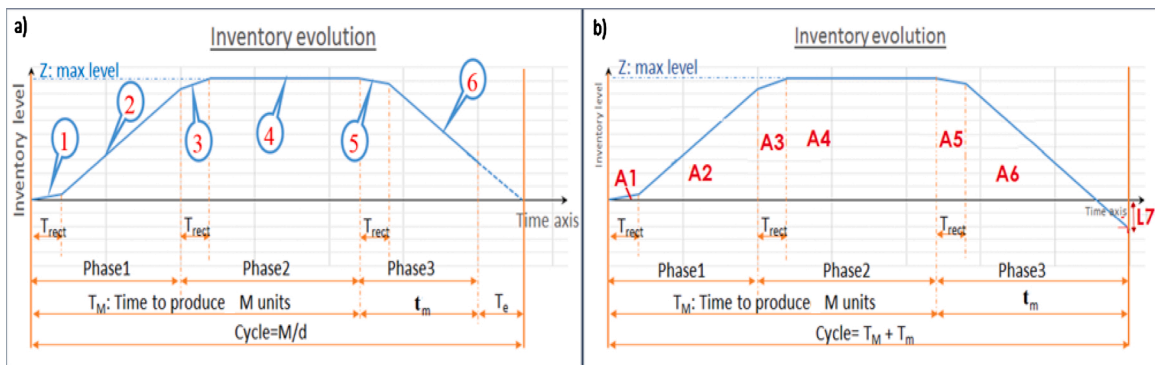

Fig. 5. Case 3, $M \leq A_f$.

M) that minimize this cost.

During any given cycle, the system could pass through three phases or less. The possible phases are:

- Phase 1 “*Inventory building phase*”: the machine is producing at a maximum rate.
- Phase 2 “*Production at Demand phase*”: once the buffer is full ($s = Z$), the production rate is slowed down to meet the demand rate.
- Phase 3 “*Restoration phase*”: after a failure or a certain age (production of M units), we restore the machine to the “as good as new” state, either correctively or preventively.

Subsequently, depending on the instant of occurrence of the failure, i.e. during which particular phase (1 or 2), the system will have three

different types of cycles:

- Cycle of type 1: Failure occurs before the buffer is fully built, i.e., during phase 1. This kind of cycle is characterized by $A_f \leq A$ and $S_{max} < Z$, as in Fig. 3.

Where A is the machine age at which the buffer is full ($s = Z$):

$$A = U_{max} \frac{Z}{(U_{max} - d)} \quad (5)$$

- Cycle of type 2: Failure occurs after the buffer is full and before the maintenance due age M , i.e., during phase 2. This kind of cycle is characterized by $A < A_f \leq M$ and $S_{max} = Z$, as in Fig. 4.

- Cycle of type 3: No failure occurs before the maintenance due age M , i.e., during phase 3. This cycle is characterized by $M < A_f$ and $S_{max} = Z$, as in Fig. 5.

Figs. 3, 4, and 5 present two possible situations: (a) the left side indicates the situation where the machine repair ends before the buffer is empty. There are no lost sales and the cycle restarts again when the buffer is empty. (2) The right side shows the situation where the buffer is empty before the machine repair ends; there are some lost sales and the cycle restarts immediately after the machine repair. The occurrence of the two situations depends on the repair time and the buffer level: Situation 1 occurs if $t_r < S_{max}/d$ ($t_m < S_{max}/d$) after a corrective repair (a maintenance action), and S_{max} is either Z if failure occurs after the safety stock is built or $\left(\frac{A_f(U_{max}-d)}{U_{max}}\right)$ otherwise.

4.5.1. Study of the system dynamic represented by the buffer level

As all manufactured parts are inspected, they are delayed by T_{insp} . The buffer level in Figs. 3–5 is then shifted by T_{insp} . Conversely, the rectification process affects the buffer level evolution because only the bad parts are delayed by T_{rect} . Consequently, the buffer level experiences many more changes than in the classical case with no rectification. In Figs. 3a, 4a and 5a, we labeled all the chunks of the curve representing the changes in the buffer level function with numbers ranging from 1 to 6. In addition, in Figs. 3b, 4b and 5b, and to illustrate the average inventory, we tagged the areas between the buffer level curve and the time axis as A1 to A6. Also the lost sales are marked by the value $L7$ in these figures.

The dynamic of the buffer level, due to the changes in the production rate $u(a)$, the production quality $p(a)$, and the offset between the two ingoing flows (caused by the rectification), explains the changes in the curves in Figs. 3–5. The curve in Fig. 3a has four segments labeled 1, 2, 5 and 6:

- Segment 1 corresponds to the start of the cycle. Here, the buffer is empty and the production rate is U_{max} ; the good parts produced are just starting to come out from the inspection station at a rate of $q(a)U_{max}$ toward the buffer, and “Flow 2” has not yet started. The safety buffer creation rate is then equal to $q(a)U_{max} - d$ and the buffer level, for this part is given by Eq. (6).

$$s(t) = Q(a(t)) - d.t \quad (6)$$

- Segment 2 begins with the start of “Flow 2” coming from rectification, and ends with the machine failure. The buffer is less than Z and the production rate is U_{max} ; the reworked parts start coming out from the rectification station at a rate of $p(a_{rect})U_{max}$ toward the buffer and join “Flow 1”. The safety buffer creation rate is then equal to $(q(a) + p(a_{rect}))U_{max} - d$ and the buffer level, for this part is given by Eq. (7).

$$s(t) = Q(a(t)) + (a(t - T_{rect}) - Q(a(t - T_{rect}))) - d.t \quad (7)$$

- Segment 5 starts with the failure of the machine (the machine was producing at rate U_{max}) and ends with the ending of “Flow 2”, the machine is down and the production rate is 0; Only “Flow 2”, from the rectification station feeds the buffer at a rate of $p(a_{rect})U_{max}$. The safety buffer creation rate is then equal to $p(a_{rect})U_{max} - d$ and the buffer level, for this part is given by Eq. (8).

$$s(t) = (a(t - T_{rect}) - Q(a(t - T_{rect}))) - d.t + \begin{cases} Q(A_f) & \text{if failure} \\ Q(M) & \text{otherwise} \end{cases} \quad (8)$$

- Segment 6 starts when all the ingoing flows stop and ends with the machine repair. Only the demand is decreasing the buffer. The safety

buffer creation rate is then equal to $-d$ and the buffer level, for this part is given by Eq. (9).

$$s(t) = \begin{cases} A_f - d.t & \text{if failure} \\ M - d.t & \text{otherwise} \end{cases} \quad (9)$$

Curves in Figs. 4a and 5a have six segments labeled from 1 to 6. Segments 1, 2 and 6 are the same as in Fig. 3a, except that buffers in Figs. 4a and 5a have reached the safety level, Z . Segment 5 is the same as in Fig. 3a, except that in Figs. 4a and 5a the machine was producing at rate d when the maintenance action starts (CM or PM). Segments 3 and 4 are as follows:

- Segment 3 starts when the machine switches its production rate to meet the demand and ends when the buffer is full. The production rate is adjusted to maintain the safety stock level. The ingoing flows 1 and 2 have rates $q(a)d$ and $p(a_{rect})U_{max}$, respectively. The safety buffer creation rate is then equal to $q(a)d + p(a_{rect})U_{max} - d$ and the buffer level, for this part is given by Eq. (10).

$$s(t) = Q(A) + (a(t - T_{rect}) - Q(a(t - T_{rect}))) - d.t \quad (10)$$

- Segment 4 starts when the buffer is full. The total ingoing rate is the same as the outgoing one. The safety buffer creation rate is then equal to zero and the buffer level for this segment is given by Eq. (11).

$$s(t) = Z \quad (11)$$

Eqs. (6) to (11) are the result of the integration of the buffer changing rate (Eq. (3)). Depending on system states, the buffer changing rate is different, and consequently the buffer level too (its integral) as shown in these equations.

Now that the dynamic of the buffer level is known, we could express the cumulative inventory in the final product stock and the total lost sales during a given cycle. The average inventory could be coined

directly from the integral of the surplus, $\int_{\text{cycle}} s^+(t) dt$ the area below the

curve $s(t)$ and above the axis time in Figs. 3, 4, and 5 (Eqs. (6) to (11)). This area is composed of four parts in Fig. 3b, labeled A1, A2, A5 and A6, and of six parts in Figs. 4b and 5b, labeled from A1 to A6. These areas are, respectively, the results of the integration of $s(t)$ expressions over a given cycle (Eqs. (12) to (17)).

$$A1 = \int_0^{T_{rect}} Q(a)dt - \frac{T_{rect}^2}{2}d \quad (12)$$

$$A2 = \begin{cases} \left(\frac{(T_f - T_{rect})^2}{2}U_{max} - \frac{(T_f^2 - T_{rect}^2)}{2}d \right) + \int_{T_f - T_{rect}}^{T_f} Q(a)dt - \int_0^{T_{rect}} Q(a)dt & \text{if } A_f \leq A \\ \left(\frac{(T_Z - T_{rect})^2}{2}U_{max} - \frac{(T_Z^2 - T_{rect}^2)}{2}d \right) + \int_{T_Z - T_{rect}}^{T_Z} Q(a)dt - \int_0^{T_{rect}} Q(a)dt & \text{otherwise} \end{cases} \quad (13)$$

$$A3 = \frac{T_z^2 - (T_z - T_{rect})^2}{2} U_{max} - \frac{(T_z + T_{rect})^2 - T_z^2}{2} d + \int_{T_z}^{T_z + T_{rect}} Q(a) dt - \int_{T_z - T_{rect}}^{T_z} Q(a) dt \quad (14)$$

$$A4 = \begin{cases} \left(T_f - \frac{A}{U_{max}} - T_{rect}\right)Z & \text{if } A_f \leq M \\ \left(T_M - \frac{A}{U_{max}} - T_{rect}\right)Z & \text{otherwise} \end{cases} \quad (15)$$

$$A5 = \begin{cases} \frac{T_f^2 - (T_f - T_{rect})^2}{2} U_{max} - \frac{(T_f + T_{rect})^2 - T_f^2}{2} d + T_{rect} Q(A_f) - \int_{T_f - T_{rect}}^{T_f} Q(a) dt & \text{if } A_f \leq A \\ T_{rect} Q(A_f) + T_{rect} Z - \int_{T_f}^{T_f + T_{rect}} Q(a) dt & \text{if } A \leq A_f \leq M \\ T_{rect} Q(M) + T_{rect} Z - \int_{T_M}^{T_M + T_{rect}} Q(a) dt & \text{otherwise} \end{cases} \quad (16)$$

$$A6 = \begin{cases} \left(\frac{A_f}{d} - T_f - T_{rect}\right)A_f - \frac{\left(\frac{A_f}{d}\right)^2 - (T_f + T_{rect})^2}{2} d & \text{if } A_f \leq M \\ \left(\frac{M}{d} - T_M - T_{rect}\right)M - \frac{\left(\frac{M}{d}\right)^2 - (T_M + T_{rect})^2}{2} d & \text{otherwise} \end{cases} \quad (17)$$

The lost sales represent the maximum shortage during the cycle, $\max_{\text{cycle}}^-(t)$, and could also be obtained from the value of $s(t)$ at the end of the cycle in the case where this value is negative, otherwise it is equal to zero. They correspond to the part labelled $L7$ in Figs. 3b, 4 b, and 5 b. Eq. (18) computes the lost sales value from Eq. (11).

$$L7 = \begin{cases} [dt_r - S_{max}]^+ & \text{if failure} \\ [dt_m - S_{max}]^+ & \text{otherwise} \end{cases} \quad (18)$$

Once the inventory components and lost sales value are known, we could compute KPIs and then express the total cost.

Assessment of system KPIs for the Case 1 where $A_f \leq A$

In this case, the failure occurs before the buffer is full ($S_{max} = \frac{A_f(U_{max}-d)}{U_{max}} \leq Z$) (Fig. 3).

The inventory level, the lost sales, and the cycle length, during this cycle, are given by Eqs. (19),(20), and (21), respectively.

$$WIP_1(A_f) = \int_{\text{Cycle}_1} s^+(t) dt = A1 + A2 + A5 + A6 = \frac{(U_{max} - d)A_f^2}{2 U_{max} d} - T_{rect}(A_f - Q(A_f)) \quad (19)$$

$$L_1(A_f, t_r) = L7 = \begin{cases} 0 & \text{if } t_r < \frac{A_f(U_{max} - d)}{U_{max} d} \\ dt_r - \frac{A_f(U_{max} - d)}{U_{max}} & \text{if } \frac{A_f(U_{max} - d)}{U_{max} d} \leq t_r \end{cases} \quad (20)$$

$$T_1(A_f, t_r) = \begin{cases} \frac{A_f}{d} & \text{if } t_r < \frac{A_f(U_{max} - d)}{U_{max} d} \\ t_r + \frac{A_f}{d} - \frac{A_f(U_{max} - d)}{U_{max} d} & \text{if } \frac{A_f(U_{max} - d)}{U_{max} d} \leq t_r \end{cases} \quad (21)$$

The system KPIs for the Case 2 where $A < A_f \leq M$

In this case, the failure occurs after the buffer is full ($S_{max} = Z$) and before the maintenance due age M (Fig. 4).

The inventory level, the lost sales, and the cycle length, during this cycle, are given by Eqs. (22),(23), and (24), respectively.

$$WIP_2(A_f) = \int_{\text{Cycle}_2} s^+(t) dt = A1 + A2 + A3 + A4 + A5 + A6 = \frac{(U_{max} - d)A^2}{2 U_{max}^2} + \frac{Z^2}{2d} + \frac{A_f - A}{d} Z - T_{rect}A + \frac{1}{d} \int_A^{A + dT_{rect}} Q(a) da + T_{rect}Q(A_f) - \frac{1}{d} \int_{A_f}^{A_f + dT_{rect}} Q(a) da \quad (22)$$

$$L_2(t_r) = L7 = \begin{cases} 0 & \text{if } t_r < \frac{Z}{d} \\ dt_r - Z & \text{if } \frac{Z}{d} \leq t_r \end{cases} \quad (23)$$

$$T_2(A_f, t_r) = \begin{cases} \frac{A_f}{d} & \text{if } t_r < \frac{Z}{d} \\ t_r - \frac{Z}{d} + \frac{A_f}{d} & \text{if } \frac{Z}{d} \leq t_r \end{cases} \quad (24)$$

The system KPIs for the Case 3 where $M \leq A_f$

In this case, no failure occurs before the maintenance due age. We stop the machine at age M to perform a preventive action and the buffer is full ($S_{max} = Z$) (Fig. 5).

The inventory level, the lost sales, and the cycle length, during this cycle, are given by Eqs. (25),(26), and (27), respectively.

$$WIP_3(A_f) = \int_{\text{Cycle}_3} s^+(t) dt = A1 + A2 + A3 + A4 + A5 + A6 = \frac{(U_{max} - d)A^2}{2 U_{max}^2} + \frac{Z^2}{2d} + \frac{M - A}{d} Z - T_{rect}A + \frac{1}{d} \int_A^{A + dT_{rect}} Q(a) da + T_{rect}Q(M) - \frac{1}{d} \int_M^{M + dT_{rect}} Q(a) da \quad (25)$$

$$L_1(t_m) = L7 = \begin{cases} 0 & \text{if } t_m < \frac{Z}{d} \\ dt_m - Z & \text{if } \frac{Z}{d} \leq t_m \end{cases} \quad (26)$$

$$T_3(t_m) = \begin{cases} \frac{M}{d} & \text{if } t_m < \frac{Z}{d} \\ t_m + \frac{M}{d} - \frac{Z}{d} & \text{if } \frac{Z}{d} \leq t_m \end{cases} \quad (27)$$

4.5.2. The total incurred cost

Now, we can compute the expected values of all KPIs: WIP, LOSS, and T in order to deduce the analytical expression of the total incurred cost.

To assess the expected value of any given KPI, we multiply the KPI value by its occurrence probability for each specific case defined in Figs. 3,4, and 5. For example, the average inventory value is assessed through equation: $WIP = \sum_{i=1}^3 \int (WIP_i) dF_{A_f, t_r, t_m}$, where F_{A_f, t_r, t_m} is the cumulative associated with the joint probability distribution of the age to failure, the corrective maintenance duration and the preventive maintenance duration.

The average inventory for final products, WIP, does not include the work in progress in the inspection and rectification stations. Its value is as follows:

$$\begin{aligned} WIP &= \int_0^A f_f(A_f) \left(\frac{(U_{max} - d) A_f^2}{2 U_{max} d} - T_{rect}(A_f - Q(A_f)) \right) dA_f \\ &+ \int_A^M f_f(A_f) \left(\frac{Z A_f}{d} + T_{rect} Q(A_f) - \frac{1}{d} \int_{A_f}^{A_f + dT_{rect}} Q(a) da \right) dA_f \\ &+ (F_f(M) - F_f(A)) \times \left(\frac{(U_{max} - d) A^2}{2 U_{max}^2} + \frac{Z^2}{2d} - \frac{Z A}{d} - T_{rect} A \right. \\ &\quad \left. + \frac{1}{d} \int_A^{A + dT_{rect}} Q(a) da \right) \\ &\quad + (1 - F_f(M)) \\ &\quad \times \left(\frac{(U_{max} - d) A^2}{2 U_{max}^2} + \frac{Z^2}{2d} + \frac{M - A}{d} Z + T_{rect} (Q(M) - A) \right. \\ &\quad \left. + \frac{1}{d} \int_A^{A + dT_{rect}} Q(a) da - \frac{1}{d} \int_M^{M + dT_{rect}} Q(a) da \right) \end{aligned} \quad (28)$$

The average lost sales is given by:

$$\begin{aligned} LOSS &= \int_0^A -f_f(A_f) \left(\frac{d M_1 r \left(\frac{(U_{max} - d) A_f}{U_{max} d} \right)}{\left(\frac{(U_{max} - d) A_f F_r \left(\frac{(U_{max} - d) A_f}{U_{max} d} \right)}{U_{max}} \right)} \right) dA_f \\ &- \left(d \left(MTTM - M_1 m \left(\frac{Z}{d} \right) \right) + Z \left(F_m \left(\frac{Z}{d} \right) - 1 \right) \right) (F_f(M) - 1) \\ &\quad + F_f(A) MTTR d \\ &- (F_f(A) - F_f(M)) \left(d \left(MTTR - M_1 r \left(\frac{Z}{d} \right) \right) \right. \\ &\quad \left. + Z \left(F_r \left(\frac{Z}{d} \right) - 1 \right) \right) \\ &\quad + \frac{(U_{max} - d)}{U_{max}} M_1 f(A) \end{aligned} \quad (29)$$

The average cycle length is:

$$\begin{aligned} T &= \int_0^A -f_f(A_f) \left(\frac{M_1 r \left(\frac{(U_{max} - d) A_f}{U_{max} d} \right)}{\left(\frac{(U_{max} - d) F_r \left(\frac{(U_{max} - d) A_f}{U_{max} d} \right) A_f}{U_{max} d} \right)} \right) dA_f \\ &+ (1 - F_f(M)) \left(MTTM - M_1 m \left(\frac{Z}{d} \right) + \frac{M}{d} - \frac{Z}{d} + \frac{Z F_m \left(\frac{Z}{d} \right)}{d} \right) \\ &\quad + \frac{M_1 f(A)}{U_{max}} \end{aligned} \quad (30)$$

$$\begin{aligned} &- (F_f(A) - F_f(M)) \left(MTTR - M_1 r \left(\frac{Z}{d} \right) - \frac{Z}{d} + \frac{Z F_r \left(\frac{Z}{d} \right)}{d} \right) \\ &\quad + F_f(A) MTTR - \frac{M_1 f(A) - M_1 f(M)}{d} \end{aligned}$$

The average values of the other KPIs:

- The respective average number of produced, good, and defective parts per cycle are:

$$TProd = M_1 f(M) - M (F_f(M) - 1) \quad (31)$$

$$TGProd = \int_0^M Q(a) f_f(a) da - Q(M) (F_f(M) - 1) \quad (32)$$

$$\begin{aligned} TBProd &= M_1 f(M) - M (F_f(M) - 1) - \int_0^M Q(a) f_f(a) da + Q(M) (F_f(M) \\ &- 1) \end{aligned} \quad (33)$$

- The average number of preventive and corrective maintenance per cycle are respectively:

$$NbPM = 1 - F_f(M) \quad (34)$$

$$NbCM = F_f(M) \quad (35)$$

- The average number of inspections done per cycle:

$$NbInsp = M_1 f(M) - M (F_f(M) - 1) \quad (36)$$

- The average number of rectifications done per cycle:

$$\begin{aligned} NbRect &= M_1 f(M) - M (F_f(M) - 1) - \int_0^M Q(a) f_f(a) da + Q(M) (F_f(M) \\ &- 1) \end{aligned} \quad (37)$$

- The average inventory per cycle in the inspection and rectifications shop:

$$\begin{aligned} InsRectWIP &= T_{rect} \left(M_1 f(M) - M (F_f(M) - 1) - \int_0^M Q(a) f_f(a) da \right. \\ &\quad \left. + Q(M) (F_f(M) - 1) \right) + T_{ins} (M_1 f(M) - M (F_f(M) - 1)) \end{aligned} \quad (38)$$

The total inventory in the system is composed of the final product inventory (*WIP*) and the inspection and rectification work in progress (*InsRectWIP*).

Based on the average values of these KPIs, the total incurred cost is given by:

$$Cost(Z, M) = \frac{C_h \cdot (WIP + InsRectWIP) + C_l \cdot LOSS}{T} + \frac{C_{pm} \cdot NbPM + C_{cm} \cdot NbCM}{T} + \frac{C_{insp} \cdot NbInsp + C_{rect} \cdot NbRect}{T} \quad (39)$$

4.6. The optimal strategy

The optimal strategy is defined by the buffer level Z^* and the maintenance threshold M^* on the usage of the machine. To find this optimal strategy, we solve the following optimization problem:

$$\text{Minimize } Cost(Z, M) \quad (40)$$

$$\text{Subject to : } \frac{U_{max}}{(U_{max} - d)} Z \leq M \quad (41)$$

$$(Z, M) \in (\mathbb{R}^+)^2 \quad (42)$$

The objective function $Cost(Z, M)$ is the total incurred cost given by Eq. (39). The first constraint is the link between the maintenance threshold and the buffer level. Because we allow the failures to occur during the safety stock building phase, the optimal maintenance threshold on the usage of the machine could be reached before the buffer is full and hence the maximum level of the buffer is $M(U_{max} - d)/U_{max}$. The second constraint is the type of the decision variables.

The strategy is to assess the optimality, as in

Fig. 9, through the computation of the gradient and the hessian matrix. We show, at the optimum, that the gradient is null and the hessian matrix is a positive definite matrix. We will then find the optimal safety-stock level Z^* , and age M^* , by computing numerically the gradient of the cost function and solving Eq. (43).

$$\overrightarrow{grad}(Z, M) = \begin{pmatrix} \frac{\partial Cost(Z, M)}{\partial Z} \\ \frac{\partial Cost(Z, M)}{\partial M} \end{pmatrix} = \vec{0} \quad (43)$$

To determine whether the optimum found in Eq. (43) is a minimum we computed numerically the hessian matrix (Eq. (44)) at (Z^*, M^*) and proved that the resulting matrix $Hess(Z^*, M^*)$ is a positive definite matrix by computing its eigenvalues and checking that they are all positive.

$$Hess(Z, M) = \begin{pmatrix} \frac{\partial^2 Cost(Z, M)}{\partial^2 Z} & \frac{\partial^2 Cost(Z, M)}{\partial Z \partial M} \\ \frac{\partial^2 Cost(Z, M)}{\partial M \partial Z} & \frac{\partial^2 Cost(Z, M)}{\partial^2 M} \end{pmatrix} \quad (44)$$

5. Simulation model and validation

To validate the proposed analytical model, we developed a simulation model for the same problem and compared its results to those obtained analytically. The optimal cost given by the analytical model should fall within the 95 % confidence interval obtained by simulation.

The simulation model was developed using a signal-based approach [1]. The model is an exact reproduction of the studied system dynamics.

5.1. Simulation new approach

Unlike classical simulation models in manufacturing, that use entity

based simulation, we used a different paradigm [1]. We model the system as signals that flows through different blocks, change their states and mimic the changes in the real system. It is a continuous model in which the signals represent the key characteristics of the modeled manufacturing system. These signals flow through blocks that compute the outputs and the states of the system and integrate its dynamics using the right solvers. This approach is the most suitable for a continuous simulation. Moreover, it allows precise results and faster run time, which helps to conduct many runs in a short period of time.

5.2. Simulation model

In this subsection, we will present the simulation model for the studied system. The routine for building a model under Simulink/Matlab consists in using pre-defined or user-created blocks and connectors to link them. Fig. 6 illustrates the simulation model. The system is composed of four blocks: the machine block, called "mach"; the buffer block; the inspection block and the rectification block.

In the first block, "mach", the machine broadcasts three signals. The first one shows the state of the machine (Up, Stopped for PM action, or Down under CM action); the second signal, represents the actual age of the machine; and the third one is a tag indicating whether or not a PM is performed. This block uses random signal generators to implement the desired distribution for the machine's lifespan, the PM repair duration, and the CM repair duration. The threshold M , the number of items produced before PM, indicates when the PM action is due. The signal rate feeds the machine block, which allows the block to compute the age of the machine through the usage.

The block "buffer" takes two feeds, the RateIn and RateOut signals, and uses an 'Integrator' to compute its state; there are also 'Relays' that detect the (discrete) states of the buffer and broadcasts them to the other blocks. The "inspection" block takes the production rate and the machine age signals, does the inspection with the right quality level, depending on the age, and then broadcasts two signals, one with good parts and the second with bad parts. The "rectification" phase uses the signal with bad parts, simulates the rework and then sends a signal with rectified parts. Finally, as shown in the main model, the rectified parts signal and the good parts signal feed the buffer block.

5.3. Validation

To insure the quality of the simulation model, assess its accuracy and make it realistic, we did not make any assumptions. The model is a mimic replication of the studied system. Fig. 7 is an example of plotted graphics that validate the simulation. This figure shows the machine state and age, the buffer level and the quality level changes during the simulation. The dynamics of Fig. 7, allow to analyze the evolution of the system performance indices, the results in this figure were obtained from a numerical instance when the control parameters are set to $Z = 27$, $M = 1200$.

A closed examination of Fig. 7 shows that the simulation model developed accurately represents the stochastic behavior of the production system under analysis, and that it ensures accurate results for our resolution approach.

6. Experiments and results

This section provides an illustrative example for the proposed analytical model. First, we will present the data used for the experiments, and then the results for the optimal solution, followed by a sensitivity analysis to show the impact of system parameters on the optimal solution. For all the results, including that of the sensitivity analysis, we performed a validation through the simulation at a 95 % confidence interval. All simulations were done over a sufficient time span to ensure a steady state. We simulated the system for 100,000 units of time (~20,000 cycles and 2,000,000 units of products) with 10

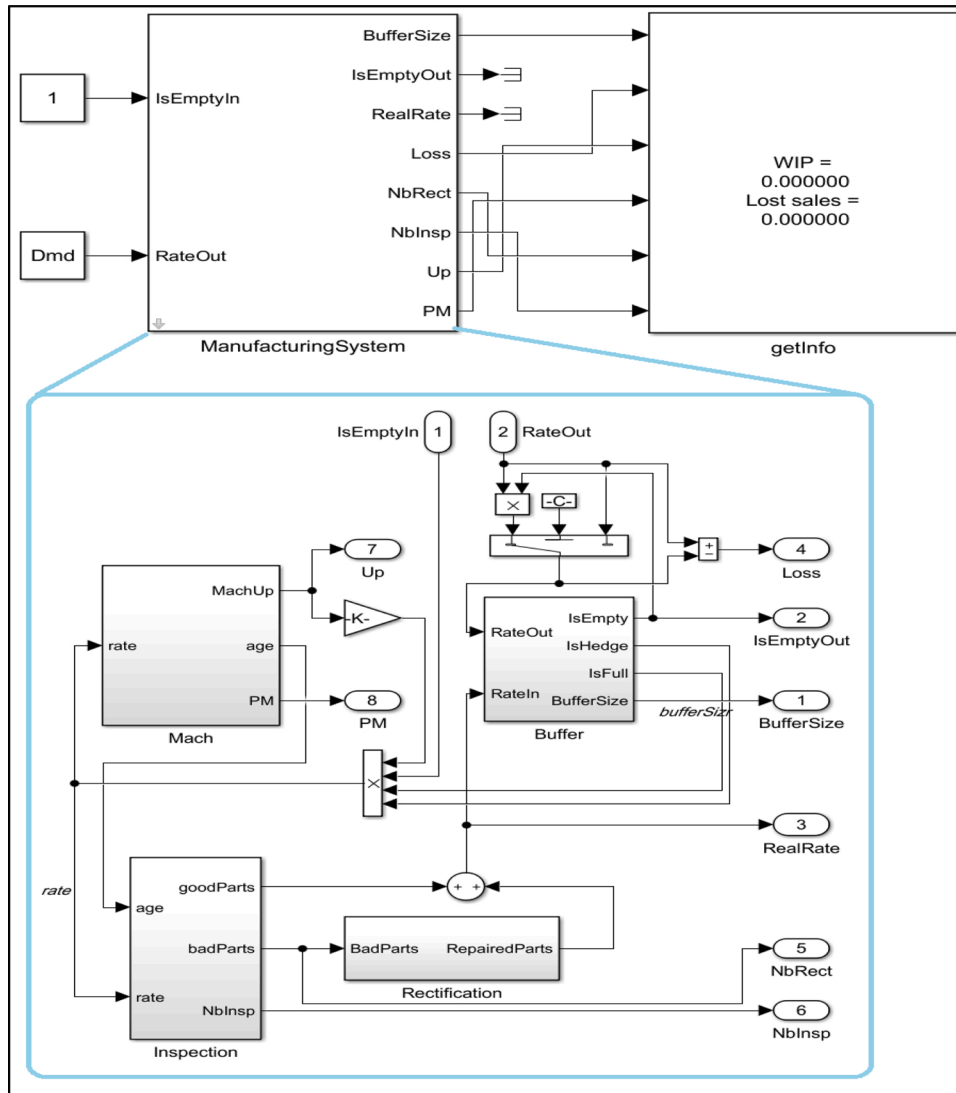

Fig. 6. Simulation model under Simulink.

replications. We then computed the 95 % confidence interval

6.1. The data

The following data describes the studied base case:

- The failure density function

$$f_f(a) = \lambda_f \cdot \gamma_f \cdot a^{(\gamma_f - 1)} \exp(-\lambda_f \cdot a^{\gamma_f}) \quad (45)$$

With: $\lambda_f = \left(\frac{\pi}{16}\right) \cdot 10^{-6}$ and $\gamma_f = 2.0$

The failure rate is increasing with the machine age.

We use a Weibull distribution because it is the most commonly used for modeling reliability data, is simple to interpret, and covers a whole family of systems. In fact, the degradation and the aging processes can be modeled by this law with only two parameters from historical data using techniques such as maximum likelihood [40].

The production quality, expressed in term of the defective proportion, depends on the age and is increasing with age. We used the following model to represent it :

$$p(a) = p_0 + \eta \cdot (1 - \exp(-\lambda_q \cdot a^{\gamma_q})) \quad (46)$$

With : $\lambda_q = \left(\frac{\pi}{2}\right) 10^{-7}$, $\gamma_q = 2.0$, $p_0 = 0.001$, and $\eta = 0.099$

With:

The preventive maintenance durations follow an exponential distribution with a mean: $MTTM = 1 TU$.

The correction maintenance durations follow an exponential distribution with a mean: $MTTR = 5 TU$.

The other operating parameters are:

U_{max}	d	T_{ins}	T_{rect}
30	20	1.10^{-2}	2.10^{-2}

The costs parameters are:

C_h	C_l	C_{pm}	C_{cm}	C_{ins}	C_{rect}
1	150	4000	8000	5	50

Based on these data, the manufacturing system has a capacity ($U_{max} = 30 products/TU$) that is 50 % above the market demand ($d = 20 products/TU$). The preventive maintenance and the corrective maintenance durations are, respectively, around 1% and 5% of the MTTF (MUTF=2000 products \Rightarrow MTTF=100 TU; MTTR=5 TU; MTTM=1 TU)

The defects proportion is chosen such that: (1) When the machine is new, the proportion is 0.1 %; (2) When the machine is somewhat aged,

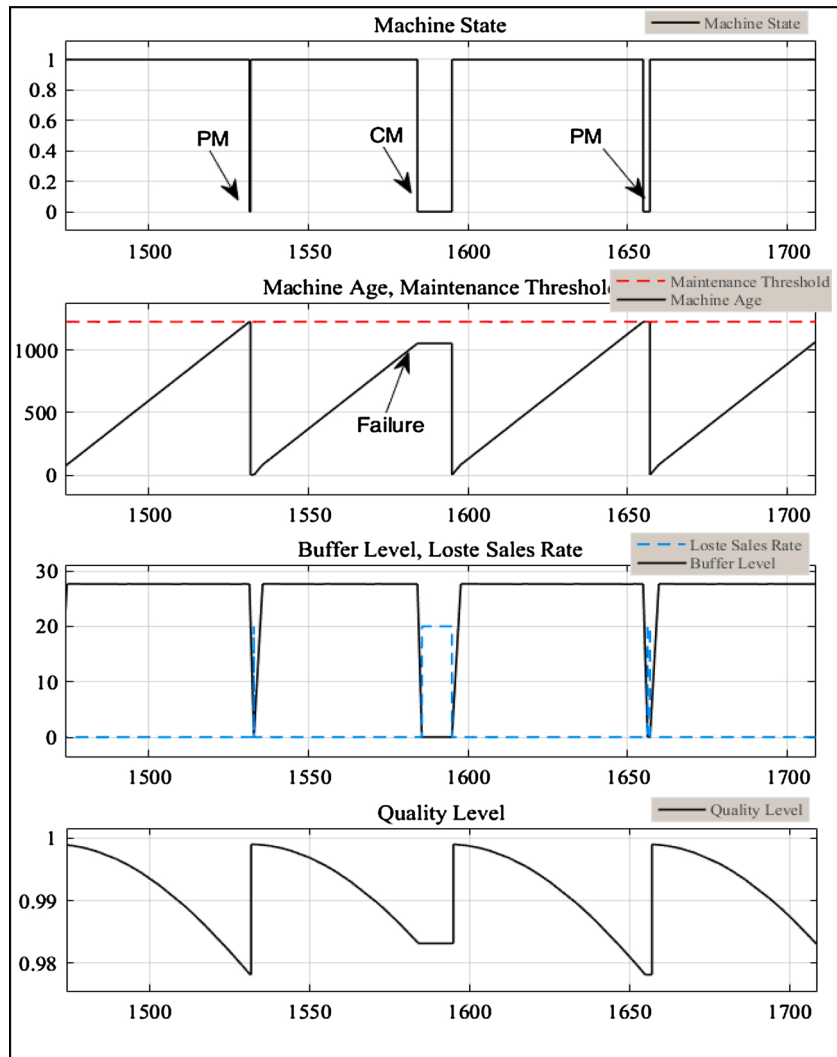

Fig. 7. Output graphics from the simulation: machine state and age, buffer level, lost sales and the quality level.

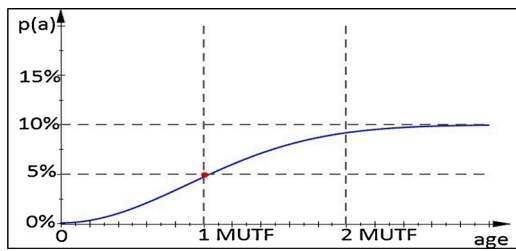

Fig. 8. Defect proportion evolution with machine age.

with a usage of $1 \times MUTF$, the proportion is around 5%; (3) and after a usage of about $2 \times MUTF$, the proportion drops drastically to the worst acceptable value, which is around 10%. Fig. 8 shows the evolution of the defect percentage with the age of the machine. The point in the middle of this figure shows that at the age of 100% of MUTF (when the machine produces around MUTF units), the percentage of defects is 5%. In this figure, we note the degradation of the system quality with the machine use.

6.2. The optimum

Fig. 9 shows the cost function surface around the optimum. The surface has a minima at (Z^*, M^*) . The surface is convex and has a unique

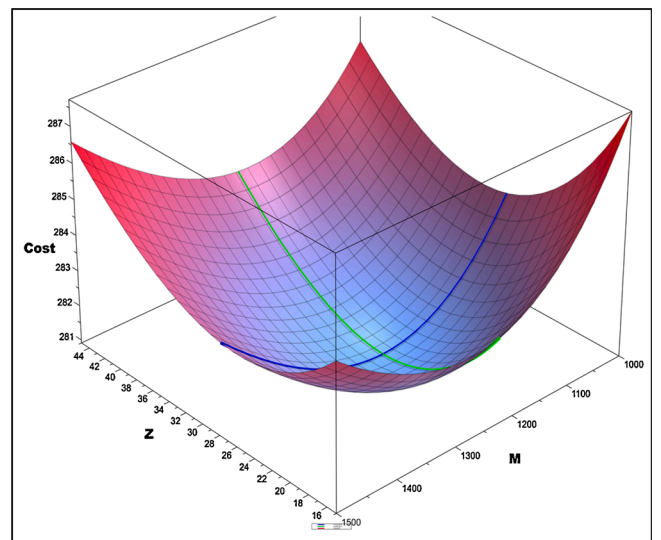

Fig. 9. Total incurred cost with variation of (Z,M).

Table 2

The optimal solution.

Optimal storage level: Z^*	27.642
Optimal maintenance Threshold: M^*	1226.08
Cycle length	56.9261
Average final goods storage	26.0745
Lost sales per unit of time	0.4058
Number of PM per unit of time	0.0131
number of CM per unit of time	0.0045
Number of Inspected units per unit of time	19.5942
Number of rectified units per unit of time	0.1515
Average work-in-progress in inspection	0.1959
Average work-in-progress in rectification	0.0030
Average availability	96.45%
Optimal total cost* per unit of time	280.9178
Confidence Interval at 95 % of the total cost	[276.7; 285.1]

minimum. To check the validity of the optimum solution, we compute, numerically, the gradient vector and the Hessian matrix of the cost function at (Z^*, M^*) , and we prove that it is a minimum.

Table 2 presents the basecase KPIs at the optimal point. It shows the optimal buffer level, the optimal maintenance threshold, the average cycle length, the average storage, the lost sales, the number of preventive and corrective maintenance actions, the inspection and the rectification frequencies, the work-in-progress in the inspection and rectification stations, the system availability, and the total incurred cost. The analytical results in this table are validated by simulation. The last line of Table 2 shows that the analytical optimal cost is within the confidence interval generated by the simulation model.

To check the validity of our optimum, we compute the gradient vector and the hessian matrix of the cost function and evaluate them at the optimum. The calculation of these derivatives is done numerically at the optimal point (27.642, 1226.08). Here is the value of the gradient vector; it is equal to the null vector:

$$\overrightarrow{\text{grad}}(Z^*, M^*) = \begin{pmatrix} -0.000033 \\ -0.000000 \end{pmatrix} \cong \vec{0}$$

This proves that (27.642, 1226.08) is an extreme point and to prove that it is a minimum, we compute numerically and evaluate the hessian matrix at (27.642, 1226.08) and prove that it is a positive definite matrix:

$$\text{Hess}(Z^*, M^*) = \begin{pmatrix} 0.0244695 & 0.0002195 \\ 0.0002195 & 0.0000897 \end{pmatrix}$$

Here are the eigenvalues of the hessian matrix at the optimal point. They are all positive:

$$\text{Eigenvalues}(\text{Hess}(Z^*, M^*)) = \begin{pmatrix} 0.0000877 \\ 0.0244715 \end{pmatrix}$$

6.3. The sensitivity analysis

A set of experiments was derived from the basic case by changing the system parameters in order to analyze the sensitivity of the optimal solution with respect to changes in these parameters. The objective behind the sensitivity analysis, beside demonstrating the quality of the proposed mathematical model and proving its effectiveness, was to investigate the effects of the system parameters on the optimal control settings and to study important aspects related to the interrelations between production, quality and maintenance control settings.

Table 3 presents 25 configurations of system parameters. The first one, "case 0", is the base case described above. The other 24 cases, from 1 to 24, are grouped by four cases. Each set, in order, presents the effects of the preventive maintenance cost (set I), the corrective maintenance cost (set II), the holding/lost sales cost (set III), the rectification cost (set IV), the availability/reliability of the system (set V) and the quality level (set VI), respectively, on the optimal strategy. All the cases were

validated by simulation at a 95 % confidence interval level.

Table 3 is organized as follows: Each line shows the results of each configuration. In the first two columns, we have the set and the case numbers, with case 0 representing the base case. The third and the fourth columns indicate what are the changes in the settings compared to the base case; for example, in case 1, columns three and four show that the corrective maintenance cost, C_{pm} , is decreased by 50 %. Columns 5–7 present the optimal solution found by the mathematical model for the case in question. In the eighth column, we have the simulation results presented as a 95 % confidence interval to assess the effectiveness of the mathematical model. The ninth column shows the availability of the system. The last three columns show the effect of the changes of the parameters on the optimal solution as a percentage of variations in Z^* , M^* and Cost*, as compared to the basic case.

The first observation is that all the optimal costs are within the respective 95 % confidence intervals generated by the simulation model. This proves the accuracy and the exactness of the proposed mathematical model.

Second, in cases 1–4 and 5–8, we have the reverse effects. In fact, when the preventive maintenance cost decreases or when the corrective maintenance cost increases, M^* decreases: Preventive actions are less costly or the failures are costly, so the system reacts by considering more preventive maintenance actions. In addition, to respond to this increase in maintenance cost, the system increases the safety stock Z^* . For case number 5, although the corrective maintenance cost is equal to the preventive one (see the data subsection), M^* is nonetheless not "Infinite". Traditionally, in such cases, works in the literature (which do not take quality degradation into account) suggest to not implement any preventive action. The proposed integrated model shows that preventive maintenance is needed even if it is more costly than the corrective one. Indeed, even when the corrective cost is equal to or less than the preventive cost, preventive actions are valuable for the system because they stop quality degradation due to machine age.

The third observation is for the cases 9–12, where the lost sales cost changes. The conclusion is the same as for the corrective maintenance: when the lost sales cost is higher, we need not only a higher safety stock, but also higher system reliability and a smaller M^* .

The fourth observation concerns the effect of the rectification cost, which is depicted in cases 13–16. When the rectification is costly, we need more safety stock, Z^* increases, and we need to produce more good parts than bad ones, and M^* decreases.

The fifth observation is for cases 17–20, when the system reliability changes and thus, unlike the other cases, we see big changes in availability. To change the reliability, we chose to change λ_f . In these cases, when λ_f decreases, M^* increases: the system is more reliable, and so we need fewer preventive actions. Moreover, Z^* decreases when λ_f decreases, and the safety stock is less because the system is more reliable. The safety stock is used in logistics to mitigate the effect of failures on the logistic flow. Therefore, when the occurrence of failures decreases, it is normal that the need for safety stock should decrease as well.

The sixth observation is about the quality impact. In cases 21–24, we change the inner quality of the system, from one that produces fewer defects to another that produces more defects. When the system is inclined to make more low-quality items, we need to decrease M^* and increase Z^* : we decrease M^* to reset its age more frequently and we increase Z^* to compensate for the deficiency in good parts due to a high percentage of defects.

6.4. Managerial insight and practical implementation

In this paper, we develop a realistic model to address the problem of the joint design of production and maintenance control policies. We aim to reduce the gap between research and practice by providing relevant and accurate policies that could be implemented in real world. Our approach helps the manager to answer the market demand while

Table 3
Sensitivity analysis results.

Set	Case	Parameter	Variation	Optimum Z^*	Optimum M^*	Total cost*	95 % Confidence Interval	Avail-ability	Variation vs. base case in %		
									Z^*	M^*	Cost*
	0	Basic	–	27.64	1226.08	280.92	[276.7; 285.1]	96.45 %	–	–	–
I	1	C_{pm}	– 50%	33.10	854.04	248.03	[244.2; 250.9]	96.29 %	19.7 %	–30.3%	–11.7%
	2	C_{pm}	– 25%	29.75	1048.77	266.38	[262.0; 267.8]	96.43 %	7.6 %	–14.5%	–5.2%
	3	C_{pm}	+ 25%	26.19	1397.44	292.79	[289.4; 296.8]	96.41 %	–5.3%	14.0 %	4.2 %
	4	C_{pm}	+ 50%	25.19	1569.42	302.61	[298.4; 305.3]	96.33 %	–8.9%	28.0 %	7.7 %
	5	C_{cm}	– 50%	26.61	1403.95	261.89	[259.1; 265.2]	96.40 %	–3.7%	14.51 %	–6.77%
II	6	C_{cm}	– 25%	27.11	1306.80	271.69	[267.5; 274.7]	96.43 %	–1.9%	6.58 %	–3.29%
	7	C_{cm}	+ 25%	28.19	1157.80	289.67	[284.5; 292.7]	96.45 %	2.0 %	–5.57%	3.11 %
	8	C_{cm}	+ 50%	28.73	1098.70	298.00	[292.7; 299.9]	96.44 %	4.0 %	–10.39%	6.08 %
	9	C_b	– 50%	0.00	1532.61	240.55	[237.5; 242.5]	96.40 %	–100.0%	25.00 %	–14.37%
III	10	C_b	– 25%	15.32	1346.65	263.73	[260.2; 267.0]	96.44 %	–44.6%	9.83 %	–6.12%
	11	C_b	+ 25%	37.58	1142.12	294.70	[289.9; 297.8]	96.44%	35.9 %	–6.85%	4.91 %
	12	C_b	+ 50%	46.08	1078.90	306.26	[300.0; 308.4]	96.42 %	66.7 %	–12.00%	9.02 %
IV	13	C_{rect}	– 50%	27.22	1283.20	277.00	[272.8; 281.0]	96.44 %	–1.5%	4.66 %	–1.39%
	14	C_{rect}	– 25%	27.43	1253.30	278.99	[275.2; 283.3]	96.44 %	–0.8%	2.22 %	–0.68%
	15	C_{rect}	+ 25%	27.85	1201.16	282.78	[278.2; 286.1]	96.45 %	0.8 %	–2.03%	0.66 %
	16	C_{rect}	+ 50%	28.05	1178.22	284.59	[280.3; 287.6]	96.45 %	1.5 %	–3.90%	1.31 %
V	17	λ_f	$\times 16/4$	71.55	688.49	402.17	[399.1; 413.0]	92.85 %	158.9 %	–43.85%	43.16 %
	18	λ_f	$\times 16/9$	40.04	960.13	323.58	[319.8; 330.1]	95.26 %	44.9 %	–21.69%	15.19 %
	19	λ_f	$\times 16/25$	20.95	1422.30	250.52	[248.7; 254.8]	97.15 %	–24.2%	16.00 %	–10.82%
	20	λ_f	$\times 16/36$	15.95	1650.50	234.60	[233.3; 238.0]	97.62 %	–42.3%	34.62 %	–16.49%
	21	η	$/4$	26.98	1316.54	275.67	[271.4; 279.3]	96.43 %	–2.4%	7.38 %	–1.87%
VI	22	η	$/2$	27.21	1283.30	277.49	[273.2; 281.4]	96.44 %	–1.6%	4.67 %	–1.22%
	23	η	$\times 2$	28.44	1137.20	287.09	[282.6; 289.5]	96.45 %	2.9 %	–7.25%	2.20 %
	24	η	$\times 4$	29.80	1016.79	297.55	[293.3; 298.8]	96.42 %	7.8 %	–17.07%	5.92 %

handling the state of the assets and the quality of the product. We provide answers to help tuning jointly the right production rate, inventory level and the preventive maintenance frequency to meet customer demand and to reduce the operating cost. In fact, joint controlling production rate, maintenance, and inventory reduces considerably the storage level and allows maintenance to improve not only the state of the machine but also the quality level by carrying out less rectification.

Fig. 10 presents a logic chart that guides the process of decision-making. At the beginning, when the machine is new, the manager should reset the counter to set the age of the machine to zero. Then he has to monitor the production rate, the machine state, the machine age and the inventory level. According to the optimal control parameters (Z^*, M^*), if the machine is “Down”, it should be repaired and the manager should reset the age counter. If no failure occurs during the production of 1226 (the PM threshold), the manufacturing system should be stopped and a PM action is carried out. Again, the manager should reset the age counter. During the manufacturing process, all parts are inspected and the defects are remanufactured. If the inventory level is less than 27.64 (the safety level), the manufacturing system should operate at maximum production rate (30 items/time unit). However, if the safety stock level is reached, the production rate is reduced to meet the demand rate (20 items/time unit).

7. Extension to the cases of imperfect preventive maintenance and inspection errors

In real world, maintenance and inspection are not always perfect. Many systems are never restored to the “as new” state after a PM actions and there are often errors in the inspection process. First, PM actions, only, help to rejuvenate the machine and extend its lifespan. In fact, depending on the complexity of the manufacturing system and the quality of the operators’ work, the state of the machine is, in general, between “As Good As New” (AGAN) and “As Bad As Old” (ABAO). The

maintenance could be imperfect due to many reasons like: hidden faults and failures which are not detected during maintenance; human errors such as wrong adjustments and further damage done during maintenance; replacement with faulty parts [33]. Second, the inspection process may misclassify items especially when the process is done manually and also when the workload is too high [46–48]; Two types of human errors may occur: Type I error (classifying a non-defective item as defective) and Type II error (classifying a defective item as non-defective).

To model the effect of the imperfect maintenance, we use so-called arithmetic reduction of age presented in Doyen and Gaudoin [21] and Rivera-Gomez et al. [41], where the PM actions reset the age of the machine to a value between AGAN and ABAO. The equation ($a^+(t) = \varphi \times a^-(t)$) illustrate the rejuvenation action of the preventive maintenance. The age of the machine before the PM actions is a^- , a^+ is the age after PM actions and $(1 - \varphi)$ denotes the efficiency of the PM actions that satisfies the condition: $0 \leq \varphi \leq 1$ (where $\varphi = 0$ correspond the AGAN case and $\varphi = 1$ to ABAO case). The value of φ is picked randomly and follow a given probability distribution that depends on the effectiveness of the maintenance action. Such distribution could be obtained from historical data. The machine is maintained after an age M , as explained before. But then again, as the maintenance is imperfect, the age of the machine after a PM action is not null and the value of Eqs. (11, 15,18) will be affected by the number of PM action done during a system cycle. This number follows a geometric distribution with parameter: $(F_f(M) - F_f(\varphi M)) / (1 - F_f(\varphi M))$. This parameter represents the probability of failure occurrence after a PM action and before the machine age reaches the PM threshold M . The optimization results are presented in Table 4. In this table we compare the result of the basic case (with perfect maintenance) and the cases with imperfect maintenance (cases 25 and 26). We notice that, at the optimum, the total cost increases and, as the maintenance is not perfect, the system tends to use less PM (M^* increases) and a higher safety stock level (Z^* increases) to reduce lost

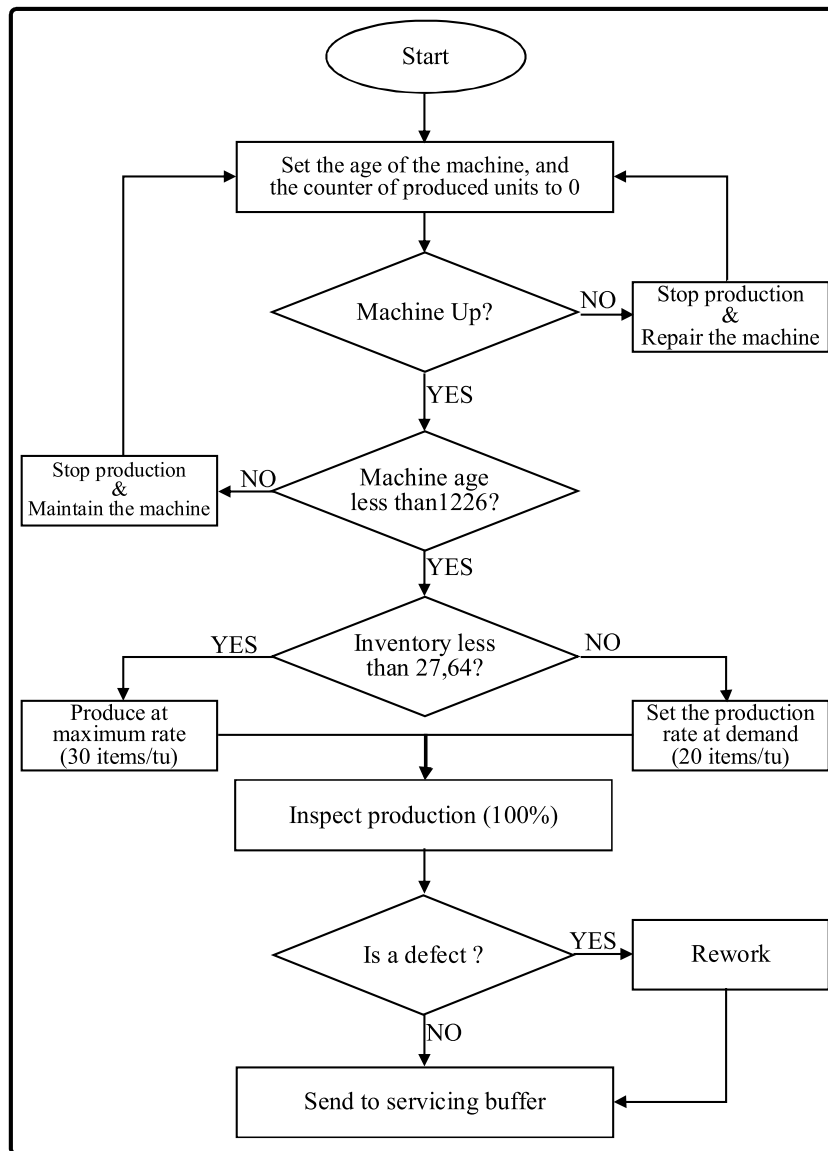

Fig. 10. Implementation logic chart of the proposed policy.

Table 4
Imperfect maintenance impact.

Case	$E(\varphi)$	Optimum Z^*	Optimum M^*	Total cost*
Basic	0%	27.64	1226.08	280.92
25	20 %	29.15	2795.00	367.33
26	40 %	30.37	3375.00	372.93

Table 5
Inspection errors (Type I & II) impact.

Case	$E(e_1)$	$E(e_2)$	Optimum Z^*	Optimum M^*	Total cost*
Basic	0%	0%	27.64	1226.08	280.92
27	3%	3%	27.79	1217.90	285.10
28	5%	5%	27.94	1212.07	287.84

sales). Indeed, when the maintenance efficiency decreases (the expected value of φ , $E(\varphi)$, increase) with the same cost of PM actions (C_{pm}) it is less important to do much PM.

For modeling the inspection errors (Type I and Type II), we use the formulation from Sett et al. [47]. We define e_1 as the probability of the Type I error and e_2 as the probability of Type II error. The two errors are randomly distributed. The effects on our model of these two errors are: we will end by reworking an extra $e_1 \times q(a)$ good items at the rectification station; and the customer will receive $e_2 \times p(a)$ bad items that we will have to replace which will increase the demand, the new demand is: $d/(1 - e_1 \times q(a))$. Thus, there will be two extra costs: one for the Type I error $Ce_1(e_1 \times q(a))$ and one for the Type II error $Ce_2(e_2 \times p(a))$ (where, Ce_1 and Ce_2 are the costs of misclassifying one item due to, respectively,

Type I and Type II errors). The optimization results are presented in Table 5. For the numerical result in this table we used as costs of the errors $Ce_1 = 5$ and $Ce_2 = 200$. We notice that, at the optimum, the total cost increases when the expected values of the errors, $E(e_1)$ and $E(e_2)$, increase. Also, when the errors level is higher (from case 27 to case 28), the system tends to plan more PM actions (M^* decreases). Indeed, with more PM actions, we reset the quality level, and thus, produce less defect and mitigate the impact of inspection error. As all defect are reworked and the bad parts received by customer are replaced, the effect on Z^* is minimal.

With a such extensions our model gets more closer to the reality and becomes more general. It could handle situations with perfect maintenance ($\varphi = 0$), with an imperfect maintenance ($\varphi \neq 0$), with perfect

inspection ($e_1 = e_2 = 0$), and with inspection errors (e_1 and/or $e_2 \neq 0$).

8. Conclusions

In the present paper, we deal with the problem of the joint design of production, maintenance, and inventory controls under quality and reliability degradation. We first propose an analytical model that allows relaxing many simplifying and unrealistic assumptions often used in the literature. Thereafter, we develop a signal-based simulation model and present a detailed sensitivity analysis in order to prove the exactness and the robustness of the proposed mathematical model.

The real-life features included in the proposed analytical model are: (1) no restriction on the type of probability distributions; (2) failures are allowed during the safety stock building phase; (3) inspection and rectification have non-negligible durations; and (4) both reliability and quality degradations are operation-dependent. The proposed analytical model has been validated by simulation, and can be easily implemented in practice. The results show that the analytical model is accurate and precise. Sensitivity analysis allows deriving relevant issues regarding interactions between production, inventory, maintenance, and quality control.

In this study, we, first, consider the case where the inspection process and maintenance are perfect. We, then, extend to the case with imperfect maintenance and inspections errors. Future extensions of this paper may integrate a quality control strategy. Statistical quality control techniques such as control charts and acceptance sampling plans are widely used in industry and help reducing the inspection time and the total quality control cost. Also, further research can be, also, conducted to extend this model to larger manufacturing systems with multiple products and multiple machines.

Declaration of Competing Interest

The authors declare that they have no known competing financial interests or personal relationships that could have appeared to influence the work reported in this paper.

Acknowledgements

This research has been supported by Natural Sciences and Engineering Research Council of Canada (NSERC) under grant number: RGPIN-2015-06026.

References

- [1] Ait El Cadi A, Gharbi A, Artiba A. MATLAB/SIMULINK-VS-ARENA/OPTQUEST: optimal production control of unreliable manufacturing systems. In: 11th International Conference on Modeling, Optimization and Simulation - MOSIM'16; 2016.
- [2] Akella R, Kumar PR. Optimal control of production rate in a failure-prone manufacturing system. *IEEE Trans Automatic Cont AC* 1986;31:116–26.
- [3] Assid M, Gharbi A, Hajji A. Production and setup control policy for unreliable hybrid manufacturing-remanufacturing systems. *J Manuf Syst* 2019;50:103–18. <https://doi.org/10.1016/j.jmsy.2018.12.004>.
- [4] Ben-Daya M, Duffuaa S. Maintenance and quality: the missing link. *J Qual Maint Eng* 1995;1(1):20–6.
- [5] Ben-Daya M, Makhdoum M. Integrated production and quality model under various preventive maintenance policies. *J Oper Res Soc* 1998;49:40–53.
- [6] Berthaut F, Gharbi A, Dhoubi K. Joint modified block replacement and production/inventory control policy for a failure-prone manufacturing cell. *Omega* 2011;39(6):642–54.
- [7] Berthaut F, Gharbi A, Kenné JP, Boulet JF. Improved joint preventive maintenance and hedging point policy. *Int J Prod Econ* 2010;127(1):60–72.
- [8] Boukas EK, Yang H. Optimal control of manufacturing flow and preventive maintenance. *IEEE Trans Automat Contr* 1996;41(6):881–5.
- [9] Bouslah B, Gharbi A, Pellerin R. Integrated production, sampling quality control and maintenance of deteriorating production systems with AOQL constraint. *Omega* 2016;61:110–26.
- [10] Bouslah B, Gharbi A, Pellerin R. Joint production, quality and maintenance control of a two-machine line subject to operation-dependent and quality-dependent failures. *Int J Prod Econ* 2018;195:210–26.

- [11] Buzacott J, Hanifin LE. Models of automatic transfer lines with inventory banks a review and comparison. *AIIE Transactions* 1978;10(2):197–207.
- [12] Chakraborty T, Giri B. Joint determination of optimal safety stocks and production policy for an imperfect production system. *Appl Math Model* 2012;36(2):712–22.
- [13] Chelbi A, Rezg N, Radhoui M. Simultaneous determination of production lot size and preventive maintenance schedule for unreliable production system. *J Qual Maint Eng* 2008;14(2):161–76.
- [14] Cheung KL, Hausman WH. Joint determination of preventive maintenance and safety stocks in an unreliable production environment. *Nav Res Logist* 1997;44(3):257–72.
- [15] Christer AH. Refined asymptotic costs for renewal reward processes. *J Oper Res Soc* 1978;29(6):577–83.
- [16] Colledani M, Tolio T. Joint design of quality and production control in manufacturing systems. *Cirp J Manuf Sci Technol* 2011;4(3):281–9.
- [17] Colledani M, Tolio T. Integrated quality, production logistics and maintenance analysis of multi-stage asynchronous manufacturing systems with degrading machines. *CIRP Ann Manuf Technol* 2012;61(1):455–8.
- [18] Dellagi S, Chelbi A, Trabelsi W. Joint integrated production-maintenance policy with production plan smoothing through production rate control. *J Manuf Syst* 2017;42:262–70.
- [19] Dhoubi K, Gharbi A, Ayed S. Availability and throughput of unreliable, unbuffered production lines with non-nhomogeneous deterministic processing times. *Int J Prod Res* 2008;46(20):5651–77.
- [20] Dohi T, Okamura H, Osaki S. Optimal control of preventive maintenance schedule and safety stocks in an unreliable manufacturing environment. *Int J Prod Econ* 2001;74(1):147–55.
- [21] Doyen L, Gaudoin O. Classes of imperfect repair models based on reduction of failure intensity or virtual age. *Reliab Eng Syst Saf* 2004;84(1):45–56.
- [22] El-Perik S. Economic production lot-sizing for an unreliable machine under imperfect age-based maintenance policy. *Eur J Oper Res* 2008;186(1):150–63.
- [23] Francie KA, Jean-Pierre K, Pierre D, Victor S, Vladimir P. Stochastic models and numerical solutions for manufacturing/remanufacturing systems with applications to the printer cartridge industry. *J Manuf Syst* 2015;37:662–71.
- [24] Giri B, Dohi T. Computational aspects of an extended EMQ model with variable production rate. *Comput Oper Res* 2005;32(12):3143–61.
- [25] Groeneveld H, Pintelon L, Seidmann A. Production batching with machine breakdowns and safety stocks. *Oper Res* 1992;40(5):959–71.
- [26] Gu P, Zhang X, Zeng Y, Ferguson B. Quality analysis and optimization of solid ground curing process. *J Manuf Syst* 2001;20(4):250–63.
- [27] Hadidi LA, Al-Turki UM, Rahim A. Integrated models in production planning and scheduling, maintenance and quality: a review. *Int J Ind Syst Eng* 2012;10(1):21–50.
- [28] Kenne J, Gharbi A. Experimental design in production and maintenance control problem of a single machine, single product manufacturing system. *Int J Prod Res* 1999;37(3):621–37.
- [29] Khouja M, Rabinowitz G, Mehrez A. Optimal robot operation and selection using quality and output trade-off. *Int J Adv Manuf Technol* 1995;10(5):342–55.
- [30] Matta A, Simone F. Analysis of two-machine lines with finite buffer, operation-dependent and time-dependent failure modes. *Int J Prod Res* 2016;54(6):1850–62.
- [31] Mourani I, Hennequin S, Xie X. Failure models and throughput rate of transfer lines. *Int J Prod Res* 2007;45(8):1835–59.
- [32] Okamura H, Dohi T, Osaki S. Computation algorithms of cost-effective EMQ policies with PM. In: Rahim M, Ben-Daya M, editors. *Integrated models in production planning, inventory, quality, and maintenance*. Boston: Kluwer Academic Publishers; 2001. p. 31–65.
- [33] Nakagawa T, Yasui K. Optimum policies for a system with imperfect maintenance. *IEEE Trans Reliab* 1987;36(5):631–3.
- [34] Ouaret S, Kenné JP, Gharbi A. Stochastic optimal control of random quality deteriorating hybrid Manufacturing/Remanufacturing systems. *J Manuf Syst* 2018;49:172–85. <https://doi.org/10.1016/j.jmsy.2018.10.002>.
- [35] Owen JH, Blumenfeld DE. Effects of operating speed on production quality and throughput. *Int J Prod Res* 2008;46(24):7039–56.
- [36] Pan E, Jin Y, Wang S, Cang T. An integrated EPQ model based on a control chart for an imperfect production process. *Int J Prod Res* 2012;50(23):6999–7011.
- [37] Polotski V, Kenné JP, Gharbi A. Optimal production scheduling for hybrid manufacturing-remanufacturing systems with setups. *J Manuf Syst* 2015;37(Part.3):703–14. <https://doi.org/10.1016/j.jmsy.2015.02.001>.
- [38] Radhoui M, Rezg N, Chelbi A. Integrated maintenance and control policy based on quality control. *Comput Ind Eng* 2010;58(3):443–51.
- [39] Rezg N, Dellagi S, Chelbi A. Joint optimal inventory control and preventive maintenance policy. *Int J Prod Res* 2008;46(19):5349–65.
- [40] Rinne H. *The Weibull distribution: a handbook*. Boca Raton, FL: CRC Press; 2008.
- [41] Rivera-Gomez H, Gharbi A, Kenné JP. Joint control of production, overhaul, and preventive maintenance for a production system subject to quality and reliability deteriorations. *Int J Adv Manuf Technol* 2013;69(9–12):2111–30.
- [42] Rivera-Gómez H, Gharbi A, Kenné JP, Montaña-Arango O, Hernández-Gress ES. Subcontracting strategies with production and maintenance policies for a manufacturing system subject to progressive deterioration. *Int J Prod Econ* 2018;200:103–18.
- [43] Rivera-Gómez H, Montaña-Arango O, Corona-Armenta JR, Garnica-González J, Ortega-Reyes AO, et al. JIT production strategy and maintenance for quality deteriorating systems. *Appl Sci* 2019;9(6):1180.
- [44] Sarkar B. Mathematical and analytical approach for the management of defective items in a multi-stage production system. *J Clean Prod* 2019;218:896–919.
- [45] Sarkar B, Sana SS, Chaudhuri K. Optimal reliability, production lot size and safety stock in an imperfect production system. *Int J Math Oper Res* 2010;2(4):467–90.

- [46] Sarkar B, Sett BK, Sarkar S. Optimal production run time and inspection errors in an imperfect production system with warranty. *J Ind Manag Optim* 2018;14(1): 267.
- [47] Sett BK, Sarkar S, Sarkar B. Optimal buffer inventory and inspection errors in an imperfect production system with preventive maintenance. *Int J Adv Manuf Technol* 2017;90(1-4):545-60.
- [48] Tiwari S, Kazemi N, Modak NM, Cárdenas-Barrón LE, Sarkar S. The effect of human errors on an integrated stochastic supply chain model with setup cost reduction and backorder price discount. *Int J Prod Econ* 2020:107643.
- [49] Xiao S, Chen Z, Sarker BR. Integrated maintenance and production decision for k-out-of-n system equipment with attenuation of product quality. *Int J Qual Reliab Manag* 2019.