



HAL
open science

Adaptation of LTE-Downlink Physical Layer to V2X and T2X communications

Bouna Fall, Smail Niar, Atika Rivenq

► **To cite this version:**

Bouna Fall, Smail Niar, Atika Rivenq. Adaptation of LTE-Downlink Physical Layer to V2X and T2X communications. *International Journal of Innovative Technology and Exploring Engineering*, 2015, 4 (10), pp.182-192. hal-03401206

HAL Id: hal-03401206

<https://uphf.hal.science/hal-03401206v1>

Submitted on 25 Nov 2024

HAL is a multi-disciplinary open access archive for the deposit and dissemination of scientific research documents, whether they are published or not. The documents may come from teaching and research institutions in France or abroad, or from public or private research centers.

L'archive ouverte pluridisciplinaire **HAL**, est destinée au dépôt et à la diffusion de documents scientifiques de niveau recherche, publiés ou non, émanant des établissements d'enseignement et de recherche français ou étrangers, des laboratoires publics ou privés.

Adaptation of LTE-Downlink Physical Layer to V2X and T2X communications

B. FALL, S. NIAR, A. SASSI, A. RIVENQ
University Of Valenciennes (UVHC)

Abstract— In the field of transport, including land, some challenges to be faced. Ensuring passenger's safety and security, overcoming Increasing traffic during their journey and providing real time multimedia information are examples of new interesting services for the end user. Long Term Evolution technology turns out to be very promising for addressing these challenges. In this paper, the feasibility of adapting the LTE-Downlink Physical Layer (LTE-PLD) is studied for Vehicle-to-Vehicle and Vehicle to Infrastructure (named V2X) and for Train to Train or Train to Infrastructure (named T2X) communications. The ultimate goal being to propose a complete system based into LTE technology for information exchange (V2X, T2X) high throughput in an environment of very high mobility. In this original approach, the performances are evaluated in terms of BER vs. SNR, PER vs. SNR and we take into account the propagation channel suitable for high speeds named the WINNER II channel Model. The model is refined and validated using measurements made within the WP1 channel Model work package in Europe and readapted in MATLAB/SIMULINK. The results obtained show that, in this case study, LTE is a potential good candidate for V2X and T2X communications.

I. INTRODUCTION

In recent years, operators and users of guided transport systems have expressed a strong demand to provide safe and efficient transport, providing an increasing quality of service. Among all the technical requirements which are consequently generated, it is essential to ensure an adequate exchange of information between vehicles and infrastructure, regardless of the type of application or the propagation environment [1]. For V2X communications, the IEEE 802.11p is used for Dedicated Short - Range Communications (DSRC) in the domain of ITS, and will provide safety and infotainment applications such as collision avoidance, traffic management avoidance, information downloading, commercial applications and others [2]. However, studies in [3] and [4] show that the performance of this technology is extremely sensitive to larger vehicle densified, traffic load, and vehicle speed. Moreover, most of the 802.11p's disadvantages are caused by its ad hoc nature and they are well known problems that all ad hoc networks face. To overcome these few unresolved issues with its performance, it is necessary to propose an alternative communication protocol which could either assist

or replace the IEEE 802.11p. LTE radio technology (Long Term Evolution) is the new standard radio communication at very high speed, which offers interesting prospects and could be an alternative for V2X communication [5].

For T2X communications, applications needed are widely dedicated to guided transport. For this area, the most widely used communication system between trains and the elements involved in operation, control, and intercommunication of the railway infrastructure is based on adapting the Global System for Mobile Communications (GSM) technology, namely GSM for Railways (GSM-R). The GSM-R characteristics and capabilities do not match requirements of advanced railway services such as automatic pilot applications or provisioning broadband services to the train staff and passengers. Moreover, maintenance costs are increasing because GSM-R devices are ad-hoc solutions based on legacy technology. Moreover, another major problem with GSM-R is its very limited support for data communication and its insufficient capacity, i.e. a small number of channels available for user transmission. This is a consequence of the combined effect of the circuit switched transmission paradigm and the reduced band of radio spectrum assigned. In areas with high train concentration, such as central train stations, there are problems with providing sufficient number of channels to serve all the trains operating simultaneously [6]. Existing solutions are impractical, prone to error and cannot solve the capacity problem entirely. With LTE, it would be possible to share a single radio communication channel for different services. Real-time video surveillance, information geolocated traveler, high speed Internet ... LTE turns out be an interesting successor of cellular networks, but also TETRA, GSM-R and CBTC [6].

Thus, it is interesting to evaluate LTE performances for communications in transport systems taking into account, among the speed of displacement vehicles or trains and propagation channels. and, especially as there is no works or research in this area.

In this paper, the performance of LTE applied to V2X and T2X communications is studied using Physical Layer Downlink Model based on Matlab/Simulink. Two types of channel propagation model are used: the WINNER II Channel Model [7] supplying multipath fading channel suitable for high speed railway in Europe and the frequency-selective high mobility which is included in the

block simulink channels. BER (Bit Error Rate) vs. SNR (Signal to Noise Ratio) in one side and PER (Packet Error Rate) vs. SNR in the other side are studied using different degrees of MIMO antenna correlation, different type of modulation such as QPSK, 16QAM and 64QAM and different types of velocity. Performances are evaluated both for V2X and T2X communication. This paper is organized as follows. Section II describes LTE technology and its interest in transportation systems. Section III presents the system description including the LTE Physical Layer Downlink (LTE-PLD) model based on Matlab/Simulink to study the LTE technology in context of V2X and T2X communication. Section IV presents BER and PER measurements, simulation results and interpretations. Finally, conclusions and perspectives are provided in section V.

II. LTE TECHNOLOGY FOR TRANSPORTATION

A. LTE Architecture

LTE (Long Term Evolution) is the 4G wireless technology standardized in 2008 by the 3GPP. This technology provides flexibility of deployment and it is open, secure, reliable and easy to operate. LTE is composed of a core network: Evolved Packet Core (EPC) and an access radio network UMTS Terrestrial Radio Access Network (E-UTRAN) [8]. EPC is a native « all IP » based and multi-access network that enables the deployment and operation of a common network for every kind of 3GPP access network (2G, 3G and LTE), and even 3GPP (WLAN). E-UTRAN LTE is connected to the EPC core network in packet mode. Protocols and user plans have been designed in order to support high bandwidth applications together with real-time constraints, Quality of Service (QoS) and high availability. Fig. 1 presents the LTE architecture, its main components are:

- E-UTRAN composed of eNodeB (LTE base stations)
- EPC is composed of:
 - Service gateway (SGW)
 - Packet Gateway (PGW)
 - Mobility manager (MME)
 - Policy and Charging Rules Function (PCRF)
 - Home Subscriber Server (HSS)
 - IP Multimedia Subsystem (IMS)

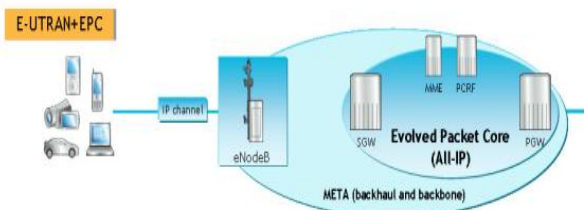

Fig. 1. LTE Architecture

B. LTE for V2X and T2X communication

LTE seems more cost effective to deploy infrastructure for vehicle services. It is possible to reduce the latency between 1-10 milliseconds required for real-time applications [9]. To

reduce costs, the use of LTE radio networks modified with some additional intelligence would be much more profitable. It has been envisioned to exploit the very existing LTE infrastructure to support vehicular networking applications either through an advanced LTE-enabled OBU or using smartphones with LTE connectivity. In term of mobility, E-UTRAN shall support mobility across the cellular network and should be optimized for low mobile speed from 0 to 15 km/h. Higher mobile speed between 15 and 120 km/h should be supported with high performance. Mobility across the cellular network shall be maintained at speeds from 120 km/h to 350 km/h, or even up to 500 km/h (for high speed trains) depending on the frequency band [10]. Many other reasons have qualified LTE as a possible candidate for use in ITS networks such as: its extraordinary performance (in terms of high data rate, time of latency...), ease of deployment, its infrastructure based technology... etc.

In the field of guided transport, such as in train, metro, we see an increasing need for high speed communications from the world of transport for ever more innovative services:

- For operators: data exchange / ground;
- For passengers: online services, such as passenger information in real time and internet services.

Thanks to its high bandwidth, LTE could provide those services. Indeed, LTE performance today offers higher achievable theoretical speeds of 100 Mbps, which is 10 000 times faster than current low-throughput technologies, TETRA and GSM-R. The deployment of an LTE network in the guided transport such as underground metro could allow several services for the end-user: Telephony and Mobile Internet in the subway, Passenger information, Multi-modal applications...etc. [11]. Fig. 2 illustrates the operation of LTE in transport (V2I and T2I communication).

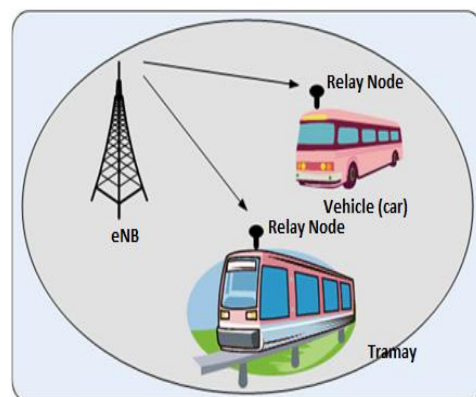

Fig. 2. LTE for transport (case of V2I and T2I communication)

Use of this LTE technology for transportation, including the V2X and T2X communications necessitates to adapt it in high mobility environment and to study its performance. For this goal, this study adapts the LTE physical layer downlink model to the context of V2X and T2X communication in order to evaluate the performance. When you submit your final version, after your paper has been accepted, prepare it in two-column format, including figures and tables.

III. SYSTEM DESCRIPTION

A. LTE – PLD Model

The core of the LTE down link radio transmission is the Orthogonal Frequency Division Multiplexing (OFDM) with data being transmitted on a large number of parallel narrow band subcarriers. This is an attractive property as it simplifies the receiver base band processing with a reduced terminal cost and power consumption as consequences.

This LTE-PLD is implemented using both Simulink blocks and MATLAB System objects from the Communications System Toolbox and the LTE system toolbox. It is based on the Downlink Shared Channel (eNodeB to UE) specifications developed by the Third Generation Partnership Project (3GPP) [12, 13]. Theoretically, the best way to increase data rates over a communications link is to increase the overall received signal power for a given transmit power. An effective way of increasing the received power is to use additional antennas at the transmitter and/or the receiver. For this, the LTE-PLD model uses multiple antennas at both transmitter and

receiver based on modes of 2-by-2 antenna configurations named MIMO 2x2. The model employs a multi-codeword spatial multiplexed transmission using closed-loop codebook-based pre-coding. Fig. 3 shows the model compound of the transmission part, the channel propagation part and the reception part and data processing. Each part is described below.

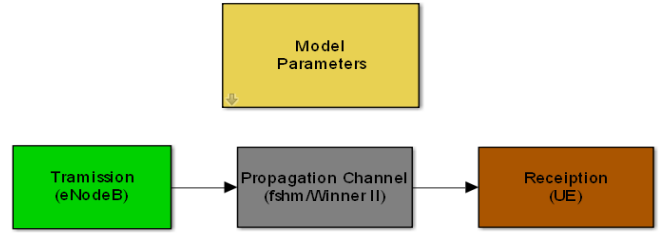

Fig. 3. LTE-PLD Model

A.1. The Transmission Part

The transmission part is shown in Fig. 4. Its components include:

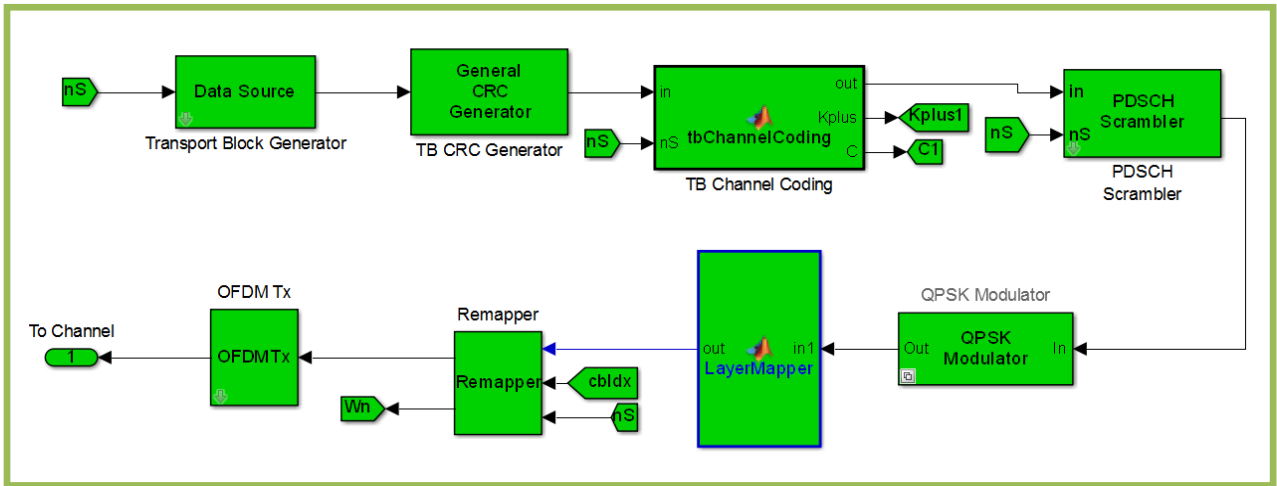

Fig. 4. LTE-Transmission Part

Transport Channel Processing: Transport channels provide the interface between the MAC layer and the physical layer. The Downlink Shared Channel (DL-SCH) is the main downlink transport channel type in LTE. It is used for both user data and dedicated control information as well as part of downlink system information.

CRC insertion per transport block: The model calculates and appends a 24-bit CRC to each generated transport block. This allows for detection of errors at the receive end for the decoded block.

Code-block segmentation and per code-block CRC insertion: Due to the turbo-coding inter-leaver block lengths supported by LTE (a maximum of 6144 bits), any transport block that exceeds this size is segmented into smaller code-blocks. Based on the link parameters configured and the transport block size determined. No filler bits are

necessary as part of the segmentation process. For multiple code-blocks per transport block, the model calculates and appends a 24-bit CRC to each code block. This allows for early detection of correctly decoded code blocks, and, as a result, early termination of the iterative decoding for that code block.

Channel coding: DL-SCH uses turbo coding as the channel coder. The Parallel Concatenated Convolutional Coding:

Rate Matching: Rate matching extracts the exact set of bits to be transmitted within a sub-frame from the encoded bits. This example implements the sub-block interleaving, creation of the circular buffer and the actual bit selection using UE Category 5 parameters. The multiple code-blocks are then concatenated together for downstream physical channel processing.

Physical Channel (PDSCH) Processing: A physical channel corresponds to a set of time-frequency resources used for transmission of a particular transport channel. Each transport channel maps to a corresponding physical channel. The Physical Downlink Shared Channel (PDSCH) is the main physical channel used for unicast data transmission.

Scrambling: The transport channel encoded bits are scrambled by a bit-level scrambling sequence. The scrambling sequence depends on the physical layer cell identity to ensure interference randomization between cells. For the single-user single cell downlink transmission, the example assumes a cell ID, but differentiates the sequence per transmitted codeword.

Data Modulation: Downlink data modulation converts the scrambled bits into complex modulated symbols. The set of modulation schemes supported include QPSK, 16QAM and 64QAM, corresponding to two, four, and six bits per modulation symbol respectively. The modulation scheme is chosen by the PDSCH modulation type parameter on the Model Parameters block that including in the LTE-PLD model.

Layer Mapping: The complex modulated symbols from both codeword are mapped to layers. Since full rank transmission is assumed, the number of layers is equal to the number of transmit antennas (the latter determined from the Antenna configuration parameter on the Model Parameters block).

Resource Element Mapping: The pre-coded symbols to be transmitted on each antenna are mapped to the resource elements of the resource blocks available for transmission. The number of available resource blocks depends on the channel bandwidth parameter on the model parameter block. Table 1 illustrates the relationship between the channel bandwidth and the number of resource blocks transmitted over an LTE RF carrier. For the study presented in this paper, we use 10 MHz of channel bandwidth and it corresponds to 50 resource blocks.

TABLE 1. Channel Bandwidth versus Numbers of Resource Blocks

Channel Bandwidth [Mhz]	1.4	3	5	10	15	20
Number of Ressource blocks	6	15	25	50	75	100

For the chosen configuration, each resource block corresponds to 12 sub-carriers, which spacing of 15 KHz, and then 180 KHz was chosen as the resource block bandwidth.

In the time domain, LTE organizes the transmission as a sequence of radio frames of 10 ms length. Each frame is then subdivided into 10 sub-frames of length 1ms. Each sub-frame

is composed of two slots of length 0.5 ms each [15]. Finally, each slot consists of a number of OFDM symbols, either seven or six depending on whether a normal or an extended cyclic prefix is used. Fig 5 illustrates the time structure used in the LTE-PLD Model.

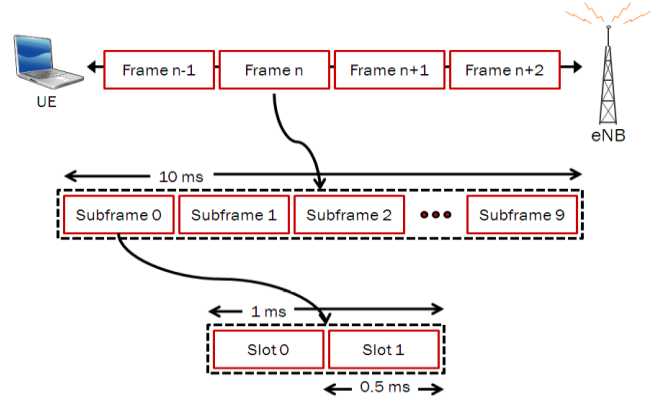

Fig. 5. LTE time-domaine structure

OFDM Transmission: OFDM is used in LTE Downlink by virtue of simple implementation in receiver and high performance. In OFDM, Frequency selective wide band channel is divided into non-frequency selective narrowband sub-channels that are orthogonal to each other [16]. Each subcarrier is modulated based on QPSK, 16QAM and 64 QAM. Table 2 presents OFDM parameters used in LTE-PLD model. The complex-valued time-domain OFDM signal per antenna is generated from the fully populated resource grid. The number of FFT points depends on the channel bandwidth specified.

TABLE 2. OFDM Parameters in LTE – PLD Model

Bandwidth (Mhz)	1.4	3	5	10	15	20
Sampling Frequency (Mhz)	1.92	3.84	7.68	15.36	23.04	30.72
FFT size	128	256	512	1024	1536	2048
Number of resource blocks	6	15	25	50	75	100
OFDM symbol per slot	14/12 (Normal/Extended)					
CP length	4.7/5.6 (Normal/Extended)					

A.2. Channel Propagation Models

Since we are in high or very high speed settings (50 to 500 km/h), we used two channel models to account for propagation conditions including the Doppler Effect. One based on MIMO channel model (Frequency Selective High Mobility) and the other based on the Winner II Channel Model. Each of these models is described in this subsection.

A.2.1. MIMO Channel Model (Frequency Selective High Mobility Channel)

MIMO channels specify the relationships between signals transmitted over multiple transmit antennas and signals received at multiple receive antennas. The number of connection links is equal to the product of the number of transmit antennas and the number of receive antennas [16]. The frequency-selective high-mobility block is modeled taking into account three parameters: the number of path delays, the channel path gain which is the relationship between any given pair of transmit and receive antennas at any point in time it is a scalar gain value, and the Doppler effects which characterizes mobility with speeds ranging from 50 to 500 km/h depending on the communication context (V2X or T2X). Use either SI (MKS) or CGS as primary units. (SI units are strongly encouraged.) English units may be used as secondary units (in parentheses).

A.2.2. The Winner II Channel Model

The WINNER II channel model is a geometry-based stochastic model which can describe arbitrary number of propagation environment realizations for single or multiple radio links for all the defined scenarios for desired antenna configurations, with one mathematical framework by different parameter sets. Generic model is a stochastic model with two (or three) levels of randomness. At first, large scale (LS) parameters like shadow fading, delay and angular spreads are drawn randomly from tabulated distribution functions. Next, the small-scale parameters like delays, powers and directions [17]. Arrival and departure are drawn randomly according to tabulated distribution functions and random LS parameters (second moments). It also called a double directional channel model. The model does not explicitly specify the locations of the scatters, but rather the directions of the rays, like the well-known Spatial Channel Model (SCM). Both IMT-advances and consequently, LTE Advanced, apply this kind of model as the MIMO channel model for performance tests.

The WINNER Channel Modeling is divided into three phases: definition of propagation scenarios, defining of data analysis and the items required in simulation. The first phase means selection of environments to be measured, antenna heights, mobility, and other general requirements. Generic model is needed to know what parameters have to be measured. For this, to explore the WINNER II channel model in Simulink, we use the open sourced matlab code available in winner website to implement block named WIN2 in simulink. Table 3 presents supported propagation scenarios limited in C2 and D2 scenario that we use in our studies (C2 used for V2X communication and D2 (extended to velocity=500 Km/h) for T2X communication) [7]. In the case of our study, each channel model is combined with a Gaussian type channel (AWGN) using AWGN simulink

block.

TABLE 3. Supported Propagation Scenario in WINNER II Channel Model

Scenario	Definition	LOS /NLOS	Mob. Km/h	Frequency [GHz]
C2 Metropol	Typical urban macro-cell	NLOS	0 – 120	2 - 6
D2	a) Moving networks: BS – MRS, rural	LOS	0 – 350 (extended to 500 km/h)	2 - 6

A.3. Channel Propagation Models

Several Elements of the reception part are made of inverse operation of the transmission part as shown in Fig 6. We note include:

OFDM receiver: undoes the unequal cyclic prefix (CP) lengths per OFDM symbol in a slot and converts back to the time- and frequency-domain grid structure. The CP is removed and an FFT operation is performed to recover the received data and reference signals at each subcarrier.

MIMO receiver: it inverts the combination of pre-coding and MIMO channel operations to recover the best estimate of the modulated symbols. It includes:

- **Channel Estimation:** is performed by examining known reference symbols, also referred to as pilots, inserted at regular intervals within the OFDM time–frequency grid. Using known reference symbols, the receiver can estimate the channel response at the subcarriers where the reference symbols were transmitted.
- **Codebook selection:** employs the minimum-mean-squared-error (MMSE) criterion to calculate the codebook index per sub-frame. When the Enable PMI Feedback parameter is on, this index is feedback to the transmitter for use at the next time step. Otherwise, the user-specified codebook index is used for the duration of the simulation. The feedback granularity modeled is once for the whole sub-frame (wideband) and applied to the next transmission sub-frame.

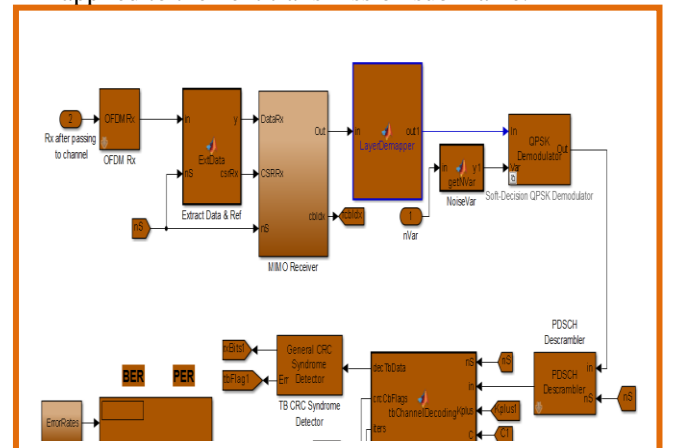

Fig. 6. LTE-Receiver Part

IV. PERFORMANCES EVALUATIONS

In this section, the performances of the LTE-PLD Model are evaluated in the context of V2X and T2X communication. To do this, the BER (Bit Error Rate) and PER (Packet Error Rate) are measured versus the SNR (Signal to Noise Ratio) using MIMO correlation in different configurations, different mobile velocities, different modulations and different channel model.

A. MIMO Correlation

Three levels of spatial correlations are considered, Low Correlation, Medium Correlation and High Correlation. To assess the impact of the level of correlation on the performance of LTE-PLD system, we evaluated the BER and PER based on with these three levels fixing modulation to 16QAM and velocity to 90Km/h in case of V2X Communication and 300 Km/h in case of T2X communication (using Winner channel model). Fig. 7 and 8 give V2X and T2X simulation results respectively. These figures show the BER versus SNR in this case study. We can notice that the correlation level has a not negligible impact on the model. Indeed passing the low correlation in high correlation, the communication quality deteriorates in both the case of the V2X that in the case of the T2X. For example in the case of V2X, at SNR = 10 dB, the BER is of the order of 10E-3 for the low correlation as it passes around 10e-2 to the high correlation. The same result is obtained in the case of T2X communication.

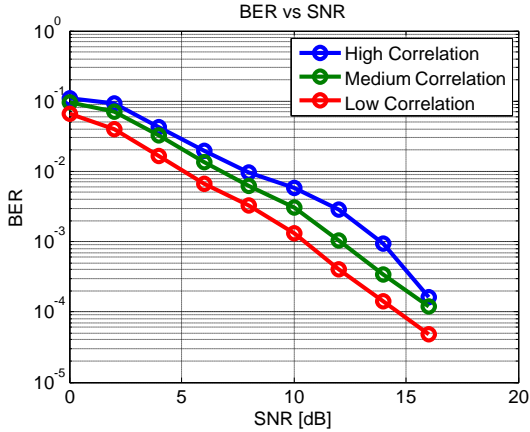

Fig. 7. BER vs SNR compared High Correlation, Medium Correlation and Low Correlation (V2X Communication)

For the evaluation of the PER, the numbers of errors in the packet will be divided by the number of packets. The PER is taken over the last 50 frames. The same study with the BER is performed with the PER. Fig.9 and 10 show the PER vs SNR for V2X and T2X communication respectively. In this case, the same observation made in the study of BER is done. The system performance degrades as a function of correlation level.

Throughout the remainder of the study, we considered the case of a Low Correlation.

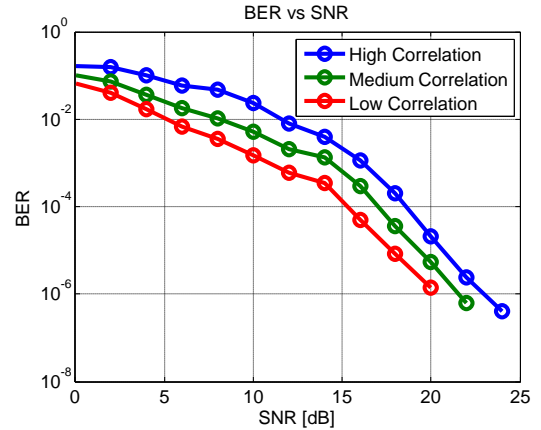

Fig. 8. BER vs SNR compared High Correlation, Medium Correlation and Low Correlation (T2X Communication)

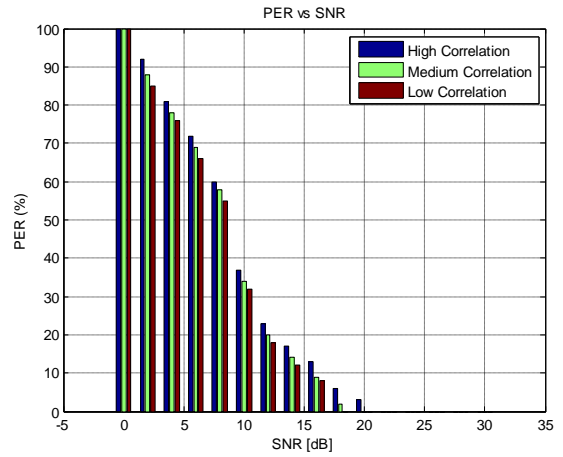

Fig. 9. PER vs SNR compared High Correlation, Medium Correlation and Low Correlation (V2X Communication)

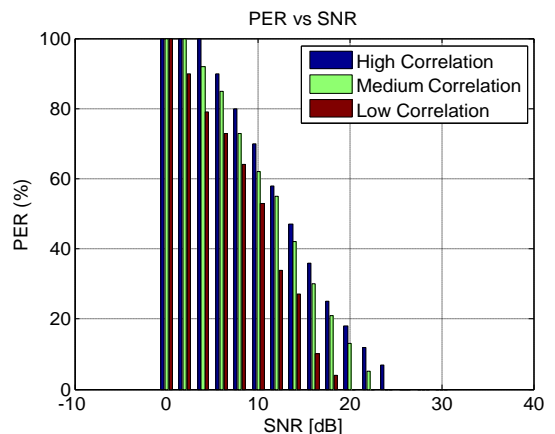

Fig. 10. PER vs SNR compared High Correlation, Medium Correlation and Low Correlation (T2X Communication)

B. Mobile Velocities and Modulations Schemes

To evaluate the performance of LTE-PLD model according to the velocity, three levels of velocity are considered for each type of communication (using the WINNER II channel model):

- For V2X communication: 50 km/h, 90 km/h and 120 km/h
- For T2X communication: 100 km/h, 300 km/h and 500 km/h.

We then evaluated the BER and PER vs. SNR with different speeds and this for each of the three type of modulation namely QPSK, 16QAM and 64QAM. Fig. 11a, 11b and 11c show the simulation results for QPSK, 16QAM and 64QAM modulations respectively in the case of V2X communications. We note firstly that the performance

change depending on the velocity and secondly the QPSK and 16QAM support more these velocity levels than 64QAM modulation. Indeed, passing a velocity of 50 km/h to 120 km/h increases the BER averaged about one third of its value. In addition, a good communication quality is obtained for all three levels of speed at SNR < 5 dB for QPSK, at SNR < 15 dB for 16QAM and at SNR < 25 dB for 64QAM. This leads to the conclusion that the whole LTE-PLD model resists to high speed mobility while providing a good quality of communication.

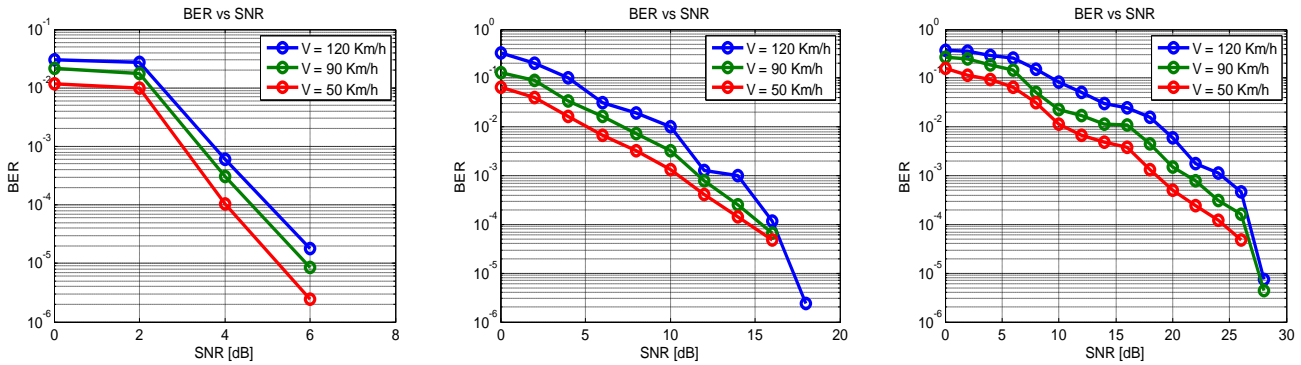

Fig. 11. BER vs SNR compared Mobile Velocities and Modulations (V2X Communication): a) QPSK, b) 16QAM, c) 64QAM

Fig. 12a, 12b and 12c show the results of the PER vs. SNR. In parallel, we find a good quality of communication on all configurations Hereafter SNR = 25dB. By going against the

velocity of 50 km/h to 120 km/h, PER increases on average by 15%.

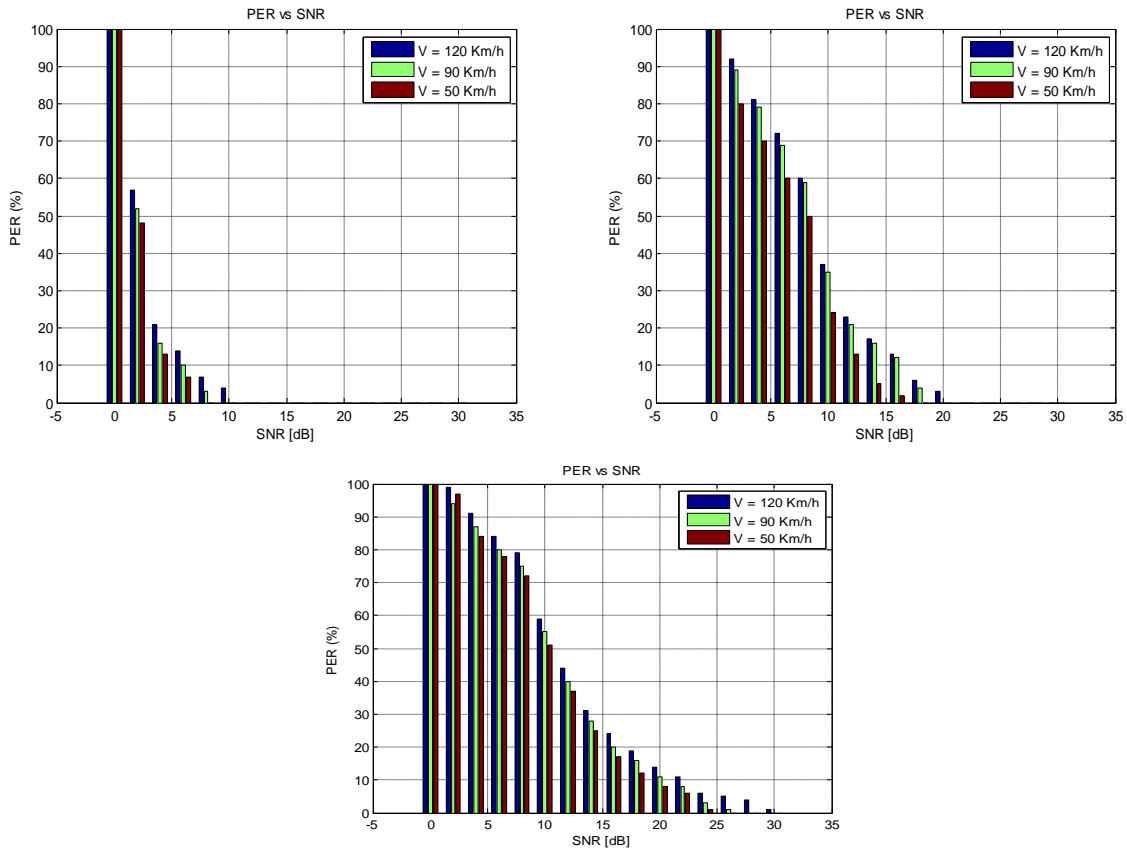

Fig. 12. PER vs SNR compared Mobile Velocities and Modulations (V2X Communication): a) QPSK, b) 16QAM, c) 64QAM

Fig. 13a, 13b and 13c respectively show the results in the case of T2X communications. The same observations are made. A good communication quality is obtained for all three levels at SNR <8 dB for QPSK modulation, at SNR <18 dB

for 16QAM and at SNR <30 dB for 64QAM. LTE-PLD model can thus ensure good quality of communication in context of very high speed mobility.

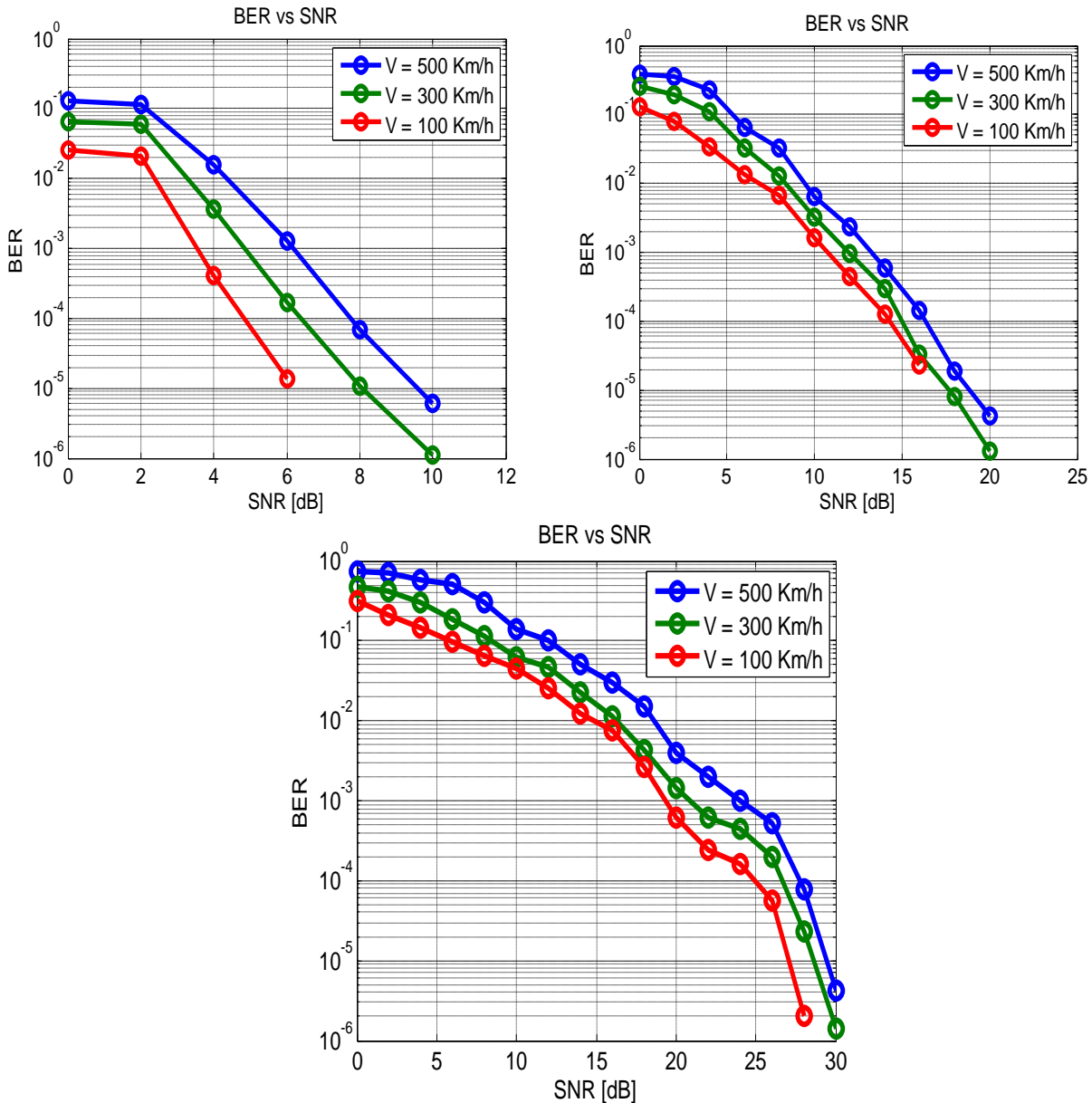

Fig. 13. BER vs SNR compared Mobile Velocities and Modulations (T2X Communication): a) QPSK, b) 16QAM, c) 64QAM

These results are confirmed by the study of the PER vs. SNR (Fig 14a, 14b and 14c) corresponding to QPSK, 16QAM and 64QAM. Good communication quality (PER <10%) is

achieved on average with SNR = 6 dB for QPSK modulation, SNR = 15 dB for 16QAM and SNR = 25 dB for 64QAM, and for all three levels velocity.

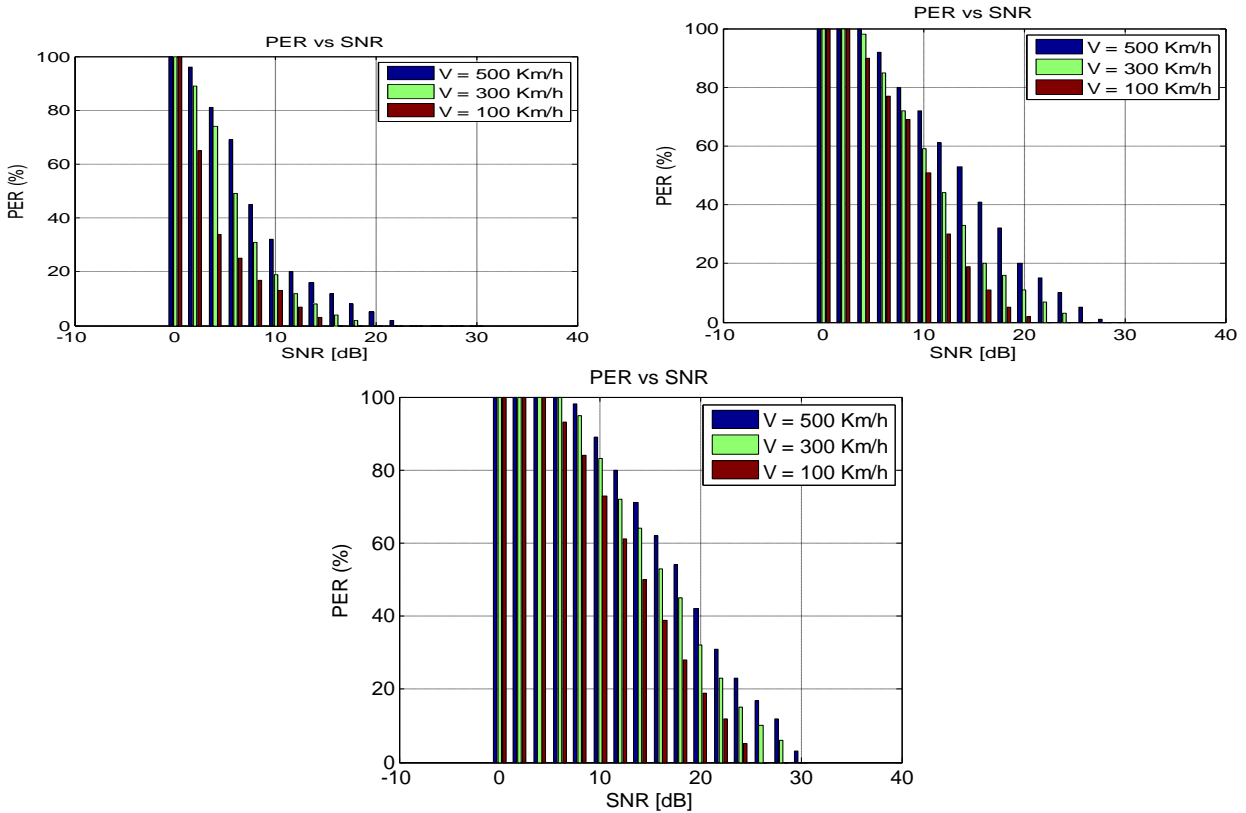

Fig. 14. PER vs SNR compared Mobile Velocities and Modulations (T2X Communication): a) QPSK, b) 16QAM, c) 64QAM

C. Channel Models Comparison

To verify that the selected channel model is more suitable for LTE-PLD model, we compared the MIMO channel model Frequency Selective High Mobility (FSHM) to WINNER II (WII-C2 for V2X com. and WII-D2 for T2X com.) channel model rated the BER vs. SNR for the three types of modulation. In this case study, mobility speed is 90 km/h for V2X communication and 300 km/h for the T2X communication for a low correlation. Fig. 15a and 15b

correspond to the VTX and T2X respectively, we can see that the system performance is very degraded in the case of FSHM channel while in the case of the WINNER II channel model, good quality communication is achieved on SNR > 25 dB. This is explained by the fact that the WINNER II model takes into account all the scenarios in the context of high speed mobile, which is not the case FSHM model.

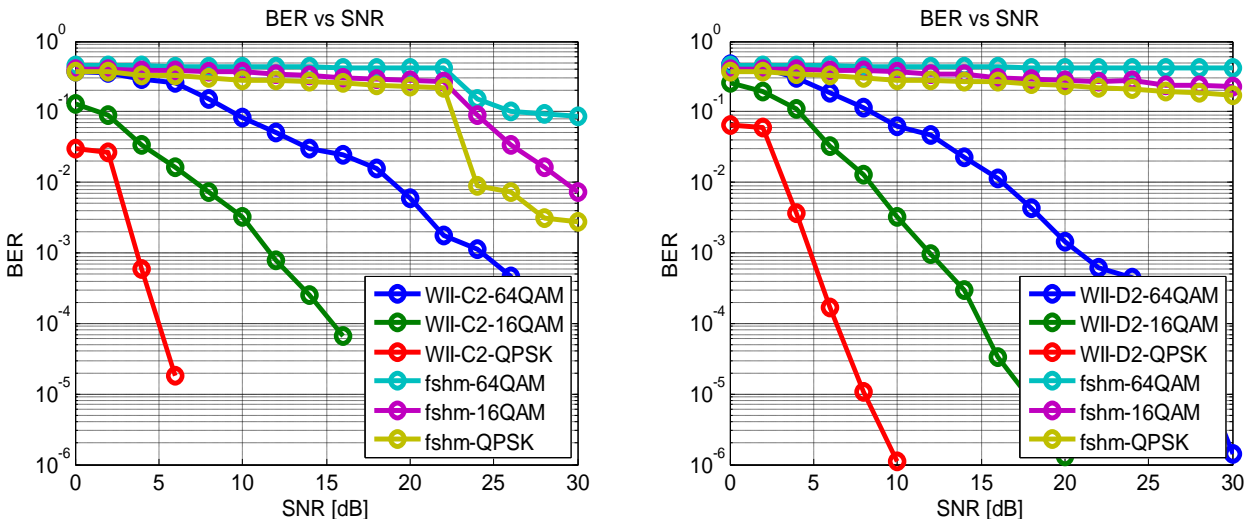

Fig. 15. BER vs SNR compared FSHM model and WINNER II model: a) V2X Communication, b) T2X Communication

V. CONCLUSION

In this paper, the performance including BER and PER of LTE Physical Layer Downlink model when applied to V2X communication and T2X communication has been studied. Measurements of BER and PER were also performed in different MIMO correlations. Different levels of velocity to evaluate the Doppler impact, different modulation schemes such as QPSK, 16QAM and 64QAM and different channel model such as MIMO Channel model and WINNER II Channel model have been considered. In all the simulated configurations, it has been shown that, the LTE-PLD model proposed for our studies ensures good quality communication even with a very high mobility rate in both V2X and T2X communication. This confirms the hypothesis that LTE could be exploited for these types of applications in the transportation sector. However, it would be interesting in the future to generalize the study in different scenarios including uplink communication context. We project also to evaluate the model performance for transmission images and videos. Finally, the experimental results demonstrated that LTE Physical Layer Downlink application requires powerful processing capabilities. It could be interesting to evaluate the implementation of this application on a FPGA circuit.

REFERENCES

- [1] H. Saghir, M. Heddebaut, F. Elbahhar, J.M. Rouvaen, A. Rivenq, "Train-to-wayside wireless communication in tunnel using ultra-wideband and time reversal," Ed. Elsevier, Transportation Research Part C: Emerging Technologies vol. 17, No. 1, 2009, pp. 81-97.
- [2] K. Trichias, "Modeling and Evaluation of LTE in Intelligent Transportation Systems," Master of Science Thesis, University of Twente, TNO Innovation for Life, 2011, pp 1-105.
- [3] Z. H. Mir, "LTE and IEEE 802.11p for vehicular networking: a performance evaluation," EURASIP Journal on Wireless Communications and Networking, 2014, pp. 1-15.
- [4] R. Gallardo, D. Makrakis, HT Mouftah, "Performance analysis of the EDCA medium access mechanism over the control channel of an IEEE 802.11p WAVE vehicular network," Proceeding of the IEEE International Conference on Communications, Dresden, June 2009, pp. 1-6.
- [5] C. L. Bencheton, "LTE in transport: the new service department," Congress ATEC ITS France: The meet of Intelligent Mobility, 2014, pp. 1-10.
- [6] Radio Spectrum Committee, Working Document: Spectrum Requirements for Railway Applications, European Commission (2010).
- [7] Matlab SW documentation of WIM2 model, issue 1.0, version 1.0, Project Wireless World Initiative New Radio, IST-4-027756.
- [8] A. Bertout, E. Bernard, "Next Generation of Railway and Metros Wireless Communication Systems," Aspect-IRSE, 2012, pp. 1-8.
- [9] S. Sesia, T. Issam, M. Baker, "LTE, The UMTS Long Term Evolution, from theory to practice," Willey edition, 2009, 794 p.
- [10] 3GPP TR 25.913 v8.0.0, "Requirements for Evolved UTRA (E-UTRA) and Evolved UTRAN (E-UTRAN) (Release 8)," 3GPP Technical Specification Group Radio Access Network, Technical Report, 2008.
- [11] D. Mandoc, "LTE/SAE – The Future Railway Mobile Radio System: Long-Term Vision on Railway Mobile Radio Technologies," Technical Report. UIC, November 2009.
- [12] 3GPP Technical Specification Group Radio Access Network; Evolved Universal Terrestrial Radio Access (E-UTRA); Physical channels and Modulation (Release 10)", 3GPP TS 36.211 v10.0.0 (2010-12).
- [13] E. Dahlman, S. Parkvall, J. Skold, "4G LTE/LTE-Advanced for Mobile Broadband," Elsevier, 2014.
- [14] 3GPP Technical Specification Group Radio Access Network; Evolved Universal Terrestrial Radio Access (E-UTRA); Physical layer procedures (Release 10)", 3GPP TS 36.213 v10.0.0 (2010-12).
- [15] A. Ghosh, R. Ratasuk, "Essentials of LTE and LTE-A," Cambridge University Press, Cambridge, 2011, 264 p.
- [16] F. Rezaei, M. Hempel, H. Sharif, "LTE PHY Performance Analysis under strict 3GPP parameters," Vehicular Technology Conference VTC, September 2010. pp. 1-6.
- [17] IST-WINNER II Deliverable 1.1.2 v.1.2, "WINNER II Channel Models," IST-WINNER2, Tech. Report, 2008.