



HAL
open science

Fuzzy unknown input observer for understanding sitting control of persons living with spinal cord injury

Mathias Blandeau, Víctor Estrada Manzo, Thierry-Marie Guerra, Philippe Pudlo, François Gabrielli

► To cite this version:

Mathias Blandeau, Víctor Estrada Manzo, Thierry-Marie Guerra, Philippe Pudlo, François Gabrielli. Fuzzy unknown input observer for understanding sitting control of persons living with spinal cord injury. *Engineering Applications of Artificial Intelligence*, 2018, 67, pp.381-389. 10.1016/j.engappai.2017.09.016 . hal-03428425

HAL Id: hal-03428425

<https://uphf.hal.science/hal-03428425v1>

Submitted on 22 Sep 2023

HAL is a multi-disciplinary open access archive for the deposit and dissemination of scientific research documents, whether they are published or not. The documents may come from teaching and research institutions in France or abroad, or from public or private research centers.

L'archive ouverte pluridisciplinaire **HAL**, est destinée au dépôt et à la diffusion de documents scientifiques de niveau recherche, publiés ou non, émanant des établissements d'enseignement et de recherche français ou étrangers, des laboratoires publics ou privés.

Fuzzy Unknown Input Observer for Understanding Sitting Control of Persons living with Spine Cord Injury

M. Blandeau*, V. Estrada-Manzo**,
T.M. Guerra*, P. Pudlo*, and F. Gabrielli***

* Univ. Valenciennes, CNRS, UMR 8201 - LAMIH, F-59313 Valenciennes, France
(Tel: 03 27 51 12 34; e-mail: mathias.blandeau@univ-valenciennes.fr).

** Department of Electrical and Electronics Engineering, Sonora Institute of Technology, 5 de febrero 818 Sur, CP 85000, Obregon, Sonora, Mexico

*** Neuro-Dol, UMR Inserm 1107, Université Clermont Auvergne, Faculté de Chirurgie Dentaire, 2 Rue de Braga, 63100 Clermont-Ferrand, France

Abstract: The present paper introduces a simple model to study sitting control for persons with complete thoracic spine cord injury. The system is obtained via Lagrangian techniques; this procedure leads to a nonlinear descriptor form, which can be written as a Takagi-Sugeno model. A first attempt to estimate the sitting control in disabled people is done via an unknown input observer. The conditions are expressed as linear matrix inequalities, which can be efficiently solved. Simulation results validate the proposed methodology as the observations are coherent with and without perturbations.

Keywords: Unknown input observer, Takagi-Sugeno models, Inverted pendulum, Spine Cord Injury, Sitting movement, Descriptor Form.

1. INTRODUCTION

People living with a complete spine cord injury (SCI) lose all sensibility and mobility below their injury level. An injury in the lumbar region would result in the loss of the lower limbs and any higher injury will affect the abdominal belt, the back and intervertebral muscles which are required to finely adjust the inherently unstable human spine (Crisco et al. 1992; Silfies et al. 2003) or stabilize it in the presence of perturbation. In the absence of those muscles, people living with SCI can use instead their upper limbs and head as a compensatory strategy to maintain equilibrium (Grangeon et al. 2012) as they are trained in rehabilitation (Janssen-Potten et al. 2001).

The majority of existing models for the study of sitting stability are linked-segment model allowing simple mechanical representation of the anatomical complexity of the body with active and passive contributions (Panjabi 1992), nevertheless the representation are often inappropriate for the application to the SCI sitting stability because the trunk and arms are considered rigid (Cholewicki et al. 1999; Vette et al. 2010) or because the muscular activity is concentrated at the lumbar joint (Reeves et al. 2009; Tanaka and Granata 2007). The H2AT model (for “head, two arms and trunk”), a variation of the inverted pendulum, taking into account the action of the upper limbs and head has been proposed for this specific topic (Blandeau et al. 2016a).

Modeling mechanical systems leads to non-linear descriptor with an invertible inertia matrix (Lewis et al. 2003) which can be exactly represented by Takagi-Sugeno (TS) model via the sector nonlinearity approach (Ohtake et al. 2001; Taniguchi et al. 1999). This approach has been adapted to biomechanical systems (Guelton et al. 2008) combined with direct Lyapunov method to develop an unknown input observer (UIO) for the estimation of unmeasured variables and inputs but, the convergence conditions were expressed in terms of bilinear matrix inequalities (BMI), which are difficult to solve. Recently (Guerra et al. 2015) solved this problem and obtained a linear matrix inequality (LMI) constraints problem (Boyd et al. 1994). This methodology is adopted in the current paper; its objective is to understand the way an individual with complete thoracic SCI maintains its equilibrium by estimating internal variables of force generation via UIO and TS descriptor models. Moreover the H2AT model in its TS form presents the well-known problem of non-measurable premise variables. This problem, in its general form is still one open problem of the TS modelling (Ichalal et al. 2016). This problem has been solved in our particular case using a robust-like control approach for the convergence of the state error estimation. Thus, the main interest is to guarantee the convergence of the general observer including the non measured premise variable without extra assumptions such that Lipchitz conditions that are generally used.

As people living with SCI, the H2AT is unstable in open-loop, the first step is then to derive an “internal” control law, compatible with the human behaviour, to get a stable closed-loop system. Because all human action are delayed, from sensing a perturbation to muscle activation (Reeves et al. 2007), the design of the control law is based on a time-varying input control law from (Yue and Han 2005) adapted to the descriptor form. A problem of implementation also appears as the control law is delay-distributed. This problem has been solved using a nonlinear dynamic extension to end with a dynamic feedback control law.

This paper is organized as follows: Section 2 presents the modeling of H2AT via Lagrangian techniques, the design and implementation of the control law and the TS modeling; Section 3 explains the way to derive a UIO for the states and input observation, Section 4 provides the simulation results and discusses the obtained results and Section 5 concludes the paper and gives future works.

2. PROBLEM STATEMENT

The H2AT model has been introduced in previous works (Blandeau et al. 2016a). H2AT stands for “head, two arms and trunk” and introduces a new way to model sitting control by taking into account the action of upper segments (upper limbs and head) in the stabilization process.

2.1 Modeling

The H2AT pendulum is an extended version of the planar inverted pendulum consisting of two rods. The first one represents the trunk as a classical inverted pendulum while the second rod represents the head and arms slides at the top of the first one. The controlling force $F(t)$ will make the upper rod slide on the lower one. Figure 1 shows the H2AT system scheme.

This model is generic and just requires a minimum of biomechanical parameters. For the simulations, we consider a 80 Kg male subject. As arms and trunk mass do not change between control subject and SCI subject (Jones et al. 2003), we can use regression rules to get segment mass and length (Dumas et al. 2007): $m_1 = 16.1$ Kg stands for the mass of the upper segment, corresponding to the head, neck, and arms; $m_2 = 26.64$ Kg is the mass of the trunk; $l_0 = 477$ mm is the length of the trunk; and $l_c = 276.66$ mm is the length of the centre of mass of the trunk. A full neck flexion with both arms stretched gives a value of $x = 105.27$ mm whereas an extension of the neck and arms gives $x = -75.18$ mm (Kapandji 2005). The resulting compact

$$\text{set is } \Omega_x = \left\{ \begin{array}{l} -0.075 \leq x \leq 0.105 \\ -0.175 \leq \theta \leq 0.349 \\ -0.5 \leq \dot{\theta} \leq 0.5 \end{array} \right\} \text{ in meters, radians and rad/s.}$$

To obtain the dynamic equations of the system, we calculate its Lagrangian $L = K - U$ where K , U are the kinetic and potential energies of the system, respectively. Thus, consider $K = K_1 + K_2$ with $K_1 = \frac{m_1}{2} (l_0^2 \dot{\theta}^2 + \dot{x}^2 + x^2 \dot{\theta}^2 - 2l_0 \dot{x} \dot{\theta})$, $K_2 = \frac{1}{2} m_2 l_c \dot{\theta}^2$; and $U = U_1 + U_2$ with $U_1 = m_1 g (l_0 \cos(\theta) + x \sin(\theta))$, $U_2 = m_2 g l_c \cos(\theta)$.

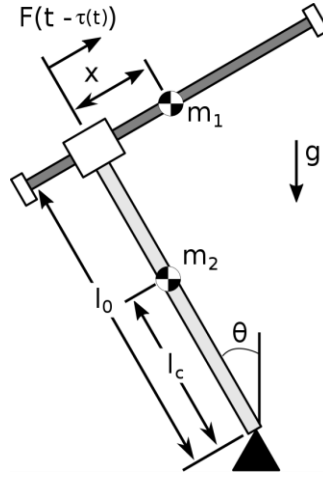

Figure 1. H2AT Pendulum

Hence, by considering

$$\frac{d}{dt} \frac{\partial L}{\partial \dot{x}} - \frac{\partial L}{\partial x} = F(t - \tau(t)) \quad \text{and} \quad \frac{d}{dt} \frac{\partial L}{\partial \dot{\theta}} - \frac{\partial L}{\partial \theta} = 0,$$

we obtain

$$\begin{aligned} 0 &= m_1 \ddot{x}_l(t) - m_1 l_0 \ddot{\theta}(t) - m_1 x_l(t) \dot{\theta}^2(t) + m_1 g \sin(\theta(t)) - F(t - \tau(t)) \\ 0 &= -m_1 l_0 \ddot{x}_l(t) + J(x_l(t)) \ddot{\theta}(t) + 2m_1 x_l(t) \dot{x}_l(t) \dot{\theta}(t) - (m_1 l_0 + m_2 l_c) g \sin(\theta(t)) + m_1 g x_l(t) \cos(\theta(t)), \end{aligned} \quad (1)$$

where $J(x_l(t)) = m_1(l_0^2 + x_l^2(t)) + m_2 l_c^2$. The input includes a time-varying delay $\tau(t)$ due to neural transmission and the muscle force generation and is varying according to the individual; a classical range is for example $60\text{ms} \pm 10\text{ms}$. Of course, due to the absence of control of the trunk and intervertebral muscles, the model exhibits unstable open-loop behaviour, as shown for example, in Fig. 2, using the H2AT initial parameters at $t=0\text{s}$: $\theta = -0.175\text{rad}$, $x = 0\text{mm}$, and $F = 100\text{N}$. Because of the gravity effect, the trunk should have continued in negative values but with x increasing fast, the trunk rotates in the opposite direction and ends up falling down.

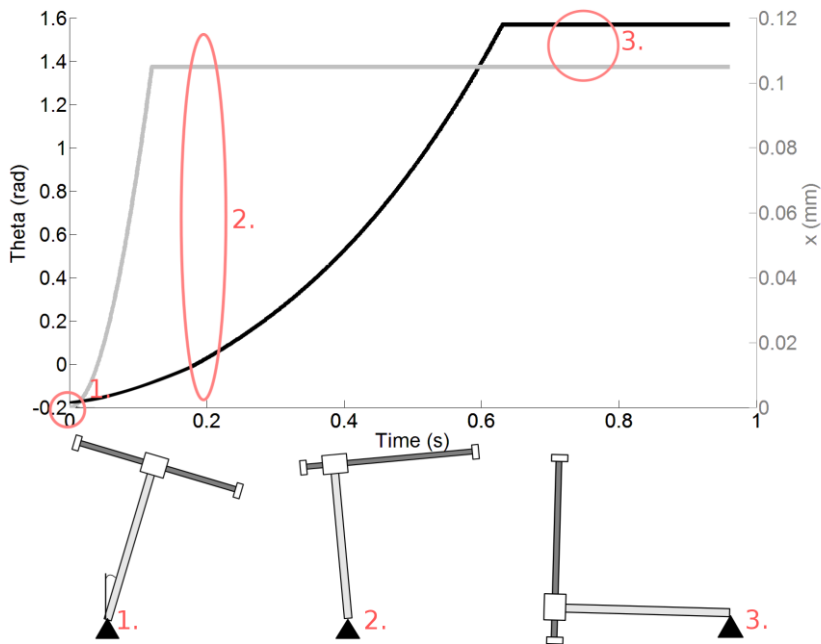

Fig. 2. Evolution in time of θ (black line) and x (gray line) with a constant input.

The goal of this study is to estimate the delayed input $F(t-\tau(t))$. To this end, system (1) is rewritten in a state-space form using the following state vector:

$$x(t) = [x_l(t) \quad \dot{x}_l(t) \quad \theta(t) \quad \dot{\theta}(t)]^T \in \mathbb{R}^4, \text{ hence}$$

$$\begin{aligned} E(x_l(t))\dot{x}(t) &= A(x_l(t), \theta(t), \dot{\theta}(t))x(t) + BF(t-\tau) \\ y(t) &= Cx(t), \end{aligned} \quad (2)$$

where $y(t) \in \mathbb{R}^2$ is the output of the system, the matrices are defined as follows:

$$A(x_l, \theta, \dot{\theta}) = \begin{bmatrix} 0 & 1 & 0 & 0 \\ 0 & 0 & -m_1 g \frac{\sin(\theta)}{\theta} & m_1 x_l \dot{\theta} \\ 0 & 0 & 0 & 1 \\ -m_1 g \cos(\theta) & -2m_1 x_l \dot{\theta} & (m_1 l_0 + m_2 l_c) g \frac{\sin(\theta)}{\theta} & 0 \end{bmatrix}, \quad E(x_l) = \begin{bmatrix} 1 & 0 & 0 & 0 \\ 0 & m_1 & 0 & -m_1 l_0 \\ 0 & 0 & 1 & 0 \\ 0 & -m_1 l_0 & 0 & m_1 (l_0^2 + x_l^2) + m_2 l_c^2 \end{bmatrix},$$

$$B = [0 \quad 1 \quad 0 \quad 0]^T, \text{ and } C = \begin{bmatrix} 1 & 0 & 0 & 0 \\ 0 & 0 & 1 & 0 \end{bmatrix}.$$

Notice that the matrix $E(x_l)$ is regular, i.e., it is invertible $\forall x_l \in \mathbb{R}$ and one of the major point is that $\dot{\theta}(t)$ appearing in $A(\theta, x_l, \dot{\theta})$ is a non-measured variable.

2.2 Internal control

Model (1) being open-loop unstable, an internal control has to be designed in a way that the generalized stabilized model (see Fig. 2) is stable and allows designing an observer. In order to reproduce a human-like control, we need to take into account various delays: the transmission from sensor-to-controller and controller-to-actuator and also the electromechanical delay which represents the time for the muscle to generate force when receiving an electric impulse. Those delays are not constant, because they might depend on which muscle is activated and in what direction is given the information to the brain. Thus, we are faced to the control of a descriptor model with varying time delays on the control. The proposed approach is extended from a robust control of input delayed uncertain models (Yue and Han 2005) using a control law depending on the mean delay τ_0 (based on physiological data) and a constant gain K of the form:

$$u(t) = K \left[x(t) + \int_{t-\tau_0}^t e^{A(t-s-\tau_0)} Bu(s) ds \right]. \quad (3)$$

To obtain the gain K , we choose to reduce the general model (2) to the following models, i.e. linear descriptor with uncertainties:

$$\begin{aligned} E\dot{x}(t) &= (A + \Delta A(t))x(t) + Bu(t-\tau(t)) \\ y(t) &= Cx(t) \end{aligned} \quad (4)$$

The result using a LMI problem constraint and the proof of stability can be found in (Blandeau et al. 2016b). It follows directly the results of (Yue and Han 2005) and is out of the scope of this paper.

Remark 1: the purpose of the work is to design an unknown input observer for nonlinear model (2). Nevertheless, being open-loop unstable, a control part has to be added via (3) in order to generate a stabilizing signal $F(t-\tau)$. The purpose of the work is not a full study of this control, in terms of stability and robustness. Therefore, reducing nonlinear model (2) to the uncertain model (4) was found enough to satisfactorily stabilize (2) according to the restricted domain Ω_x .

A more difficult problem is the implementation of delay-distributed control laws. Effectively, its approximation includes an integration step, thus it requires a method insensitive to this step in order to guarantee that stability properties are preserved via the approximation. To solve this problem, a dynamic inversion of a fixed point problem is used (Georges et al. 2007). The

main idea is to replace the problem of finding a solution to the equation $G(x,t)=0$, with $G(x,t)$ a non-linear C^1 function, by finding a solution of the differential equation with $\Lambda > 0$:

$$\dot{G}(x,t) + \Lambda \times G(x,t) = 0 \Leftrightarrow \frac{\partial G(x,t)}{\partial x} \dot{x} + \frac{\partial G(x,t)}{\partial t} + \Lambda \times G(x,t) = 0 \quad (5)$$

Supposing also that the Jacobian matrix $\frac{\partial G(x,t)}{\partial x}$ is regular, then:

$$\dot{x} = - \left(\frac{\partial G(x,t)}{\partial x} \right)^{-1} \left(\frac{\partial G(x,t)}{\partial t} + \Lambda G(x,t) \right) \quad (6)$$

The solution of (5) is: $G(x,t) = e^{-\Lambda t} G(x(0),0)$, therefore $G(x,t) \xrightarrow[t \rightarrow \infty]{} 0$ and $\Lambda > 0$ can be set to control the convergence. Notice that the control law (3) to be implemented uses a constant delay τ_0 . At the end, the approximation made (10) takes profit of the robustness to time delay uncertainties of the “ideal” control (3). Let us define a first order approximation of the state:

$$\hat{x}(t, t + \tau_0) = x(t) + \int_t^{t+\tau_0} \dot{x}(s) ds = x(t) + \int_t^{t+\tau_0} (\bar{A}x(s) + \bar{B}u(s - \tau_0)) ds \quad (7)$$

With: $\bar{x}(t) = \begin{bmatrix} \hat{x}(t, t + \tau_0) \\ u(t) \end{bmatrix}$, $\bar{A} = E^{-1}A$ and $\bar{B} = E^{-1}B$; the problem is to find a solution to the fixed point problem:

$$\bar{x}(t) = H(\bar{x}(t), x(t)) = \begin{bmatrix} x + \tau_0 (\bar{A}\hat{x}(t, t + \tau_0) + \bar{B}u(t)) \\ Ke^{-\bar{A}\tau_0} (x + \tau_0 (\bar{A}\hat{x}(t, t + \tau_0) + \bar{B}u(t))) \end{bmatrix} = \begin{bmatrix} I \\ Ke^{-\bar{A}\tau_0} \end{bmatrix} x + \tau_0 \begin{bmatrix} \bar{A} & \bar{B} \\ Ke^{-\bar{A}\tau_0} \bar{A} & Ke^{-\bar{A}\tau_0} \bar{B} \end{bmatrix} \bar{x}. \quad (8)$$

Thus considering $G(\bar{x}, x) = \bar{x}(t) - H(\bar{x}(t), x(t))$ and applying (6):

$$\frac{\partial H(\bar{x}(t), x(t))}{\partial \bar{x}(t)} = \begin{bmatrix} \frac{\partial H}{\partial \hat{x}(t, t + \tau_0)} & \frac{\partial H}{\partial u} \end{bmatrix} = \begin{bmatrix} \tau_0 \bar{A} & \tau_0 \bar{B} \\ \tau_0 Ke^{-\bar{A}\tau_0} \bar{A} & \tau_0 Ke^{-\bar{A}\tau_0} \bar{B} \end{bmatrix}; \quad (9)$$

and after some manipulations:

$$\begin{cases} \dot{\bar{x}} = \begin{bmatrix} I - \tau_0 \bar{A} & -\tau_0 \bar{B} \\ -\tau_0 Ke^{-\bar{A}\tau_0} \bar{A} & I - \tau_0 Ke^{-\bar{A}\tau_0} \bar{B} \end{bmatrix}^{-1} \left(\begin{bmatrix} I \\ Ke^{-\bar{A}\tau_0} \end{bmatrix} (Ax + Bu(t - \tau_0)) - \Lambda \left(\begin{bmatrix} I - \tau_0 \bar{A} & -\tau_0 \bar{B} \\ -\tau_0 Ke^{-\bar{A}\tau_0} \bar{A} & I - \tau_0 Ke^{-\bar{A}\tau_0} \bar{B} \end{bmatrix} \bar{x} - \begin{bmatrix} I \\ Ke^{-\bar{A}\tau_0} \end{bmatrix} x \right) \right) \\ u(t) = [0 \ 1] \bar{x}(t). \end{cases} \quad (10)$$

Thus the way to resolve the implementation problem of (3) is done through a dynamic state feedback control law that guarantees the convergence of $\bar{x}(t) - H(\bar{x}(t), x(t))$ according to $\Lambda > 0$. In order to show the internal loop, that represents the stabilized person control, some simulations are presented. The solution to the problem is $K = [8126 \ 1629 \ -6954 \ -1346]$ and $\Lambda = 50$. Initial conditions are taken as $x(0) = [0 \ 0 \ 0 \ 0.01]^T$ and a perturbation, simulating an 0.05 rad/s^2 impulsion on the acceleration during $0.2s$, is used at time $2s$ (Fig. 3 dashed blue signal). Fig. 3 part left shows the delayed control $u(t - \tau(t))$ issued from the dynamic state feedback (10) and part right the variable $\dot{\theta}(t)$. The controller as implemented is perfectly able to stabilize the nonlinear model for these conditions.

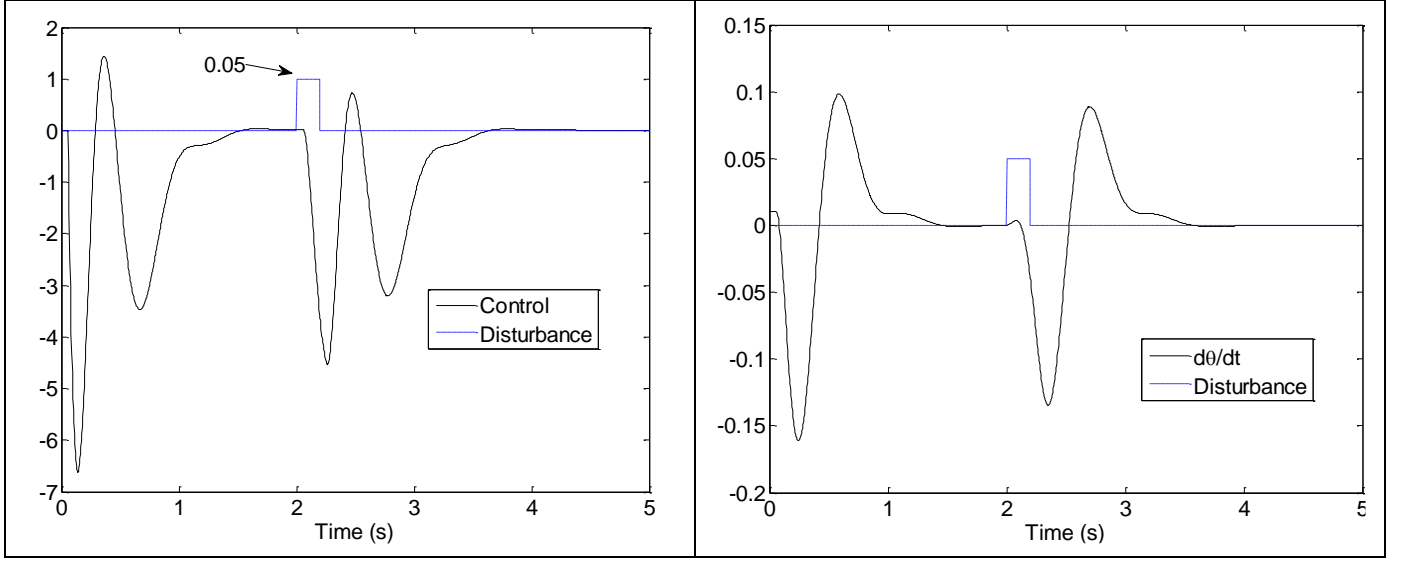

Fig. 3 Control (10) of nonlinear model (2) with initial conditions $x(0) = [0 \ 0 \ 0 \ 0.01]^T$ and disturbance (dashed blue line).

Left: control signal, right: angular speed $\dot{\theta}(t)$

The internal control being done, the goal is now to derive an observer that allows building the state and moreover the unknown internal input $u(t - \tau(t))$.

2.3 TS descriptor form

The nonlinear descriptor model (2) can be written as an equivalent TS descriptor model form (Taniguchi et al. 1999). As in (Guerra et al. 2006) we consider the following notation: $\alpha(t)$ the measured premise variables and $\beta(t)$ the non-measured variable. Therefore (2) can be transformed as:

$$\sum_{k=1}^{r_\alpha} v_k(z) E_k \dot{x}(t) = \sum_{i=1}^{r_\alpha} \sum_{j=1}^{r_\beta} w_i(\alpha_i) w_j(\beta_j) A_{ij} x(t) + B d(t), \quad (11)$$

with the usual notations $E_v = \sum_{k=1}^{r_\alpha} v_k(z) E_k$ and $A_{\alpha\beta} = \sum_{i=1}^{r_\alpha} \sum_{j=1}^{r_\beta} w_i(\alpha_i) w_j(\beta_j) A_{ij}$, (11) can be rewritten in a compact form:

$$E_v \dot{x}(t) = A_{\alpha\beta} x(t) + B d(t) \quad (12)$$

Let us derive the different parts of (11) coming from the descriptor nonlinear model (2). From (2), three nonlinear terms can be identified in matrix $A(\theta, x_i \times \dot{\theta})$: $\frac{\sin(\theta(t))}{\theta(t)}$, $\cos(\theta(t))$ and $x_i(t) \times \dot{\theta}(t)$ and one nonlinear term in $E(x_i)$: $x_i^2(t)$.

Assumption 1: Let us consider that $\theta(t) \in [-10^\circ, 20^\circ]$, then

$$\left| \frac{\sin(\theta(t))}{\theta(t)} - \cos(\theta(t)) \right| < 4\% \quad (13)$$

Therefore for the TS model considers that $\frac{\sin(\theta(t))}{\theta(t)} \approx \cos(\theta(t))$. This assumption will be validated on the trials; it allows decreasing the number of fuzzy rules and thus reducing the conservatism of the solution and will be validated on the trials.

Therefore, the model resumes to two nonlinearities for $A(\theta, x_l \times \dot{\theta})$: $nl_1 = \frac{\sin(\theta(t))}{\theta(t)} \approx \cos(\theta(t))$, and $nl_2 = x_l(t) \times \dot{\theta}(t)$; their corresponding the membership functions (MFs) can be constructed with the following weighting functions (WFs), $nl_j(\cdot) \in [\underline{nl}_j, \overline{nl}_j]$:

$$w_0^j(\cdot) = \frac{nl_j(\cdot) - \underline{nl}_j}{\overline{nl}_j - \underline{nl}_j}, \quad w_1^j(\cdot) = 1 - w_0^j(\cdot), \quad j \in \{1, 2\}; \quad (14)$$

while for the left-hand side yields: $v_1(x_l) = \frac{x_l^2(t)}{x_l^2}$, $v_2(x_l) = 1 - v_1(x_l)$

Thus we consider the following descriptor TS model:

$$\sum_{k=1}^2 v_k(x_l) E_k \dot{x}(t) = \sum_{i=1}^2 \sum_{j=1}^2 w_{d^i}^j(\theta) w_{x_l}^j(x_l \times \dot{\theta}) A_{ij} x(t) + B d(t) \quad (15)$$

with the digit $d^1 = 0$, $d^2 = 1$, and using the previous notation we have for the premise variables: $\alpha(t) = \theta(t)$ and $\beta(t) = x_l(t) \times \dot{\theta}(t)$. In order to show the capability of the TS model to derive trajectories in Ω_x closed to (1) despite assumption 1, the same trial using the same control law implementation as for the previous trial with $x(0) = [0 \ 0 \ 0 \ 0.01]^T$ and the impulsion at time 2s. The maximal error for this trial made on the state variables signals is 0.6% which is clearly acceptable.

At last, remember that the goal is to estimate the unknown input $d(t)$, therefore following (Estrada-Manzo et al. 2015) a dynamic is added in the observer. This dynamic is considered as a 2nd order integrator i.e. $\ddot{d} \approx 0$ and will be discussed further on. Thus consider:

$$\bar{d} = \begin{bmatrix} d \\ \dot{d} \end{bmatrix}, \quad \begin{bmatrix} 1 & 0 \\ 0 & 1 \end{bmatrix} \dot{\bar{d}} = \begin{bmatrix} 0 & 1 \\ 0 & 0 \end{bmatrix} \bar{d} \quad (16)$$

and (15) is extended with (16), using the compact form (12), as:

$$E_v^e \dot{x}^e = A_{\alpha\beta}^e x^e, \quad y = C^e x^e, \quad (17)$$

with $x^e = \begin{bmatrix} x \\ \bar{d} \end{bmatrix}$, $E_v^e = \begin{bmatrix} E_v & 0 \\ 0 & I_2 \end{bmatrix}$, $A_{\alpha\beta}^e = \begin{bmatrix} A_{\alpha\beta} & [B \ 0_{4 \times 1}] \\ 0_{2 \times 4} & \begin{bmatrix} 0 & 1 \\ 0 & 0 \end{bmatrix} \end{bmatrix}$, and $C^e = [C \ 0_{2 \times 2}]$. From (17), it can be seen that $(E_v^e)^{-1}$ exists

$\forall x_l \in \mathbb{R}$.

3. MAIN RESULTS

To derive a TS descriptor observer from (17), as usual the descriptor redundancy approach is first used (Guelton et al. 2008; Taniguchi et al. 1999) corresponding to the augmented TS descriptor:

$$\bar{E} \dot{\bar{x}} = \bar{A}_{\alpha\beta v} \bar{x}, \quad y = \bar{C} \bar{x}, \quad (18)$$

where $\bar{x} = \begin{bmatrix} x^e \\ \hat{x}^e \end{bmatrix}$, $\bar{E} = \begin{bmatrix} I & 0 \\ 0 & 0 \end{bmatrix}$, $\bar{A}_{\alpha\beta v} = \begin{bmatrix} 0 & I \\ A_{\alpha\beta}^e & -E_v^e \end{bmatrix}$, and $\bar{C} = [C^e \ 0]$. An important fact therein is that β is a non-measured variable, therefore, the whole procedure must pay attention to introduce $\hat{\beta} \neq \beta$ and especially the proofs have to be made accordingly. The following augmented observer form proposed (Estrada-Manzo et al. 2015) is adapted to (18):

$$\bar{E} \dot{\hat{x}} = \bar{A}_{\alpha\beta v} \hat{x} + P^{-T} \bar{L}_{\alpha v} (y - \hat{y}), \quad \hat{y} = \bar{C} \hat{x}, \quad (19)$$

where $\hat{\bar{x}} = \begin{bmatrix} \hat{x}^e \\ \gamma^e \end{bmatrix} \in \mathbb{R}^{(2n_x+2)}$ is the estimated vector (the variable γ^e is explicated in (39)) and $\bar{L}_{\alpha v} = \begin{bmatrix} L_{1\alpha v} \\ L_{2\alpha v} \end{bmatrix} \in \mathbb{R}^{(2n_x+2) \times n_y}$ is the

observer gain to be designed, the matrix $P = \begin{bmatrix} P_1 & 0 \\ P_3 & P_4 \end{bmatrix} \in \mathbb{R}^{(2n_x+2) \times (2n_x+2)}$ comes from the Lyapunov function candidate. In order to be clear:

$$\bar{A}_{\alpha\hat{\beta}v} = \sum_{k=1}^{r_\alpha} \sum_{i=1}^{r_\alpha} \sum_{j=1}^{r_\beta} v_k(x_i) w_i(\theta) w_j(x_i \times \hat{\theta}) \bar{A}_{ijk} x(t) \quad (20)$$

Where appears the non-measured variable $\hat{\theta}$. Thus, the augmented estimation error is

$$\bar{e} = \bar{x} - \hat{\bar{x}} = \begin{bmatrix} x - \hat{x} \\ x^e - \hat{x}^e \\ \dot{x}^e - \gamma^e \\ \bar{d} - \hat{d} \\ \dots \\ \bar{d} - \gamma^e \end{bmatrix} \quad (21)$$

and its variation:

$$\bar{E} \left(\dot{\bar{x}} - \dot{\hat{\bar{x}}} \right) = \bar{A}_{\alpha\hat{\beta}v} \bar{x} - \bar{A}_{\alpha\hat{\beta}v} \hat{\bar{x}} - P^{-T} \bar{L}_{\alpha v} (y - \hat{y}) \quad (22)$$

With $\bar{x} = \hat{\bar{x}} + \bar{e}$, (22) writes:

$$\bar{E} \dot{\bar{e}} = (\bar{A}_{\alpha\hat{\beta}v} - P^{-T} \bar{L}_{\alpha v} \bar{C}) \bar{e} + (\bar{A}_{\alpha\hat{\beta}v} - \bar{A}_{\alpha\hat{\beta}v}) \hat{\bar{x}} \quad (23)$$

notice that: $(\bar{A}_{\alpha\hat{\beta}v} - \bar{A}_{\alpha\hat{\beta}v}) \hat{\bar{x}} = \begin{bmatrix} 0 & 0 \\ A_{\alpha\hat{\beta}}^e - A_{\alpha\hat{\beta}}^e & 0 \\ 0 & 0 \end{bmatrix} \begin{bmatrix} \hat{x} \\ \hat{d} \\ \dots \\ \gamma_1^e \\ \gamma_2^e \end{bmatrix} = \begin{bmatrix} 0 \\ (A_{\alpha\hat{\beta}}^e - A_{\alpha\hat{\beta}}^e) \begin{bmatrix} \hat{x} \\ \hat{d} \end{bmatrix} \end{bmatrix}$ and after some easy manipulations:

$$\bar{E} \dot{\bar{e}} = (\bar{A}_{\alpha\hat{\beta}v} - P^{-T} \bar{L}_{\alpha v} \bar{C}) \bar{e} + m_1 x_1(t) \begin{pmatrix} \dot{\theta}(t) - \dot{\hat{\theta}}(t) \\ \begin{bmatrix} 0_6 \\ 0 \\ \dot{\hat{\theta}} \\ 0 \\ -2\dot{\hat{x}}_1 \\ 0_2 \end{bmatrix} \end{pmatrix} \quad (24)$$

And as $\dot{\theta}(t) - \dot{\hat{\theta}}(t)$ is the fourth term of \bar{e} we can write (24) as:

$$\bar{E} \dot{\bar{e}} = (\bar{A}_{\alpha\hat{\beta}v} - P^{-T} \bar{L}_{\alpha v} \bar{C} + m_1 \Delta(t)) \bar{e} \quad (25)$$

with $\Delta(t) \in \mathbb{R}^{12 \times 12}$ a null matrix excepted for the terms: $\Delta_{(8,4)}(t) = x_1(t) \dot{\hat{\theta}}(t)$ and $\Delta_{(10,4)}(t) = -2x_1(t) \dot{\hat{x}}_1(t)$. Consider that for any bounded uncertainty $\mu(t) \in [\underline{\mu}, \bar{\mu}]$ we have: $\mu(t) = c + r \times \delta(t)$ with $\delta(t) \in [-1, 1]$, the center: $c = 0.5(\bar{\mu} + \underline{\mu})$ and the radius $r = 0.5(\bar{\mu} - \underline{\mu})$. Therefore defining accordingly $c_{(8,4)}$, $r_{(8,4)}$, $c_{(10,4)}$ and $r_{(10,4)}$ (25) becomes:

$$\bar{E} \dot{\bar{e}} = (\bar{A}_{\alpha\hat{\beta}v} - P^{-T} \bar{L}_{\alpha v} \bar{C} + m_1 A_c + H \delta(t) F) \bar{e}, \quad (26)$$

with: $H = \begin{bmatrix} 0_{6 \times 2} \\ H_2 \end{bmatrix}$, $H_2^T = \begin{bmatrix} 0 & 1 & 0 & 0 & 0 & 0 \\ 0 & 0 & 0 & 1 & 0 & 0 \end{bmatrix}$; $F = [F_1 \quad 0_{2 \times 6}]$, $F_1 = \begin{bmatrix} 0 & 0 & 0 & m_1 \times r_{(8,4)} & 0 & 0 \\ 0 & 0 & 0 & -2m_1 \times r_{(10,4)} & 0 & 0 \end{bmatrix}$ and A_c being a null

matrix excepted: $A_c(8,4) = c_{(8,4)}$, $A_c(10,4) = c_{(10,4)}$. Let us express $\bar{A}'_{\alpha\hat{\beta}v} = \bar{A}_{\alpha\hat{\beta}v} + m_1 A_c$ in a proper way. In fact it corresponds to replace $A_{\alpha\hat{\beta}}$ issued from (2) using assumption 1, i.e. (15) with:

$$A'_{\alpha\beta} = A_{\alpha\beta} + \begin{bmatrix} 0 & 0 & 0 & 0 \\ 0 & 0 & 0 & m_1 c_{(8,4)} \\ 0 & 0 & 0 & 0 \\ 0 & 0 & 0 & m_1 c_{(10,4)} \end{bmatrix}. \quad (27)$$

Thus $A'^e_{\alpha\beta} = \begin{bmatrix} A'_{\alpha\beta} & [B & 0_{2 \times 1}] \\ 0_{2 \times 4} & \begin{bmatrix} 0 & 1 \\ 0 & 0 \end{bmatrix} \end{bmatrix}$. Therefore we are faced to the convergence of:

$$\bar{E}\dot{\bar{e}} = (\bar{A}'_{\alpha\beta v} - P^{-T} \bar{L}_{\alpha v} \bar{C} + H\delta(t)F)\bar{e}. \quad (28)$$

Remark 2: the main advantage to transform (24) into (26) is to transform the problem into a classical robust stability problem with $\Delta_{(8,4)}(t)$ and $\Delta_{(10,4)}(t)$ depending on bounded variables. Considering the compact set of validity defined previously Ω_x and the trials made we have: $c_{(8,4)} = 0$, $r_{(8,4)} = 0.0526$, $c_{(10,4)} = 0.0016$ and $r_{(10,4)} = 0.0095$.

To ensure the estimation error convergence (23), the following quadratic Lyapunov function is used:

$$V(\bar{e}) = \bar{e}^T \bar{E}^T P \bar{e}, \quad \bar{E}^T P = P^T \bar{E} \geq 0, \quad (29)$$

with P defined in (19), $P_1 = P_1^T > 0$, P_3 and P_4 being a regular matrix.

Theorem 1. Consider the system (18) together with the observer (19). With $\lambda > 0$ a fixed decay rate, if there exist matrices $P_1 = P_1^T > 0$, P_3 , P_4 , L_{1jk} , and L_{2jk} , $i, j \in \{1, \dots, r_\alpha\}$, $k \in \{1, \dots, r_v\}$ and scalar $\gamma > 0$ such that

$$Y_{ijk} < 0 \quad (30)$$

Holds with:

$$Y_{ijk} = \begin{bmatrix} P_3^T A'_{ij} - L_{1jk} C^e + (*) + \gamma F_1^T F_1 + \lambda P_1 & (*) & (*) \\ P_4^T A'_{ij} - L_{2jk} C^e + P_1 - (E_k^e)^T P_3 & -P_4^T E_k^e + (*) & (*) \\ H_2^T P_3 & H_2^T P_4 & -\gamma I_2 \end{bmatrix}; \quad (31)$$

then the estimation error e is asymptotically stable.

Proof. The time-derivative of the Lyapunov function (29) is

$$\dot{V}(\bar{e}) = \bar{e}^T P^T (\bar{A}'_{\alpha\beta v} - P^{-T} \bar{L}_{\alpha v} \bar{C} + H\delta(t)F)\bar{e} + (*) \quad (32)$$

in order to ensure a performance to the convergence error, a decay rate λ is added as:

$$\dot{V}(\bar{e}) = \bar{e}^T P^T (\bar{A}'_{\alpha\beta v} - P^{-T} \bar{L}_{\alpha v} \bar{C} + H\delta(t)F)\bar{e} + (*) \leq -\lambda V(\bar{e}) = \bar{e}^T \begin{bmatrix} -\lambda P_1 & 0 \\ 0 & 0 \end{bmatrix} \bar{e} \quad (33)$$

Hence, convergence is ensured with decay rate λ if:

$$\begin{bmatrix} P_3^T A'_{\alpha\beta} - L_{1\alpha v} C^e + (*) + \lambda P_1 & (*) \\ P_4^T A'_{\alpha\beta} - L_{2\alpha v} C^e + P_1 - (E_v^e)^T P_3 & -P_4^T E_v^e + (*) \end{bmatrix} + P^T H \delta(t) F + (*) < 0 \quad (34)$$

With $\gamma > 0$ and considering that $\delta(t)\delta^T(t) \leq I_2$ the last part of (34) writes:

$$P^T H \delta(t) F + (*) = \begin{bmatrix} P_3^T H_2 \\ P_4^T H_2 \end{bmatrix} \delta(t) F + (*) \leq \gamma^{-1} \begin{bmatrix} P_3^T H_2 \\ P_4^T H_2 \end{bmatrix} \begin{bmatrix} H_2^T P_3 & H_2^T P_4 \end{bmatrix} + \gamma F^T F \quad (35)$$

At last with $F^T F = \begin{bmatrix} F_1^T F_1 & 0 \\ 0 & 0 \end{bmatrix}$ and using Schur's complement (34) holds if:

$$Y_{\alpha\beta v} := \begin{bmatrix} P_3^T A'_{\alpha\beta} - L_{1\alpha v} C^e + (*) + \gamma F_1^T F_1 + \lambda P_1 & (*) & (*) \\ P_4^T A'_{\alpha\beta} - L_{2\alpha v} C^e + P_1 - (E_v^e)^T P_3 & -P_4^T E_v^e + (*) & (*) \\ H_2^T P_3 & H_2^T P_4 & -\gamma I_2 \end{bmatrix} \leq 0 \quad (36)$$

which directly leads to (31) once the MFs are dropped off. The final form of the TS descriptor observer is obtained as follows: using (19), define

$$\begin{bmatrix} N_{1\alpha v} \\ N_{2\alpha v} \end{bmatrix} = P^{-T} \bar{L}_{\alpha v} = \begin{bmatrix} P_1^{-1} (L_{1\alpha v} - P_3^T P_4^{-T} L_{2\alpha v}) \\ P_4^{-T} L_{2\alpha v} \end{bmatrix}. \quad (37)$$

Then,

$$\begin{bmatrix} I & 0 \\ 0 & 0 \end{bmatrix} \begin{bmatrix} \dot{\hat{x}}^e \\ \dot{\gamma}^e \end{bmatrix} = \begin{bmatrix} 0 & I \\ A_{\alpha\hat{\beta}}^e & -E_v^e \end{bmatrix} \begin{bmatrix} \hat{x}^e \\ \gamma^e \end{bmatrix} + \begin{bmatrix} N_{1\alpha v} C^e \\ N_{2\alpha v} C^e \end{bmatrix} (x^e - \hat{x}^e) \quad (38)$$

or equivalently

$$\begin{aligned} \dot{\hat{x}}^e &= \gamma^e + N_{1\alpha v} C^e (x^e - \hat{x}^e) \\ E_v^e \gamma^e &= A_{\alpha\hat{\beta}}^e \hat{x}^e + N_{2\alpha v} C^e (x^e - \hat{x}^e) \end{aligned} \quad (39)$$

From (39), we can define $\gamma^e = \dot{\hat{x}}^e - N_{1\alpha v} C^e (x^e - \hat{x}^e)$. Thus, (39) gives

$$E_v^e (\dot{\hat{x}}^e - N_{1\alpha v} C^e (x^e - \hat{x}^e)) = A_{\alpha\hat{\beta}}^e \hat{x}^e + N_{2\alpha v} C^e (x^e - \hat{x}^e) \quad (40)$$

At last, by grouping terms, it produces the final observer form

$$E_v^e \dot{\hat{x}}^e = A_{\alpha\hat{\beta}}^e \hat{x}^e + \begin{bmatrix} E_v^e & I \end{bmatrix} P^{-T} \begin{bmatrix} L_{1\alpha v} \\ L_{2\alpha v} \end{bmatrix} (y - \hat{y}). \quad (41)$$

The proof is concluded. ■

Remark 3: Notice that the non-measured premise variable $\hat{\beta} = \dot{\hat{\theta}}$ does not appear in the observer gain, i.e. $\bar{L}_{\alpha v}$ is used instead of a more general $\bar{L}_{\alpha\hat{\beta}v}$. This is due to the way of dealing with $\hat{\beta}$ (25) that makes it “disappear” from the LMI conditions (36). Thus adding $\hat{\beta}$ in $\bar{L}_{\alpha\hat{\beta}v}$ implies adding no information as any solution of the polytope considered on $\hat{\beta}$, i.e. either $\bar{L}_{\alpha 1v}$ or $\bar{L}_{\alpha 2v}$, or $0.5(\bar{L}_{\alpha 1v} + \bar{L}_{\alpha 2v})$ will be a solution of the problem.

4. SIMULATIONS AND DISCUSSIONS

4.1 Protocol

In order to get closer to the real-time protocol, which is the next step of the study, the following simulation is considered through this work. A generalized stabilized model is considered including the continuous H2AT model (1) and its stabilization via control law (3) considering a delay $\tau(t) = 60\text{ms} \pm 10$. This generalized model is a “black box” from which the only

measurements are $\begin{bmatrix} x_r(t) \\ \theta(t) \end{bmatrix}$ and the unknown input observer has to reconstruct the unknown input $F(t - \tau(t))$ drawn with a

“?” on Fig. 4. Of course, the simulation process can validate the entire procedure as we can exhibit the unknown input error $F(t - \tau(t)) - \hat{F}(t - \tau(t))$.

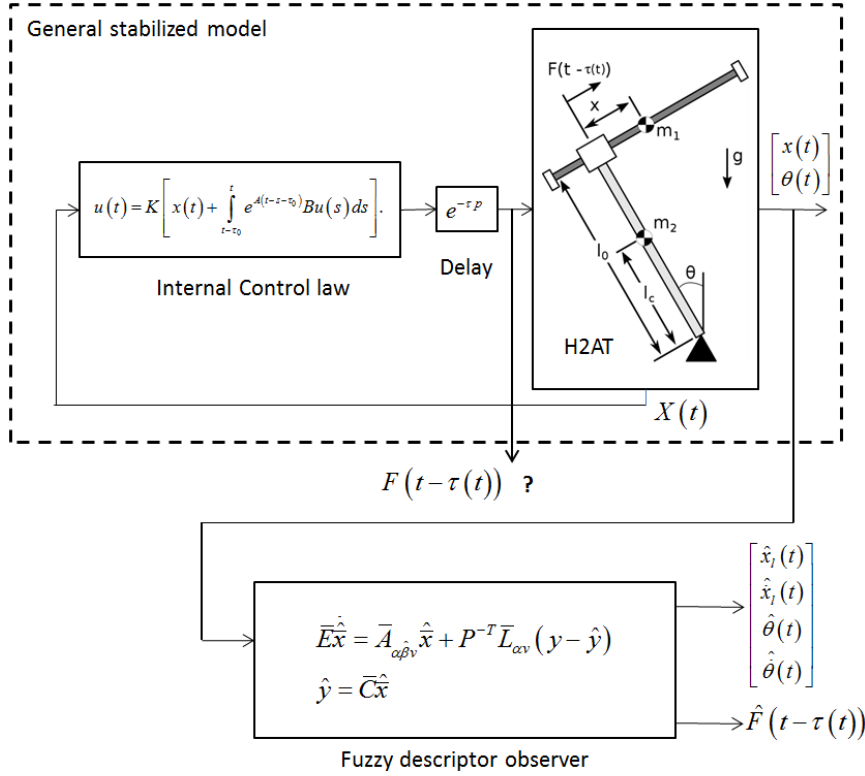

Fig. 4. Simulation procedure

4.2 Simulation results

In this section, simulation results are presented, that is, the TS descriptor model (15) under the control law (3) with the same gains as presented before and the observer (19) in order to estimate both the state vector and the unknown input $F(t - \tau(t))$. When implementing conditions in Theorem 1 together with a decay rate performance, the choice of $\lambda = 60$ exhibits a good compromise. Some of the matrices issued from the LMI constraint problem (30) are given thereafter.

$$L_{11}^{(1)} = 10^6 * \begin{bmatrix} 12.54 & 8.584 \\ -0.001 & 0.060 \\ 8.584 & 20.14 \\ 0.028 & 0.044 \\ 0.004 & 0.004 \\ 0.000 & 0.000 \end{bmatrix}, \quad L_{11}^{(2)} = 10^4 * \begin{bmatrix} 8.263 & 10.52 \\ -1.524 & -5.828 \\ 7.980 & 16.92 \\ -0.796 & 2.233 \\ -0.008 & -0.006 \\ -0.000 & -0.000 \end{bmatrix}$$

$$P_1 = \begin{bmatrix} 4.18e+5 & * & * & * & * & * \\ -5.60e+3 & 1.40e+2 & * & * & * & * \\ 2.86e+5 & -2.00e+3 & 6.71e+5 & * & * & * \\ -2.97e+3 & 8.24e+1 & -7.63e+3 & 1.73e+2 & * & * \\ 1.96e+1 & -9.00e-1 & 2.47e+1 & -1.12e+0 & 1.15e-2 & * \\ -2.40e-1 & 1.68e-2 & -3.61e-1 & 2.20e-2 & -2.77e-4 & 7.80e-6 \end{bmatrix}$$

To begin with, the same trial as presented before is used. The maximal error for this trial for $\theta(t) - \hat{\theta}(t)$ is less than 0.02% and for $x_i(t) - \hat{x}_i(t)$ 0.04%. Fig. 5 left presents the error signal in % for $\dot{\theta}(t) - \hat{\dot{\theta}}(t)$ where a pike at 6% can be observed at the beginning due to the initial conditions. Fig. 5 right shows the very good estimation of the unknown input using the TS unknown observer with the non-measurable premise $\dot{\theta}(t)$.

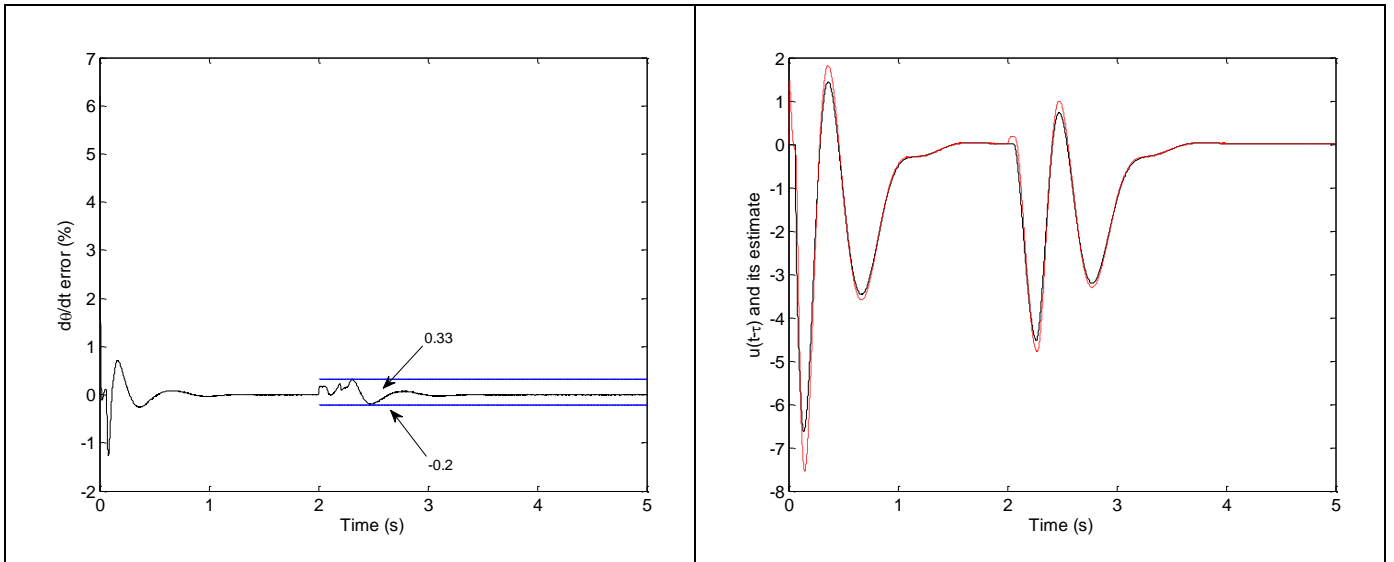

Fig. 5. Stabilization of the model (2) with control law (3)

A different trial is presented. First, initial conditions chosen are $x(0) = [0 \quad -0.02 \quad 0 \quad 0.01]^T$ that corresponds to the two first seconds. Second, a disturbance showed Fig. 6 is applied from $2s$ to $4s$, representing a sinus with a $10rad/s$ pulsation, which is the kind of accelerations used in training ergometers for rehabilitation (Bjerkefors et al. 2007). The state response signals for both the nonlinear model (2) and the observer (41) are given in Fig. 7 as well as the unknown input estimation result in Fig. 8.

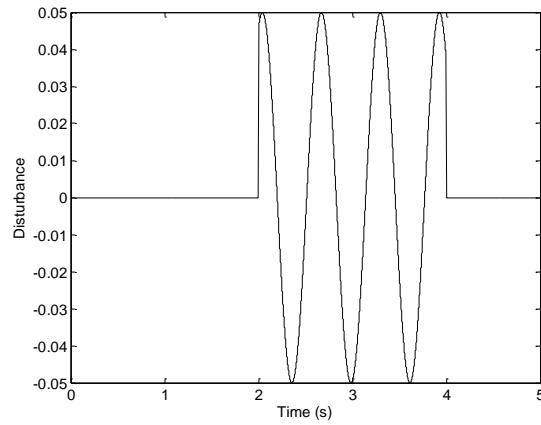

Fig. 6 Disturbance signal applied on the acceleration $\ddot{\theta}(t)$

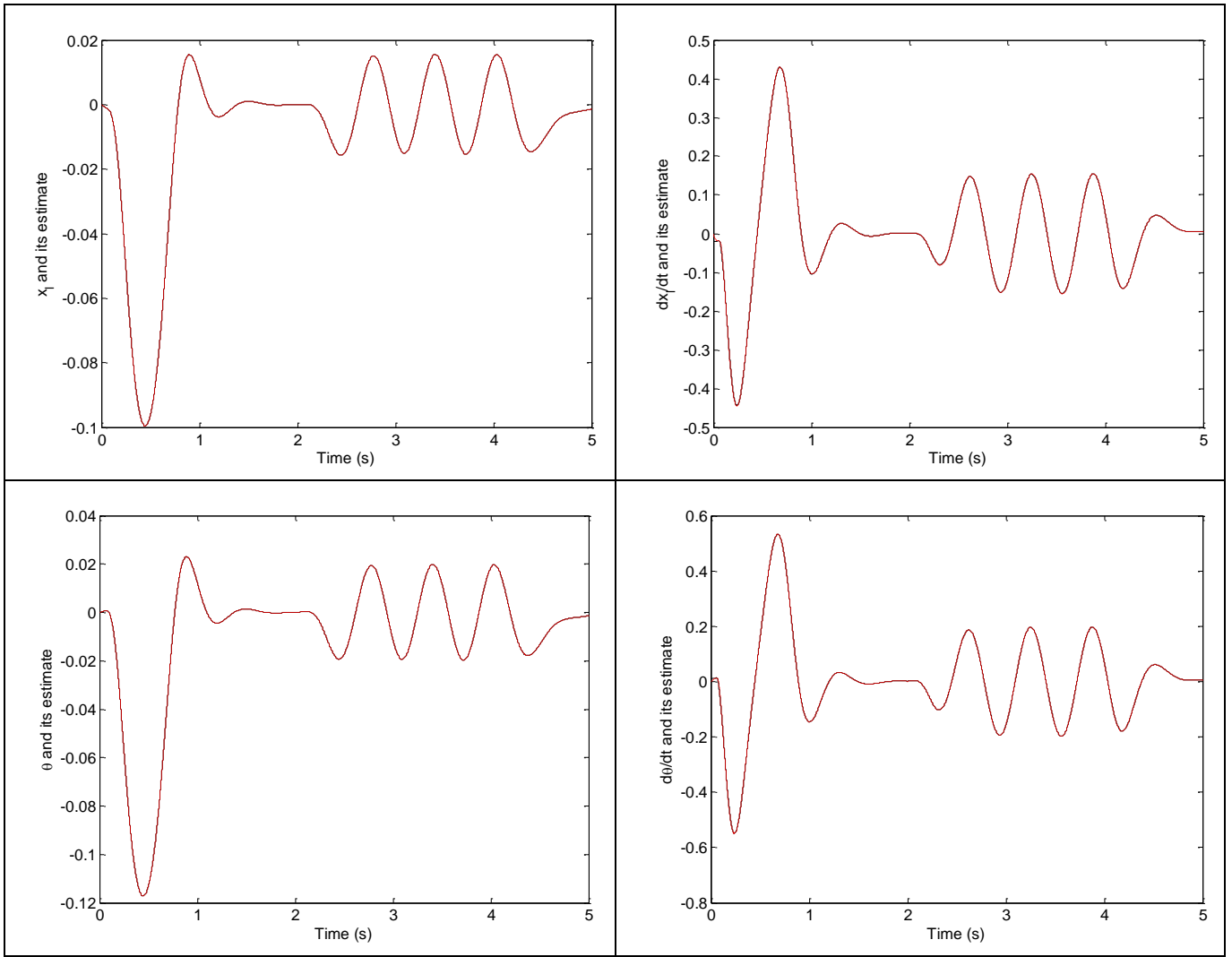

Fig. 7 the nonlinear model state response (black) and the TS-descriptor state responses (red), from top left to bottom right:

$$(x_1(t), \hat{x}_1(t)), (\dot{x}_1(t), \hat{\dot{x}}_1(t)), (\theta(t), \hat{\theta}(t)) \text{ and } (\dot{\theta}(t), \hat{\dot{\theta}}(t))$$

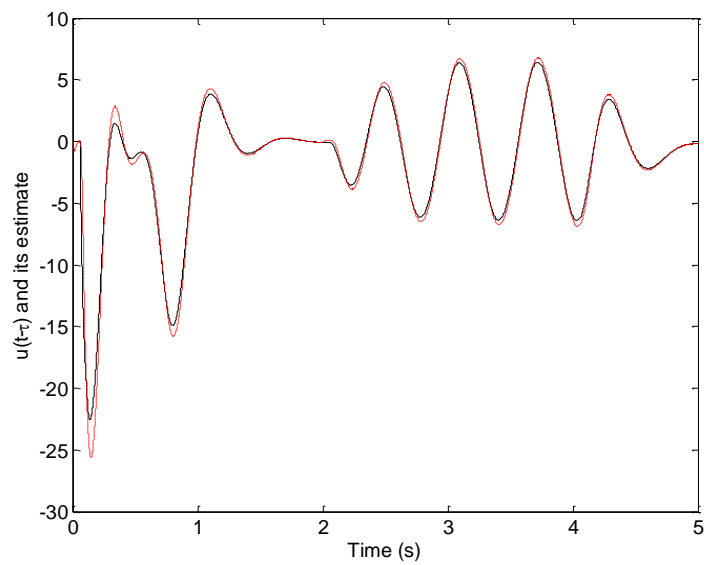

Fig. 8 The unknown input from the nonlinear closed loop model (black) and its estimation (red)

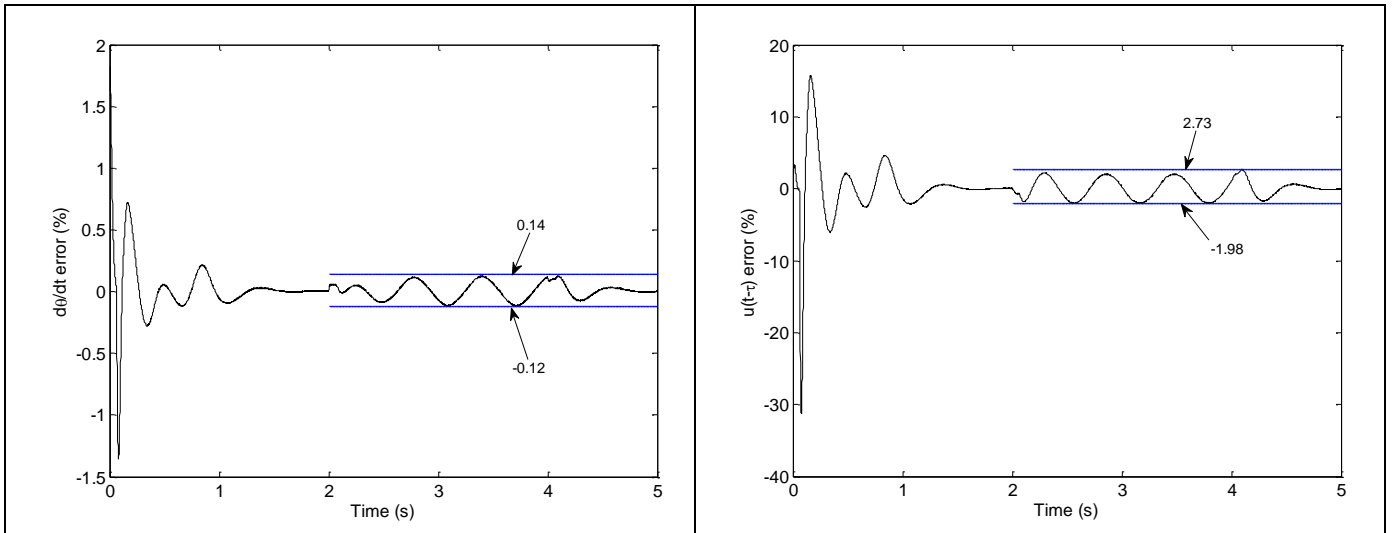

Fig. 9 Observation relative error in %

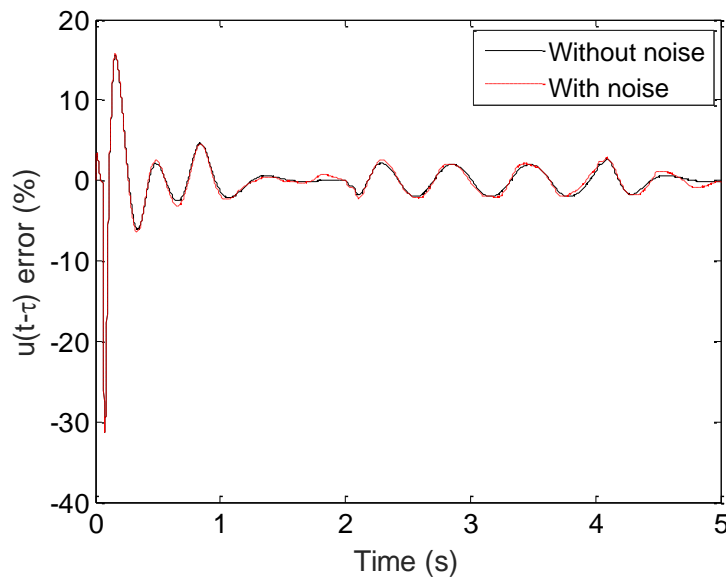

Fig. 10 The unknown input estimation error with and without measurement noise

Notice that the errors on the state are rather small: for the two main important variables, i.e. the non-measured premise variable $\hat{\theta}(t)$ and the unknown input $F(t-\tau(t))$ Fig. 9 presents the relative error in percent. A first remark that can be done is the excellent performance for the non-measurable premise variable $\hat{\theta}(t)$, i.e. less than 1.5% error for the transient and less than 0.14% for the disturbance, Fig. 9 left. This result is due to the robust scheme presented in (26). This excellent performance therefore explains that the unknown input has as well a very accurate estimation, i.e. around 20% according to initial conditions and due to the delay on the control and less than 2.8% during and after the perturbation on the acceleration, Fig. 9 right. The observer sensitivity to measurement noise was also tested by adding a filtered noise to the output $y(t)$. The noise was created as a white noise with a 5mm RMS then filtered through a low pass four-order Butterworth filter with a cutoff frequency of 10Hz (Gagnon et al. 2008). The results presented Fig. 10 exhibits a nice behavior.

5. CONCLUSION

The main objective of the work was to study the sitting of complete thoracic SCI people. To this end, a variation of inverted pendulum has been formulated, then a control law has been designed including a time-varying input delay in order to mimic a

human behavior; finally a fuzzy T–S unknown-inputs-observer in descriptor form was designed to estimate the generated force stabilizing the system. This method applied on descriptor has been put under LMI conditions in the recent works of (Guerra et al. 2015) and (Estrada-Manzo et al. 2015). Although the H2AT model is a simplification of the upper body joints, its use combined with experimental data will allow us to compare different strategies of stabilization for persons with SCI when submitted to perturbations.

Several assumptions have been made in order to cope with this first approach; we consider a perfect lumbar joint without passive resistance to flexion and the delay was represented as a continuous time carrying input delay. The first hypothesis has often been used in biomechanics for the ankle (Peterka 2000) or the trunk (Vette et al. 2010) but it is known that flexion and extension of the trunk lead to resistive forces created by passive physiological phenomenon (Cholewicki et al. 1999; Panjabi 1992; Preuss and Fung 2008). For the second assumption, the neural delay depends on the length of the neural path between the sensor and the muscles, the time that the central nervous system need to process the signal and also the time for a muscle to generate force once it is excited (Li et al. 2012). It is known that delays often bring instability to mechanical system; however, it has been shown that attentional demands (hence longer processing delay) associated with postural control vary, depending on the complexity of the task and the type of second task being performed (Woollacott and Shumway-Cook 2002). Future research are directed to 1. Experimental validation of the observer, 2. Geometrical adaptation of the model based on the experimental results and 3. Increasing of the model complexity in order to describe the stability of the upper body as the combination of three subsystems: active (e.g. joint voluntary activation), passive (e.g. viscoelasticity of the joint) and neural (e.g. activation delay...).

The Unknown Input Observer technique is very seldom used in biomechanics but its advantages are to be emphasized. We can estimate the force in our model without having to compute the velocities and accelerations of the segments, which is one of the drawbacks of inverse dynamics: the classical method in biomechanics, which reports successively the measurement errors at each new joint.

ACKNOWLEDGEMENTS

This work is supported by the French Ministry of Higher Education and Research, the National Center for Scientific Research (CNRS), the Nord-Pas-de-Calais Region, the postdoctoral-CONACYT fellowship for CV 366627, Zodiac Seat France and Direction Générale de l'Aviation Civile (project n°2014 93 0818). The authors gratefully acknowledge the support of these institutions.

REFERENCES

- Bjerkefors, A., Carpenter, M. G., and Thorstensson, A. (2007). "Dynamic trunk stability is improved in paraplegics following kayak ergometer training." *Scandinavian Journal of Medicine & Science in Sports*, 17(6), 672–679.
- Blandeau, M., Estrada-Manzo, V., Guerra, T. M., Pudlo, P., and Gabrielli, F. (2016a). "Unknown Input Observer for Understanding Sitting Control of Persons with Spine Cord Injury." *IFAC-PapersOnLine*, 4th IFAC Conference on Intelligent Control and Automation Sciences/ICONS 2016/Reims, France, 1–3 June 2016, 49(5), 175–181.
- Blandeau, M., Guerra, T. M., Pudlo, P., Gabrielli, F., and Estrada-Manzo, V. (2016b). "How a person with spinal cord injury controls a sitting situation Unknown input observer and delayed feedback control with time-varying input delay." *2016 IEEE International Conference on Fuzzy Systems (FUZZ-IEEE)*, 2349–2356.
- Boyd, S., Ghaoui, L. E., Feron, E., and Balakrishnan, V. (1994). *Linear Matrix Inequalities in System and Control Theory*. Society for Industrial and Applied Mathematics.
- Cholewicki, J., Juluru, K., and McGill, S. M. (1999). "Intra-abdominal pressure mechanism for stabilizing the lumbar spine." *Journal of biomechanics*, 32(1), 13–17.
- Crisco, J. J., Panjabi, M. M., Yamamoto, I., and Oxland, T. R. (1992). "Euler stability of the human ligamentous lumbar spine. Part II: Experiment." *Clinical Biomechanics*, 7(1), 27–32.
- Dumas, R., Chèze, L., and Verriest, J.-P. (2007). "Adjustments to McConville et al. and Young et al. body segment inertial parameters." *Journal of Biomechanics*, 40(3), 543–553.
- Estrada-Manzo, V., Lendek, Z., and Guerra, T. M. (2015). "Unknown input estimation of nonlinear descriptor systems via LMIs and Takagi-Sugeno models." *54th IEEE Conference on Decision and Control (CDC)*, Osaka, Japan, 6349–6354.
- Gagnon, D., Nadeau, S., Noreau, L., Dehail, P., and Pottie, F. (2008). "Comparison of peak shoulder and elbow mechanical loads during weight-relief lifts and sitting pivot transfers among manual wheelchair users with spinal cord injury." *The Journal of Rehabilitation Research and Development*, 45(6), 863–874.
- Georges, D., Besancon, G., Benayache, Z., and Witrant, E. (2007). "A nonlinear state feedback design for nonlinear systems with input delay." *Control Conference (ECC), 2007 European*, IEEE, 915–921.
- Grangeon, M., Gagnon, D., Gauthier, C., Jacquemin, G., Masani, K., and Popovic, M. R. (2012). "Effects of upper limb positions and weight support roles on quasi-static seated postural stability in individuals with spinal cord injury." *Gait & posture*, 36(3), 572–579.

- Guelton, K., Delprat, S., and Guerra, T. M. (2008). "An alternative to inverse dynamics joint torques estimation in human stance based on a Takagi–Sugeno unknown-inputs observer in the descriptor form." *Control Engineering Practice*, 16(12), 1414–1426.
- Guerra, T. M., Estrada-Manzo, V., and Lendek, Z. (2015). "Observer design for Takagi–Sugeno descriptor models: An LMI approach." *Automatica*, 52, 154–159.
- Guerra, T. M., Kruszewski, A., Vermeiren, L., and Tirmant, H. (2006). "Conditions of output stabilization for nonlinear models in the Takagi–Sugeno's form." *Fuzzy Sets and Systems*, Fuzzy Concepts Applied to Food Control Quality Control, 157(9), 1248–1259.
- Ichalal, D., Mammari, S., and Ragot, J. (2016). "Auxiliary dynamics for observer design of nonlinear TS systems with unmeasurable premise variables." *IFAC-PapersOnLine*, 4th IFAC Conference on Intelligent Control and Automation Sciences/ICONS 2016/Reims, France, 1–3 June 2016, 49(5), 1–6.
- Janssen-Potten, Y. J., Seelen, H. A., Drukker, J., Huson, T., and Drost, M. R. (2001). "The effect of seat tilting on pelvic position, balance control, and compensatory postural muscle use in paraplegic subjects." *Archives of Physical Medicine and Rehabilitation*, 82(10), 1393–1402.
- Jones, L. M., Legge, M., and Goulding, A. (2003). "Healthy body mass index values often underestimate body fat in men with spinal cord injury." *Archives of Physical Medicine and Rehabilitation*, 84(7), 1068–1071.
- Kapandji, A. I. (2005). *Anatomie fonctionnelle I : Membres supérieurs. Physiologie de l'appareil locomoteur*. Maloine.
- Lewis, F. L., Dawson, D. M., and Abdallah, C. T. (2003). *Robot Manipulator Control: Theory and Practice*. CRC Press.
- Li, Y., Levine, W. S., and Loeb, G. E. (2012). "A Two-Joint Human Posture Control Model With Realistic Neural Delays." *IEEE Transactions on Neural Systems and Rehabilitation Engineering*, 20(5), 738–748.
- Ohtake, H., Tanaka, K., and Wang, H. O. (2001). "Fuzzy modeling via sector nonlinearity concept." *IFSA World Congress and 20th NAFIPS International Conference, 2001. Joint 9th*, 127–132.
- Panjabi, M. M. (1992). "The stabilizing system of the spine. Part I. Function, dysfunction, adaptation, and enhancement." *Journal of Spinal Disorders*, 5(4), 383–389; discussion 397.
- Peterka, R. J. (2000). "Postural control model interpretation of stabilogram diffusion analysis." *Biological cybernetics*, 82(4), 335–343.
- Preuss, R., and Fung, J. (2008). "Musculature and biomechanics of the trunk in the maintenance of upright posture." *Journal of Electromyography and Kinesiology*, 18(5), 815–828.
- Reeves, N. P., Cholewicki, J., and Narendra, K. S. (2009). "Effects of reflex delays on postural control during unstable seated balance." *Journal of Biomechanics*, 42(2), 164–170.
- Reeves, P., Narendra, K. S., and Cholewicki, J. (2007). "Spine stability: The six blind men and the elephant." *Clinical Biomechanics*, 22(3), 266–274.
- Silfies, S. P., Cholewicki, J., and Radebold, A. (2003). "The effects of visual input on postural control of the lumbar spine in unstable sitting." *Human Movement Science*, 22(3), 237–252.
- Tanaka, M. L., and Granata, K. P. (2007). "Methods & nonlinear analysis for measuring torso stability." *ASCE 18th Engineering Mechanics Division Conference Blacksburg, VA*, 3–6.
- Taniguchi, T., Tanaka, K., Yamafuji, K., and Wang, H. O. (1999). "Fuzzy descriptor systems: stability analysis and design via LMIs." *American Control Conference, 1999. Proceedings of the 1999*, IEEE, 1827–1831.
- Vette, A. H., Masani, K., Sin, V., and Popovic, M. R. (2010). "Posturographic measures in healthy young adults during quiet sitting in comparison with quiet standing." *Medical Engineering & Physics*, 32(1), 32–38.
- Woollacott, M., and Shumway-Cook, A. (2002). "Attention and the control of posture and gait: a review of an emerging area of research." *Gait & Posture*, 16(1), 1–14.
- Yue, D., and Han, Q.-L. (2005). "Delayed feedback control of uncertain systems with time-varying input delay." *Automatica*, 41(2), 233–240.