



HAL
open science

Comparison Based on Exergetic Analyses of Two Hot Air Engines: A Gamma Type Stirling Engine and an Open Joule Cycle Ericsson Engine

Houda Hachem, Marie Creyx, Ramla Gheith, Eric Delacourt, Céline Morin,
Fethi Aloui, Sassi Ben Nasrallah

► **To cite this version:**

Houda Hachem, Marie Creyx, Ramla Gheith, Eric Delacourt, Céline Morin, et al.. Comparison Based on Exergetic Analyses of Two Hot Air Engines: A Gamma Type Stirling Engine and an Open Joule Cycle Ericsson Engine. *Entropy*, 2015, 17 (11), pp.7331-7348. 10.3390/e17117331 . hal-03448497

HAL Id: hal-03448497

<https://uphf.hal.science/hal-03448497v1>

Submitted on 14 Apr 2022

HAL is a multi-disciplinary open access archive for the deposit and dissemination of scientific research documents, whether they are published or not. The documents may come from teaching and research institutions in France or abroad, or from public or private research centers.

L'archive ouverte pluridisciplinaire **HAL**, est destinée au dépôt et à la diffusion de documents scientifiques de niveau recherche, publiés ou non, émanant des établissements d'enseignement et de recherche français ou étrangers, des laboratoires publics ou privés.



Distributed under a Creative Commons Attribution 4.0 International License

Article

Comparison Based on Exergetic Analyses of Two Hot Air Engines: A Gamma Type Stirling Engine and an Open Joule Cycle Ericsson Engine

Houda Hachem ^{1,*}, Marie Creyx ², Ramla Gheith ¹, Eric Delacourt ², Céline Morin ², Fethi Aloui ² and Sassi Ben Nasrallah ¹

¹ LESTE, Ecole Nationale d'Ingénieurs de Monastir, Université de Monastir, Rue Ibn El Jassar, Monastir 5019, Tunisia; E-Mails: ramla2gheith@yahoo.fr (R.G.); sassi.bennasrallah@enim.rnu.tn (S.B.N.)

² LAMIH, CNRS UMR 8201, Université de Valenciennes et du Hainaut-Cambrésis, Le Mont Houy, 59313 Valenciennes cedex 9, France; E-Mails: marie.creyx@univ-valenciennes.fr (M.C.); eric.delacourt@univ-valenciennes.fr (E.D.); celine.morin@univ-valenciennes.fr (C.M.); fethi.aloui@univ-valenciennes.fr (F.A.)

* Author to whom correspondence should be addressed; E-Mail: houdahachem@yahoo.fr; Tel.: +216-73-500-511; Fax: +216-73-500-514.

Academic Editor: Kevin H. Knuth

Received: 9 July 2015 / Accepted: 20 October 2015 / Published: 28 October 2015

Abstract: In this paper, a comparison of exergetic models between two hot air engines (a Gamma type Stirling prototype having a maximum output mechanical power of 500 W and an Ericsson hot air engine with a maximum power of 300 W) is made. Referring to previous energetic analyses, exergetic models are set up in order to quantify the exergy destruction and efficiencies in each type of engine. The repartition of the exergy fluxes in each part of the two engines are determined and represented in Sankey diagrams, using dimensionless exergy fluxes. The results show a similar proportion in both engines of destroyed exergy compared to the exergy flux from the hot source. The compression cylinders generate the highest exergy destruction, whereas the expansion cylinders generate the lowest one. The regenerator of the Stirling engine increases the exergy resource at the inlet of the expansion cylinder, which might be also set up in the Ericsson engine, using a preheater between the exhaust air and the compressed air transferred to the hot heat exchanger.

Keywords: exergy analysis; exergy fluxes; exergy destruction; Stirling and Ericsson hot air engines

1. Introduction

The micro-combined heat and electrical power system (micro-CHP) is an emerging technology presenting a high global efficiency, which allows primary energy savings compared with a separated production of heat and electrical power. The devices dedicated to the conversion of energy resource into mechanical or electrical energy are various: internal combustion engines, micro-gas turbines, organic Rankine cycle (ORC) turbines, hot air engines (Stirling and Ericsson), fuel cells and thermoelectric generators [1]. Among them, the external heat supply systems are adapted to various energy resources (combustion, solar or geothermal energy, high temperature exhaust gases, waste heat from industrial processes). In particular, the Stirling and the Ericsson hot air engines present high efficiencies (maximum theoretical thermodynamic efficiency of about 45%) for the power levels of the micro-cogeneration (under 50 kW) [2]. They are noiseless and not harmful to the environment (no direct pollutant emission by these engines), can operate with various sources of energy (especially renewable energy and coupled to cogeneration systems) and require a low maintenance.

The Stirling engine works on a closed cycle requiring a cold source heat exchanger, whereas the Ericsson engine works on an open cycle (without a cold source heat exchanger, the cold source being the ambient atmosphere) [1]. The pressure level of the working fluid can reach higher values in the Stirling engine, e.g., until 200 bar in [3], when the pressure of the open cycle Ericsson engine remains under 10 bar to ensure high performances (in particular high specific work and indicated mean pressure) [1]. The heat exchanger on hot source side faces strong surface-volume constraints in the Stirling engine [4] compared to the Ericsson engine. The Ericsson engine requires valves for the working fluid circulation, contrary to the Stirling engine. Several configurations of Stirling engines can be found namely Alpha, Beta and Gamma. They follow the same thermodynamic cycle (Stirling cycle with two isothermal and two isochoric transformations) but present different mechanical designs. The Alpha configuration has twin power pistons separated in two cylinders. For the Beta configuration, the displacer and the power piston are incorporated in the same cylinder. The Gamma configuration uses two separate cylinders, one for the displacer and the other for the power piston [5]. In this study, a Stirling engine with Gamma configuration having air as working fluid and a stainless steel regenerator with 85% porosity is investigated. In the Ericsson engines, the cylinder arrangements are not classified, due to the small number of models or experimental set up built up-to-date [6–11]. A preheater can be added between the working fluid at the exhaust of the engine and the working fluid at the inlet of the hot source heat exchanger to recover thermal energy [1].

The Stirling and the Ericsson engines are mainly studied on the basis of energetic analyses, e.g., in [12–14] for Stirling engines or in [15] for Ericsson engines. Some studies deal with the exergetic analysis of these engines. Martaj *et al.* [16,17] investigated energy, entropy and exergy balances for each main element of a Stirling engine and for the complete engine. They presented the irreversibilities due to imperfect regeneration and temperature differences between gas and wall in the hot and cold

exchangers with an experimental validation. Their simulation shows the optimum operating conditions of the Stirling engine (highest efficiencies, smallest entropy production and minimum operating costs). Hachem *et al.* [18] set up an experimental energy and exergy assessment of a Beta type Stirling engine. The results show that the thermal insulation improves slightly the overall exergy efficiency of the engine and that the exergy destruction increases with hot source temperature. Saneipour *et al.* [19–21] studied experimentally a low temperature heat engine (temperature difference below 100 K, for a maximum temperature of about 393 K), called a Marnoch heat engine (MHE). They found that the exergy efficiency of the MHE goes up to 17%. Bonnet *et al.* [15] applied an exergy balance on an Ericsson engine with regenerator associated to a natural gas combustion chamber and deduced the exergy flux repartition in the system, the exergy destruction and the exergetic efficiencies of the components. Some studies show a comparison of the Stirling and Ericsson engines, mainly based on a technological point of view, e.g. in [1,22]. To the knowledge of the authors, the comparison of the Stirling and Ericsson engines considering an exergetic point of view has not been performed yet.

This study is focusing on a comparison between exergetic analyses of a Gamma type Stirling engine and an open Joule cycle Ericsson engine. The first part describes the configurations of both engines studied. The modelling of the engines is then presented with the energy and exergy balances and with the energetic and exergetic performances. The exergy flux repartition and the exergetic performances of the engines are finally discussed considering specific working conditions for each engine.

2. Configurations of the Gamma Type Stirling Engine and the Open Cycle Ericsson Engines

2.1. Geometries and Working Conditions

A Gamma type Stirling engine will be investigated in this study. It uses air as working fluid and can deliver a maximum output mechanical power of about 500 W. Its maximum rotation speed is around 600 rpm when the maximum working pressure is about 10 bar. This engine is mainly composed of a compression cylinder (C), an expansion cylinder (E) and three heat exchangers (heater, regenerator, cooler). The regenerator (R) is a porous medium (*i.e.*, made of stainless steel with 85% porosity). In the real engine, the cooler (K) acts as a cold source heat exchanger formed by an open water circuit and the heater consists of 20 tubes in order to increase the exchange surface between the working gas and the hot source (H). In the modelling assumptions, the hot source of the Stirling engine is the expansion cylinder wall and the cold source is the compression cylinder wall (*cf.* Figure 1a). The geometric properties of this Stirling engine are presented in previous studies of Gheith *et al.* [23–26], with some experimental investigations. In particular, the influence of initial filling pressure, engine speed, cooling water flow rates and heating temperature on the engine performances (brake power and efficiency) has been highlighted. More recently, Hachem *et al.* [27] presented a global energetic modelling of the same Stirling engine. They showed that the engine rotation speed have an optimum value that guarantees the best Stirling engine performances. For low rotation speeds, the brake power increased with rotation speed, whereas for high rotation speeds, the brake power decreases when the rotation speed increases. The increase of initial filling pressure leads to an increase of working fluid mass. The increase of hot end temperature leads to an increase of the thermal exchanged energy. These two phenomena cause the

increase of the engine brake power. The authors demonstrated that engine brake power is also sensitive to its heat exchanger efficiency. The engine regenerator is the most influencing component.

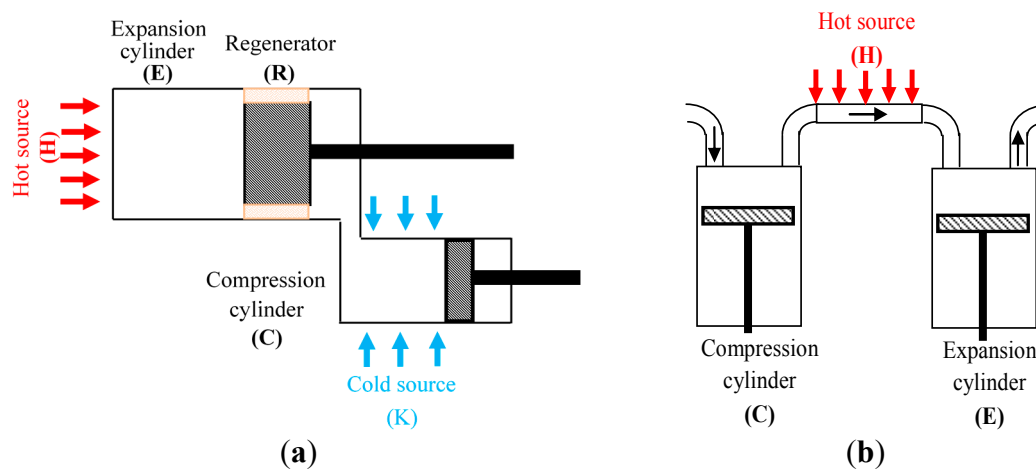

Figure 1. Configurations of the Gamma type Stirling engine (a) and the open Joule cycle Ericsson engine (b).

The Ericsson engine studied, composed of a compression cylinder (C), a tubular heat exchanger (H) and an expansion cylinder (E), is presented in Figure 1b. The working fluid is air which follows a Joule cycle in the compression and expansion cylinders. The maximum pressure is 8 bar. The maximum mechanical power reaches 300 W for a rotation speed under 1400 rpm. More details on the technology of the Ericsson engine studied were given in [28]. Creyx *et al.* [1,28] numerically studied the performances of this Ericsson engine with energetic models in a steady-state [1] or considering dynamic phenomena [28].

Table 1 gathers several comparative elements of the configurations of Stirling and Ericsson engines taken into account in the exergetic analyses, showing similarities, such as the use of separate cylinders for the compression and expansion phases of air. In the modelling, only the compression cylinder, the expansion cylinder and the regenerator for the Stirling engine are considered. The swept volumes in the cylinders are different for each engine chosen. This limits the relevance of a direct comparison of the performances. Here, the main objective is to determine the repartition of exergy fluxes in both engines in order to identify the zones of exergy destruction and compare the role of the engine components in the processing of the exergy resource into mechanical power.

Table 1. Technological comparison between Stirling and Ericsson engines.

Engine	Stirling	Ericsson
Thermodynamic cycle	closed	open
Number of cycles per crankshaft revolution	1	1
Working fluid	air	air
Expansion cylinder swept volume	520 cm ³	160 cm ³
Compression cylinder swept volume	360 cm ³	220 cm ³
Hot source	expansion cylinder wall	internal tube wall
Cold source	compression cylinder wall	atmosphere
Regenerator	stainless steel with 85% porosity	-

2.2. Thermodynamic Cycles

The Stirling engine works with a closed Stirling cycle, with isothermal compression and expansion and isochoric compression and expansion (cf. indicated diagram of Figure 2a), while the Ericsson engine requires two open Joule cycles with adiabatic compression and expansion and with two isobaric displacements (one Joule cycle in each cylinder): a compression cycle (cf. indicated diagram of Figure 2b1) and an expansion cycle (cf. indicated diagram of Figure 2b2). The Stirling engine includes a cold source heat exchanger, due to the functioning with a closed cycle, and a regenerator that transfers a part of the residual heat from the air after expansion to the compressed air.

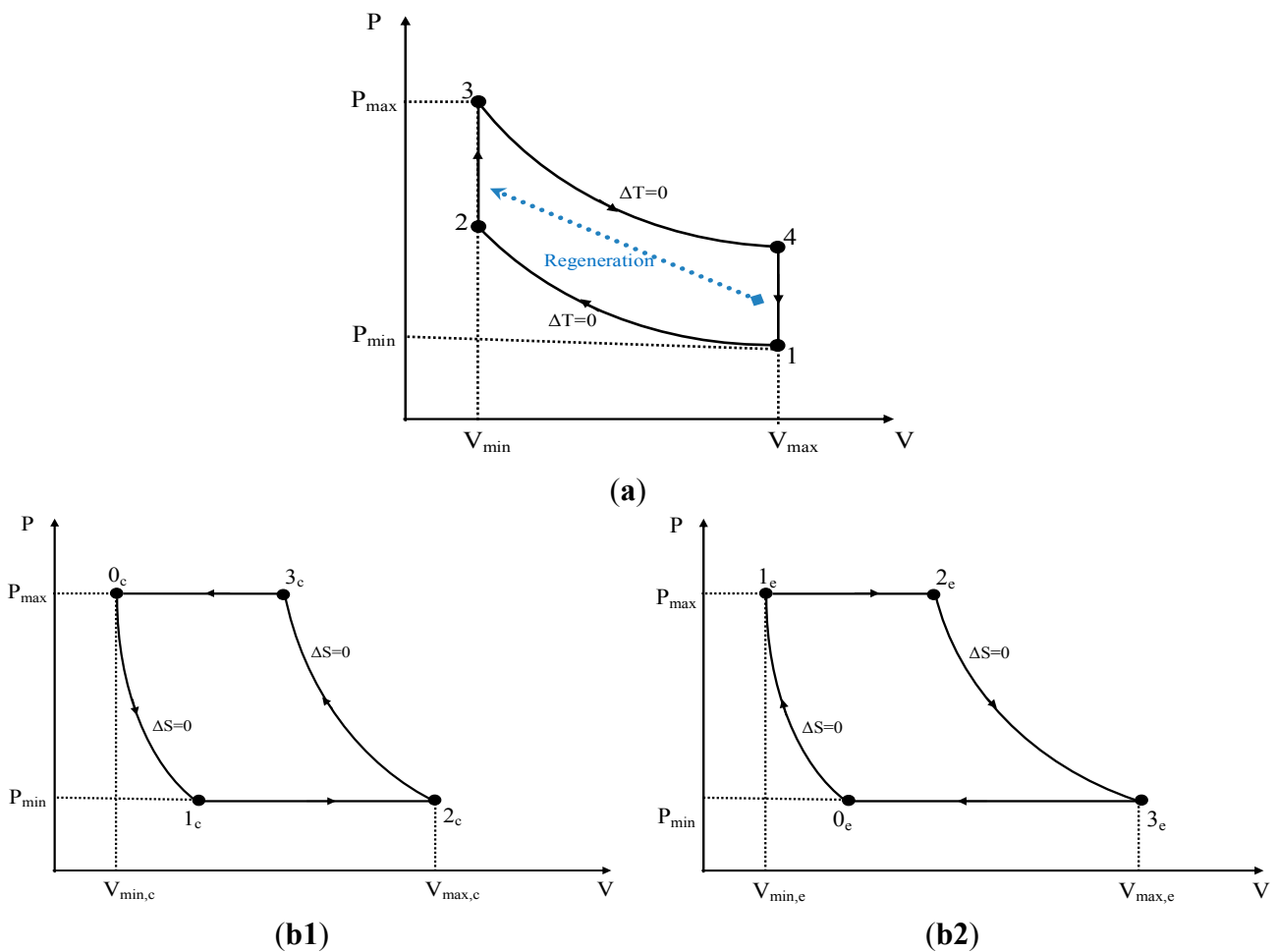

Figure 2. Theoretical Stirling cycle (a) (Stirling engine) and theoretical Joule compression (b1) and expansion (b2) cycles (Ericsson engine).

3. Modelling of the Hot Air Engines

3.1. Energy Balance on the Hot Air Engines

When considering the control volume presented in Figure 3, with entering energy fluxes assumed positive, the energy balance equation on the hot air engine is written as follows:

$$\frac{dU}{dt} = \dot{Q} + \dot{W} + \dot{H}_{in} - \dot{H}_{out} \tag{1}$$

where dU/dt is the internal energy variation depending on time in the control volume, \dot{Q} is the heat flux entering the control volume, \dot{W} is the indicated power, $\dot{H}_{in} - \dot{H}_{out}$ is the resulting total enthalpy flux inside the control volume.

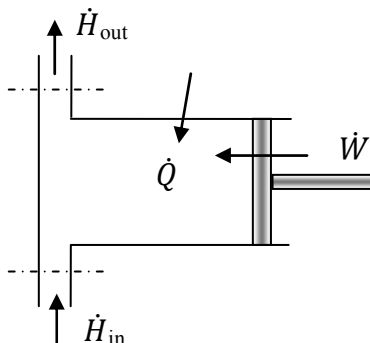

Figure 3. Control volume.

The hypotheses of the energetic models described by Hachem *et al.* [27] for the Stirling engine and by Creyx *et al.* [28] for the Ericsson engine are assumed. In this modelling, the working air is considered perfect. The potential and kinetic energies in the total enthalpy are neglected. The mechanical systems are not considered in the models. Heat transfers with external environment are supposed at constant hot temperature T_h for each engine and at constant cold temperature T_k for the Stirling engine. The hot and cold temperature heat exchangers are considered perfect (losses inside heater and cooler are supposed negligible). For the Stirling engine, the heat is transferred to the working fluid by forced convection between the walls of the compression and expansion cylinders (respectively at temperatures T_{wc} and T_{we}) and the average air temperature inside the cylinders (respectively at temperatures T_c and T_e). The exchanges of energy flux in both engines are presented in Figure 4.

The heat fluxes respectively from hot and cold heat exchangers in the Stirling engine cylinder walls (cf. Figure 1a) are calculated as follows:

$$\dot{Q}_{h,Stirling} = \dot{m} r T_h \ln(x) \quad (2)$$

$$\dot{Q}_{k,Stirling} = \dot{m} r T_k \ln(x) \quad (3)$$

where $x = V_{max} / V_{min}$ is the volume ratio during the regenerative process, r is the specific gas constant, \dot{m} is the mass flow rate of the working air. For the Stirling engine, the mass flow rate is defined as the mass per cycle entering the expansion cylinder (sum of positive instantaneous values) multiplied by the rotation frequency (with one cycle performed per crankshaft turn). This definition facilitates the comparison with the open Joule cycle Ericsson engine.

The heat transfer rate \dot{Q}_h from the external hot heat exchanger of the Ericsson engine (cf. Figure 1) is evaluated from the total enthalpy variation between the inlet of the expansion cylinder and the outlet of the compression cylinder:

$$\dot{Q}_{h,Ericsson} = \dot{H}_{in,e} - \dot{H}_{out,c} \quad (4)$$

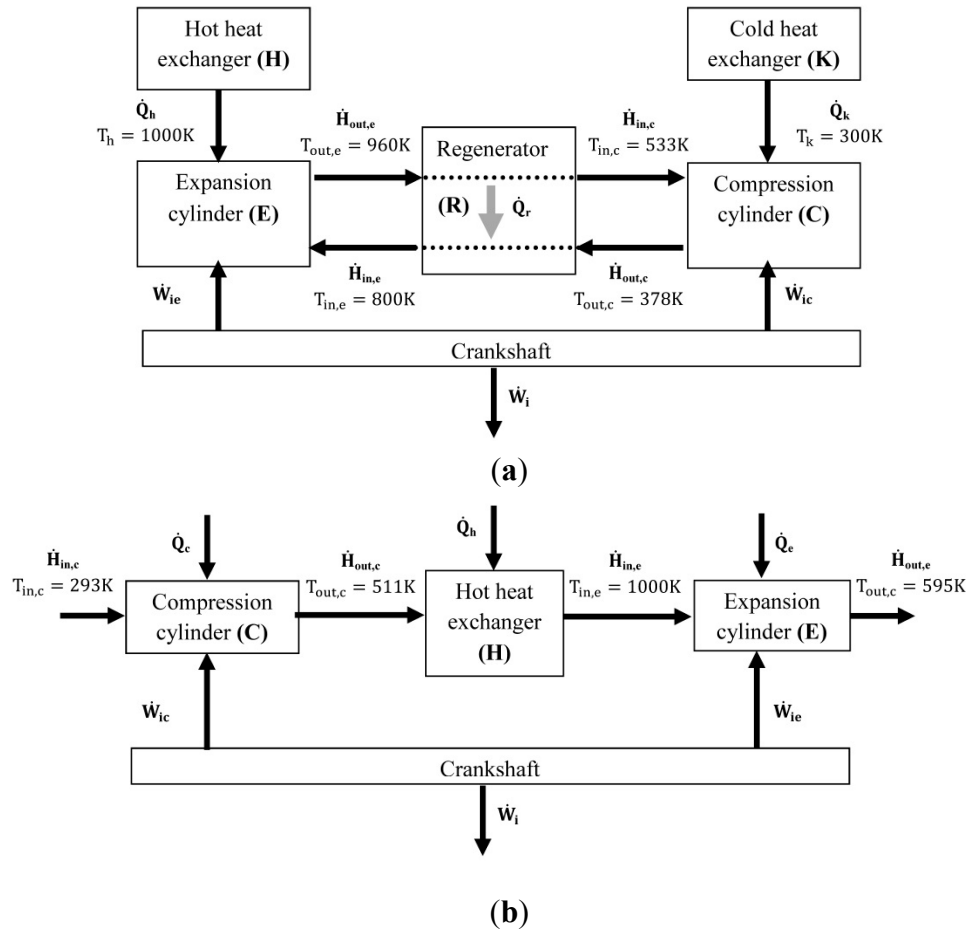

Figure 4. Total enthalpy fluxes and power exchanges in the Stirling (a) and Ericsson (b) engines.

3.2. Exergy Balance on the Hot Air Engines

The standard exergy balance equation in the control volume (*cf.* Figure 3) can be written as follows [29,30]:

$$\dot{E}x_{\dot{H}_{in}} - \dot{E}x_{\dot{H}_{out}} + \dot{E}x_{\dot{W}} + \dot{E}x_{\dot{Q}_{in}} + \underbrace{\dot{E}x_{\dot{Q}_{out}} - \dot{E}x_{\dot{s}_{det, \dot{s}_{gen}}}}_{-\dot{E}x_{det}} = \frac{d\dot{E}x}{dt} \tag{5}$$

where $\dot{E}x_{\dot{H}_{in}}$ and $\dot{E}x_{\dot{H}_{out}}$ are the exergy fluxes due to the total enthalpy respectively entering and exiting the control volume, $\dot{E}x_{\dot{W}}$ is the exergy flux due to indicated power, $\dot{E}x_{\dot{Q}_{in}}$ is the exergy flux due to heat transfer entering the control volume (positive value), $\dot{E}x_{\dot{Q}_{out}}$ is the exergy flux due to heat transfer lost by the control volume (negative value), $\dot{E}x_{\dot{s}_{det, \dot{s}_{gen}}}$ is the flux of exergy destruction due to the irreversibilities (entropy generation) and $\dot{E}x_{det}$ is the total flux of exergy destruction.

The exergy flux due to total enthalpy flux is evaluated as follows:

$$\dot{E}x_{\dot{H}} = \dot{m} \left((h(T) - h(T_{ref})) - T_a (s(T) - s(T_{ref})) \right) \tag{6}$$

where h and s are respectively the specific enthalpy and entropy of air, T_a , T_{ref} and T are respectively the ambient, the reference and the control volume temperatures. The specific enthalpy and entropy of Equation (6) are determined using the model of perfect gas [29].

The heat exchangers are considered ideal in the exergetic models: the heat exchanges are supposed with a constant wall temperature T_w equal to the hot or cold source temperature for the hot and cold heat exchanger respectively. The exergy flux due to heat transfer is calculated as follows:

$$\dot{E}x_{\dot{Q}} = \left(1 - \frac{T_a}{T_w}\right) \dot{Q} \tag{7}$$

The exergy flux associated to a mechanical power is written:

$$\dot{E}x_{\dot{W}} = \dot{W} \tag{8}$$

The destroyed exergy associated to an entropy generation is evaluated as follows:

$$\dot{E}x_{det, \dot{S}_{gen}} = T_a \dot{S}_{gen} \tag{9}$$

where \dot{S}_{gen} is the flux of generated entropy.

The general exergy balance Equation (5), applied on each component of the two hot air engines during one cycle, are detailed in Table 2.

Table 2. Exergy balance equations in the compression (C) and expansion (E) cylinders of the two hot air engines and in the regenerator (R) of the Stirling engine.

	Stirling engine		Ericsson engine	
(C)	$\dot{E}x_{\dot{H}_{in,c}} - \dot{E}x_{\dot{H}_{out,c}} + \dot{E}x_{\dot{W}_{ic}} + \dot{E}x_{\dot{Q}_k} - \dot{E}x_{det, \dot{S}_{gen,c}} = 0$	(a)	$\dot{E}x_{\dot{H}_{in,c}} - \dot{E}x_{\dot{H}_{out,c}} + \dot{E}x_{\dot{W}_{ic}} + \dot{E}x_{\dot{Q}_c} - \dot{E}x_{det, \dot{S}_{gen,c}} = 0$	(d)
(E)	$\dot{E}x_{\dot{H}_{in,e}} - \dot{E}x_{\dot{H}_{out,e}} + \dot{E}x_{\dot{W}_{ie}} + \dot{E}x_{\dot{Q}_h} - \dot{E}x_{det, \dot{S}_{gen,e}} = 0$	(b)	$\dot{E}x_{\dot{H}_{in,e}} - \dot{E}x_{\dot{H}_{out,e}} + \dot{E}x_{\dot{W}_{ie}} + \dot{E}x_{\dot{Q}_e} - \dot{E}x_{det, \dot{S}_{gen,e}} = 0$	(e)
(R)	$\left(\dot{E}x_{\dot{H}_{out,e}} - \dot{E}x_{\dot{H}_{in,c}}\right) - \left(\dot{E}x_{\dot{H}_{in,e}} - \dot{E}x_{\dot{H}_{out,c}}\right) - \dot{E}x_{det,r} = 0$	(c)	-	

In order to compare the exergy fluxes $\dot{E}x$ in both hot air engines, dimensionless exergy fluxes $\dot{E}x^d$ are defined as follows:

$$\dot{E}x^d = \frac{|\dot{E}x|}{\dot{E}x_{\dot{Q}_h}} \tag{10}$$

where $\dot{E}x_{\dot{Q}_h}$ is the exergy flux linked to the heat transfer from the hot source, that is evaluated from Equation (7) for the Stirling engine (physical uniform wall temperature assumed along the heater tubes whatever the direction of the flow) and from the following equation for the Ericsson engine (hypothesis

of an ideal external hot heat exchanger with no heat losses, non-isothermal heat transfer and unknown wall temperature repartition):

$$\dot{E}x_{Q_h, \text{Ericsson}} = \dot{E}x_{H_{in,e}} - \dot{E}x_{H_{out,c}} \quad (11)$$

3.3. Performances of the Hot Air Engines

Several energetic performances of the engines are considered: the indicated mean pressure IMP, the specific indicated work w_i , the global thermodynamic efficiency η_{th} and the global exergetic efficiency η_{ex} . The indicated mean pressure is written:

$$\text{IMP} = \frac{|W_i|}{V_{\text{swept},e}} \quad (12)$$

where $|W_i| = -W_{ie} - W_{ic}$ is the indicated work and $V_{\text{swept},e}$ is the swept volume of the expansion cylinder of the engine. The specific indicated work delivered by the engine is:

$$w_i = \frac{|W_i|}{m_{\text{air},e}} \quad (13)$$

where $m_{\text{air},e}$ is the mass of air entering the expansion cylinder during each cycle. The global thermodynamic efficiency of the engine is evaluated as follows:

$$\eta_{th} = \frac{-\dot{W}_{ie} - \dot{W}_{ic}}{\dot{Q}_h} \quad (14)$$

where \dot{W}_{ie} and \dot{W}_{ic} are the indicated powers of respectively the expansion and the compression cylinders. The global exergetic efficiencies of the Stirling and Ericsson engines are evaluated with the following Equation (15):

$$\eta_{ex} = \frac{-\dot{E}x_{\dot{W}_{ie}} - \dot{E}x_{\dot{W}_{ic}}}{\dot{E}x_{\dot{Q}_h}} \quad (15)$$

In the present Ericsson engine configuration (open cycle), the exhaust exergy flux from expansion chamber is injected in a second combustion chamber to clean gas but also to increase exergy of gas entering in the air-gas exchanger (H) (*cf.* Figure 4b). This exergy flux will be then partially recovered in the cogeneration unit.

Equation (16) defines a potential exergetic efficiency including the exhaust exergy flux as a produced exergy. This exergetic efficiency represents the maximal value which can be reached.

$$\eta_{\text{ex, Ericsson (potential)}} = \frac{-\dot{E}x_{\dot{W}_{ie}} - \dot{E}x_{\dot{W}_{ic}} + \dot{E}x_{\dot{H}_{out,e}}}{\dot{E}x_{\dot{Q}_h}} \quad (16)$$

The exergy efficiencies (ratio between produced exergy and resource exergy) respectively of the compression chamber (C), expansion chamber (E) and regenerator (R) for both Stirling and Ericsson engines are presented in Table 3.

Table 3. Exergy efficiencies in each part of the two hot air engines.

Stirling		Ericsson	
(C)	$\eta_{ex,c} = \frac{\dot{E}X_{\dot{H}_{out,c}}}{\dot{E}X_{\dot{W}_{ic}} + \dot{E}X_{\dot{H}_{in,c}}}$	(a)	$\eta_{ex,c} = \frac{\dot{E}X_{\dot{H}_{out,c}} - \dot{E}X_{\dot{H}_{in,c}}}{\dot{E}X_{\dot{W}_{ic}}}$ (d)
(E)	$\eta_{ex,e} = \frac{-\dot{E}X_{\dot{W}_{ie}}}{\dot{E}X_{\dot{H}_{in,e}} - \dot{E}X_{\dot{H}_{out,e}} + \dot{E}X_{\dot{Q}_h}}$	(b)	$\eta_{ex,e} = \frac{-\dot{E}X_{\dot{W}_{ie}}}{\dot{E}X_{\dot{H}_{in,e}} - \dot{E}X_{\dot{H}_{out,e}}}$ (e)
(R)	$\eta_{ex,r} = \frac{\dot{E}X_{\dot{H}_{in,e}} - \dot{E}X_{\dot{H}_{out,c}}}{\dot{E}X_{\dot{H}_{out,e}} - \dot{E}X_{\dot{H}_{in,c}}}$	(c)	-

In the present paper, the main objective is to highlight the exergetic performances and the exergy fluxes in the components of both engines studied and to compare the exergetic efficiencies, the repartition of exergy fluxes and of destroyed exergy in the different parts of both engines. The quantitative comparison of the global performances of both particular engines studied presents little interest, since the dimensions of the engines differ significantly (*cf.* Table 1).

4. Results and Discussion

4.1. Working Conditions of the Stirling and Ericsson Engines

The working conditions considered for both engines studied are presented in Table 4. For the Stirling engine, the working pressure is defined as the mean pressure in operation and for the Ericsson engine, it corresponds to the pressure in the hot heat exchanger. For the exergetic analyses, the ambient temperature is supposed to be equal to 293.15 K. The reference temperature and pressure used for the evaluation of specific enthalpy and entropy are respectively 298.15 K and 101325 Pa. The heat losses at the walls of the Ericsson cylinders are neglected. The heat exchanges at the compression and expansion cylinder walls of the Stirling engine (heat transfers with hot and cold sources) include the heat losses. The dynamic effects of flows in both engines are considered (pressure drops during the transfers of working fluid).

Table 4. Working conditions of the two hot air engines.

working pressure	7 bar
hot source temperature	1000 K
cold source temperature	300 K
cycle frequency	10 Hz

4.2. Performances

Table 5 shows the global performances of the Stirling and Ericsson engines. The indicated mean pressure IMP of the Ericsson engine is 2.19 bar. This corresponds to a higher indicated work per cycle for the Ericsson engine if the engines present the same expansion swept volume. The specific indicated

work, the global thermodynamic efficiency and the global exergetic efficiency of the Stirling engine are higher than those of the Ericsson engine. These results might be explained by the presence of a regenerator in the Stirling engine, while there is no preheater in the Ericsson engine (component equivalent to the regenerator). The global exergetic efficiency of the Ericsson engine becomes higher if the exergy of exhaust gas is recovered.

Table 5. Global performances of the two hot air engines.

	Ericsson	Stirling
indicated mean pressure IMP (bar)	2.19	1.69
specific indicated work w_i (J/kg)	180848	269565
global thermodynamic efficiency η_{th} (%)	28.64%	37.42%
global exergetic efficiency η_{ex} (%)	47.59%	56.09%
Ericsson potential exergetic efficiency $\eta_{ex,pot}$ (%)	59.48%	-

4.3. Dimensionless Exergy Fluxes

The dimensionless exergy fluxes are presented in Figure 5. The highest exergy fluxes are situated in the expansion cylinder, which corresponds to the main component producing mechanical power. The dimensionless exergy flux reaches a value over 1 for the air entering the expansion cylinder of the Ericsson engine because the hot source is not the only exergy source producing the inlet air of the expansion cylinder: the air at the outlet of the compression cylinder is also involved. This value over 1 induces a dimensionless exergy flux associated with the indicated power generated in the expansion cylinder close to 1. For both engines, the highest exergy destruction occurs in the compression cylinders and is due to generated entropy: compression work (pure exergy) is converted into air at high pressure (exergy linked to the thermodynamic conditions of air which is dependent on the specific entropy, *cf.* second factor of Equation (6)). The exergy destruction in the compression cylinder of the Stirling engine is partly linked to the heat transfer with the cold source (K). The exergy destruction in the expansion cylinder is caused by the conversion of the exergy linked to the variation of the thermodynamic state of air into indicated work (entropy generated during this process). For the Ericsson engine, the entropy generated in both cylinders is associated with the air intake, air exhaust and air displacement phases, the compression and expansion phases being supposed adiabatic reversible. The generated entropy in both cylinder of the Stirling engine is partly due to the pressure losses during the air displacement phases. The dimensionless exergy flux linked to the production of indicated work in the expansion cylinder is higher for the Ericsson engine. However, due to the higher dimensionless exergy flux required in the compression cylinder during the process, the dimensionless exergy flux linked to the global indicated work is lower for the Ericsson engine.

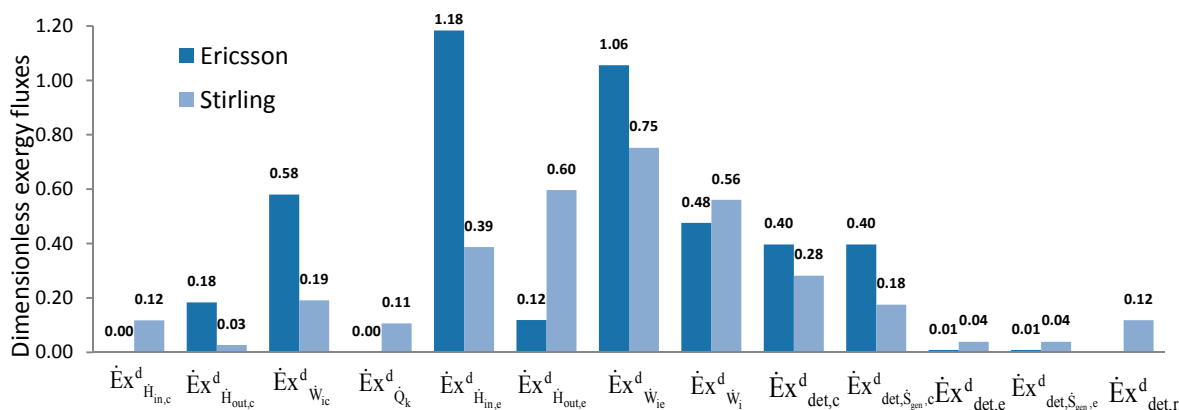

Figure 5. Dimensionless exergy fluxes (compared with the thermal exergy flux from the hot source) in the components of the Stirling and Ericsson engines.

4.4. Exergetic Efficiencies

The exergetic efficiencies in the components of the Stirling and Ericsson engines are represented in Figure 6. The exergetic efficiency in the compression cylinder is lower than in the expansion cylinder for both engines, probably because of the nature of the produced exergy and the resource exergy in both cylinders: in the compression cylinder, the compression work (pure exergy) is converted into air at a thermodynamic state with higher energy level (energy resource that cannot be totally converted into reversible work due to entropy generation), whereas the inverse process occurs in the expansion cylinder, leading to a produced energy corresponding to pure exergy. The global exergetic efficiency is higher for the Stirling engine: 56.09% for the Stirling engine and 47.59% for the Ericsson engine. This can be explained by the high exergetic efficiency of the Stirling engine regenerator (75.28%).

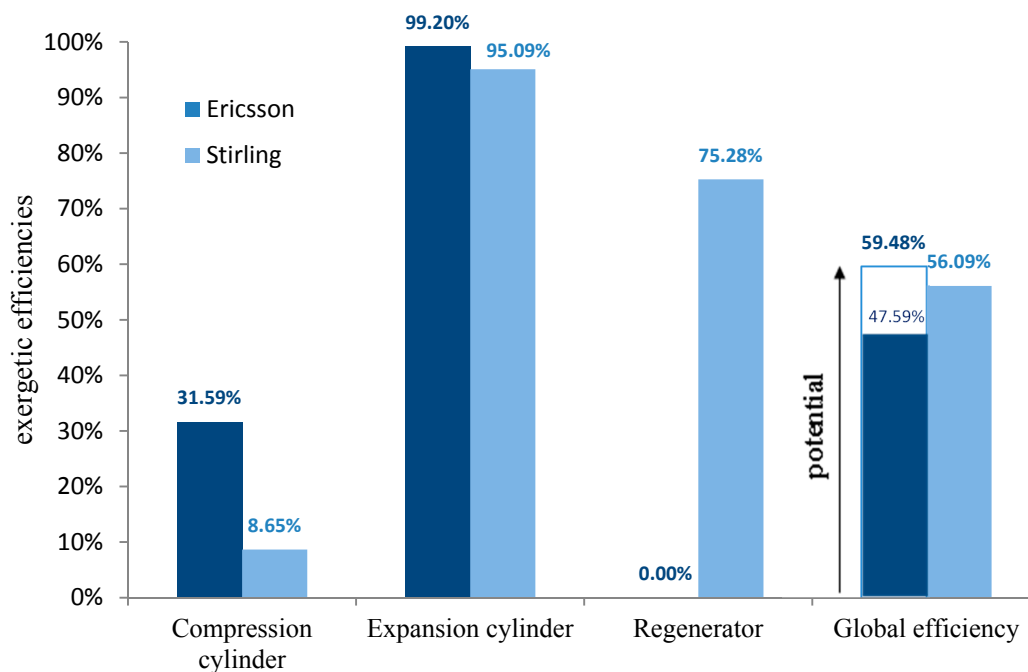

Figure 6. Exergetic efficiencies in the components of the two hot air engines.

4.5. Sankey Diagrams

The dimensionless exergy fluxes (*cf.* Equation (10)) in the Stirling and Ericsson engines are presented in Figure 7, using a Sankey diagram where the arrow width is proportional to the dimensionless exergy flow.

The total dimensionless exergy destruction is similar for both engines (44% and 41%, respectively, of the exergy flux from the hot source for the Stirling and Ericsson engines), when the hot air at the exhaust of the expansion cylinder is not considered as destroyed exergy. If this hypothesis is not assumed, the dimensionless exergy destruction in the Ericsson engine reaches 53% of the exergy flux from the hot source.

The Sankey diagrams highlight previous results observed. The expansion cylinder presents the lowest exergy destruction, whereas the compression cylinder generates the highest exergy destruction. The exergy destruction in the compression cylinder is mainly due to entropy generation for the Ericsson engine, while for the Stirling engine, the repartition of destroyed exergy due to entropy generation and heat losses towards the cold source heat exchanger are of the same order. The regenerator of the Stirling engine is also a source of exergy destruction, with intermediate values between the expansion and compression cylinders.

However, this component generates an important part of the exergy resource used in the expansion cylinder (28%). In the Ericsson engine, the compression cylinder represents the second dimensionless exergy flux entering the expansion cylinder, which corresponds to a lower proportion of the total dimensionless exergy flux entering the expansion cylinder (15%). Considering the exergy flux of air at the outlet of the expansion cylinder, the Ericsson engine configuration with a preheater might lead to a similar proportion, as in the Stirling engine, of secondary dimensionless exergetic flux entering the expansion cylinder.

The ratio of dimensionless exergy flux linked to the compression and expansion works is higher for the Ericsson engine compared to the Stirling engine, due to the difference in the ratios of compression and expansion swept volumes in both engines (*cf.* Table 1).

The two Sankey diagrams of Figure 7 highlight the exergy exchanges in both engines, the interactions between the engine components in terms of exergy transfer and the exergy destruction associated with each component. To optimize the performances of both engines, the first component to investigate should be the compression cylinder. However, the potential reduction of exergy destruction is limited to the exergy destruction linked to heat transfer (the exergy destruction linked to generated entropy is inevitable).

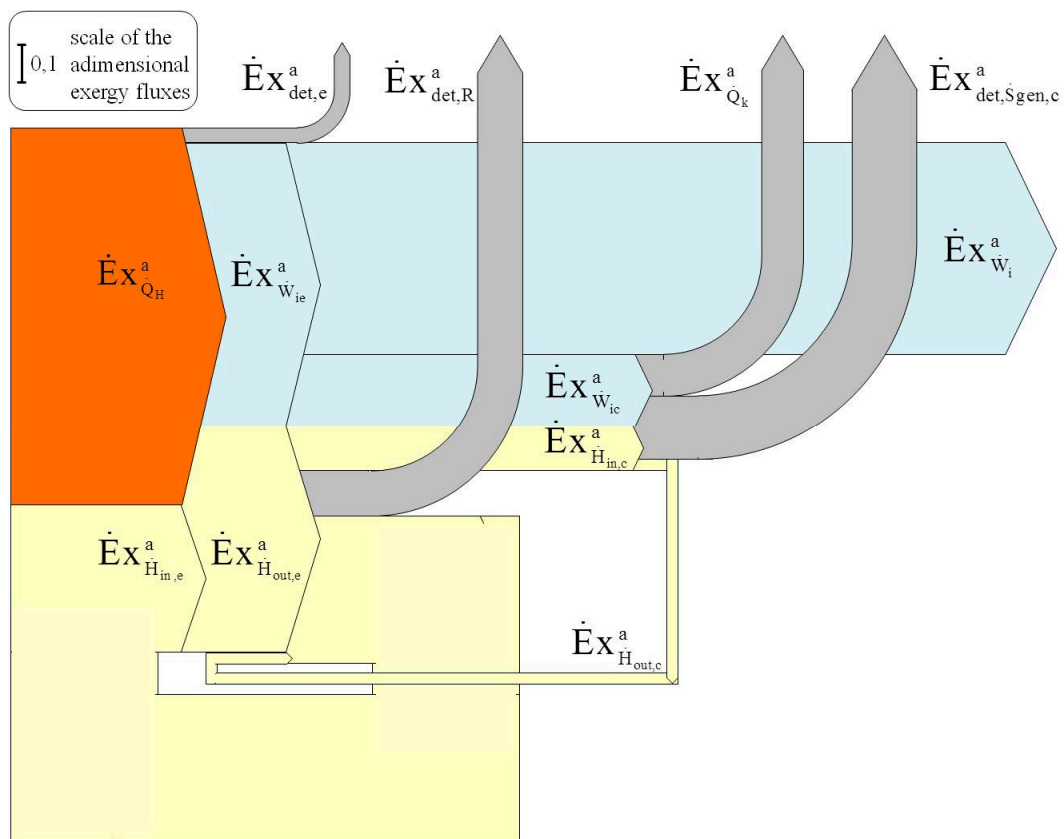

(a)

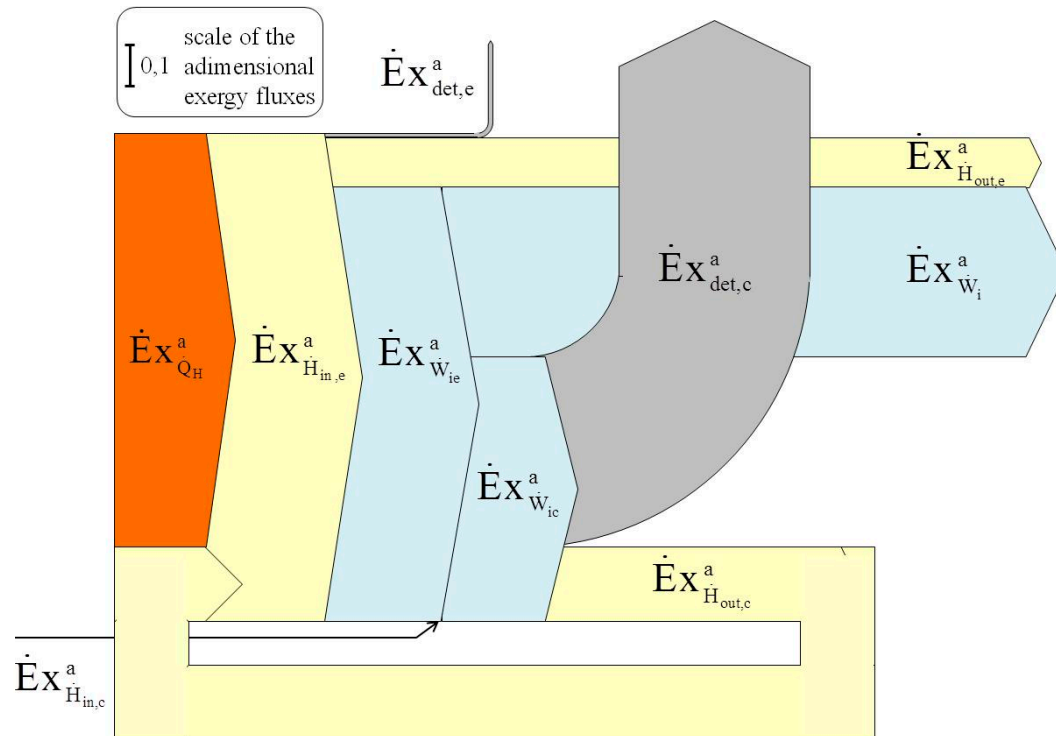

(b)

Figure 7. Sankey diagrams of the dimensionless exergy fluxes in the Stirling (a) and Ericsson (b) engines.

5. Conclusions

Based on previous energetic analyses described in the literature [27,28], two exergetic models of a Stirling and of an Ericsson engine were established. The global energetic and exergetic performances of both engines were evaluated. The exergy fluxes and the exergetic efficiencies in the components of the engines were determined, allowing a comparison of the repartition of exergy fluxes in both engines and the location of the exergy destruction.

The Stirling engine studied here presents higher global performances (specific indicated work, thermodynamic and exergetic efficiencies) compared with the Ericsson engine presented, due to the presence of a regenerator. The gap between these performances (about 8.5% of global exergetic efficiency and 8.78% of global thermodynamic efficiency) might be reduced using a preheater in the Ericsson engine. The exergetic efficiency gap can be filled with an injection of exhaust gas in the combustion process of the cogeneration unit.

The results show that the proportion of total exergy destruction compared with the exergy flux from the heat source is similar for both engines (44% and 41%, respectively, of the exergy flux from the hot source for the Stirling and Ericsson engines if the exergy of the exhaust gases is recovered for the last one). The largest exergy destruction occurs in the compression cylinder, mainly due to generated entropy in the case of the Ericsson engine and due to a similar proportion of generated entropy and of heat loss towards the cold source heat exchanger for the Stirling engine. The importance of the regenerator (or preheater for the Ericsson engine) to supply the expansion cylinder with a high exergy flux is highlighted: the exergy recovered reaches about 25% of the destroyed exergy.

Acknowledgments

This work has been performed in partnership with the laboratories LAMIH (Valenciennes, France), LESTE (Monastir, Tunisia), PC2A (Lille, France) and CCM (Dunkerque, France). Financial support has been provided by the Région Nord-Pas-de-Calais, by the French National Association of Research and Technology ANRT (doctoral scholarship) and by the company Enerbiom in the framework of the regional project Sylwatt, by the European Commission within the International Research Staff Exchange Scheme (IRSES) in the 7th Framework Programme FP7/2014-2017/ under REA grant agreement n°612230, and by the Tunisian Ministry of Higher Education and Scientific Research (doctoral scholarship). These supports are gratefully acknowledged.

Author Contributions

This study synthesizes and compares the research works on a Stirling engine (by Houda Hachem, Ramla Gheith, Fethi Aloui and Sassi Ben Nasrallah) and the research works on an Ericsson engine (by Marie Creyx, Eric Delacourt and Céline Morin). The draft of the paper was written by Houda Hachem (sections on the Stirling engine) and by Marie Creyx (sections on the Ericsson engine). Both of them wrote the comparative analysis of the engines. All co-authors revised and approved the final version.

Conflicts of Interest

The authors declare no conflict of interest.

Nomenclature

\dot{E}_x	exergy flux (W)
$\dot{E}_{x_{det}}$	total destroyed exergy flux (W)
$\dot{E}_{x_{det,S_{gen}}}$	destroyed exergy flux associated to entropy generation (W)
h	specific enthalpy (J/kg)
\dot{H}	total enthalpy flux (W)
IMP	indicated mean pressure (Pa)
$m_{air,e}$	mass of air entering the expansion cylinder during each cycle (kg)
P	pressure (Pa)
Q	heat exchanged (J)
\dot{Q}	heat flux (W)
r	air specific gas constant (J/kg.K)
s	specific entropy (J/kg.K)
\dot{S}_{gen}	flux of generated entropy (W/K)
t	time (s)
T	temperature (K)
U	internal energy (J)
V	volume (m ³)
$V_{swept,e}$	swept volume of the expansion cylinder (m ³)
W	indicated work (J)
\dot{W}	indicated power (W)
w_i	specific indicated work (J/kg)

Greek letters

η_{ex}	exergetic efficiency (%)
η_{th}	thermodynamic efficiency (%)

Subscripts

a	Ambient
c	Compression cylinder
e	Expansion cylinder
h	hot source or hot temperature heat exchanger
i	indicated
k	cold source or cold temperature heat exchanger
in	Input
max	Maximum
min	Minimum
r	Regenerator
ref	Reference
out	Output
w	wall

Superscripts

d	dimensionless
---	---------------

Abbreviations

C	compression chamber (Ericsson engine)
E	expansion chamber (Ericsson engine)
H	heat exchanger in contact with hot source
K	heat exchanger in contact with cold source
R	regenerator

References

1. Creyx, M.; Delacourt, E.; Morin, C.; Desmet, B.; Peultier, P. Energetic optimization of the performances of a hot air engine for micro-CHP systems working with a Joule or an Ericsson cycle. *Energy* **2013**, *49*, 229–239.
2. Simader, G.R.; Krawinkler, R.; Trnka, G. *Micro CHP Systems: State-of-the-Art*; Österreichische Energieagentur–Austrian Energy Agency: Vienna, Austria, 2006.
3. Angelino, G.; Invernizzi, C. Real gas effects in Stirling engines. In Proceedings of the Energy Conversion Engineering Conference and Exhibit (IECEC) 35th Intersociety, Las Vegas, NV, USA, 24–28 July 2000.
4. Costea, M.; Feidt, M. The effect of the overall heat transfer coefficient variation on the optimal distribution of the heat transfer surface conductance or area in a Stirling engine. *Energy Convers. Manag.* **1998**, *39*, 1753–1761.
5. Parlak, N.; Wagner, A.; Elsner, M.; Soyhan, H.S. Thermodynamic analysis of a gamma type Stirling engine in non-ideal adiabatic conditions. *Int. J. Renew. Energy* **2009**, *34*, 266–273.
6. Touré, A.; Soubacq, S.; Alaphilippe, M.; Marquet, D.; Stouffs, P. Design, experimental setup and preliminary testing results of a small Joule cycle Ericsson engine prototype. In Proceedings of the International Stirling Forum, ISF 2008, Osnabrück, Germany, 23–23 September 2008.
7. Brzeski, L.; Kazimierski, Z.; Experimental investigations of the externally heated valve engine model. *Proc. Inst. Mech. Eng. A* **2001**, *215*, 486–494.
8. Wu, D.; Roskilly, A.P. Design and parametric analysis of linear Joule-cycle engine with out-of-cylinder combustion. In Proceedings of the 6th International Conference on Applied Energy, ICAE 2014, Taipei, Taiwan, 30 May–2 June 2014.
9. Wojewoda, J.; Kazimierski, Z. Numerical model and investigations of the externally heated valve Joule engine. *Energy* **2010**, *35*, 2099–2108.
10. Moss, R.W.; Roskilly, A.P.; Nanda, S.K. Reciprocating Joule-cycle engine for domestic CHP systems. *Appl. Energy* **2005**, *80*, 169–185.
11. Bell, M.A.; Partridge, T. Thermodynamic design of a reciprocating Joule cycle engine. *Proc. Inst. Mech. Eng. A* **2003**, *217*, 239–246.
12. Thombare, D.G.; Verma, S.K. Technological development in the Stirling cycle engines. *Int. J. Renew. Sust. Energy* **2008**, *12*, 1–38.
13. Berchowitz, D.M. Free-Piston Rankine Compression and Stirling Cycle Machines for Domestic Refrigeration. In Proceedings of the Greenpeace Ozone Safe Conference, Washington, VA, USA, 18–19 October 1993.
14. Urieli, I.; Berchowitz, D.M. *Stirling Cycle Engine Analysis*; Taylor & Francis: London, UK, 1984.

15. Bonnet, S.; Alaphilippe, M.; Stouffs, P. Energy, exergy and cost analysis of a micro-cogeneration system based on an Ericsson engine. *Int. J. Therm. Sci.* **2005**, *44*, 1161–1168.
16. Martaj, N.; Grosu, L. Exergetical analysis and design optimisation of the Stirling engine. *Int. J. Exergy* **2006**, *3*, 45–67.
17. Martaj, N.; Grosu, L.; Rochelle, P. Thermodynamic Study of a Low Temperature Difference Stirling Engine at Steady State Operation. *Int. J. Thermodyn.* **2007**, *10*, 165–176.
18. Hachem, H.; Gheith, R.; Aloui, F.; Ben Nasrallah, S.; Dincer, I. Energetic and Exergetic Performance Assessments of an Experimental Beta Type Stirling Engine. In Proceedings of the 7th International Ege Energy Symposium & Exhibition (IEESE 2014), Usak, Turkey, 18–20 June 2014.
19. Saneipoor, P.; Naterer, G.F.; Dincer, I. Heat recovery from a cement plant with a Marnoch Heat Engine. *Appl. Therm. Eng.* **2011**, *31*, 1734–1743.
20. Saneipoor, P.; Dincer, I.; Naterer, G.F. Thermodynamic analysis of a new Marnoch Heat Engine. *Appl. Therm. Eng.* **2013**, *52*, 516–526.
21. Saneipoor, P.; Naterer, G.F.; Dincer, I. Power generation from a new air-based Marnoch heat engine. *Energy* **2011**, *36*, 6879–6889.
22. Stouffs, P. Does the Ericsson engine deserves more consideration than the Stirling engine? In Proceedings of the European Stirling Forum, Osnabrück, Germany, 18–19 September 2002.
23. Gheith, R.; Aloui, F.; Tazerout, M.; Ben Nasrallah, S. Experimental investigations of a Gamma Stirling engine. *Energy Res.* **2012**, *36*, 1175–1182.
24. Gheith, R.; Aloui, F.; Ben Nasrallah, S. Study of regenerator constituting material influence on a Gamma type Stirling engine. *J. Mech. Sci. Technol.* **2012**, *26*, 1251–1255.
25. Gheith, R.; Aloui, F.; Ben Nasrallah, S. Determination of adequate regenerator for a Gamma-type Stirling engine. *Appl. Energy* **2015**, *139*, 272–280.
26. Gheith, R.; Aloui, F.; Ben Nasrallah, S. Optimization of Stirling engine performance based on an experimental design approach. *Int. J. Energy Res.* **2013**, *37*, 1519–1528.
27. Hachem, H.; Gheith, R.; Aloui, F.; Ben Nasrallah, S. Global numerical characterization of a γ -Stirling engine considering losses and interaction between functioning parameters. *Energy Convers. Manag.* **2015**, *96*, 532–543.
28. Creyx, M.; Delacourt, E.; Lippert, M.; Morin, C.; Desmet, B. Modélisation des performances d'un moteur Ericsson à cycle de Joule ouvert. *Revista Termotehnica* **2014**, *1*, 64–70. (In French)
29. Moran, M.J.; Shapiro, H.N. *Fundamentals of Engineering Thermodynamics*; Wiley: Chichester, UK, 2006.
30. Dincer, I.; Rosen, M.A. *Exergy: Energy, Environment and Sustainable Development*; Elsevier: Amsterdam, The Netherlands, 2007.