



**HAL**  
open science

## Passive control of deep cavity shear layer flow at subsonic speed

Mouhammad El Hassan, Laurent Keirsbulck

► **To cite this version:**

Mouhammad El Hassan, Laurent Keirsbulck. Passive control of deep cavity shear layer flow at subsonic speed. *Canadian Journal of Physics*, 2017, 95 (10), pp.894-899. 10.1139/cjp-2016-0822 . hal-03451798

**HAL Id: hal-03451798**

**<https://uphf.hal.science/hal-03451798>**

Submitted on 15 Apr 2022

**HAL** is a multi-disciplinary open access archive for the deposit and dissemination of scientific research documents, whether they are published or not. The documents may come from teaching and research institutions in France or abroad, or from public or private research centers.

L'archive ouverte pluridisciplinaire **HAL**, est destinée au dépôt et à la diffusion de documents scientifiques de niveau recherche, publiés ou non, émanant des établissements d'enseignement et de recherche français ou étrangers, des laboratoires publics ou privés.



Distributed under a Creative Commons Attribution 4.0 International License

**Passive control of deep cavity shear layer flow at subsonic speed**

Journal:	<i>Canadian Journal of Physics</i>
Manuscript ID	cjp-2016-0822.R1
Manuscript Type:	Article
Date Submitted by the Author:	26-Feb-2017
Complete List of Authors:	El Hassan, Mouhammad; University of Calgary Keirsbulck, Laurent; LAMIH, UMR 8201
Keyword:	Cavity flow, PIV, Flow control, shear layer, shear layer growth
Please Select from this Special Issues list if applicable:	

SCHOLARONE™  
Manuscripts

Only

# Passive control of deep cavity shear layer flow at subsonic speed

Mouhammad El Hassan<sup>1</sup> and Laurent Keirsbulck<sup>2</sup>

<sup>1</sup>*University of Calgary, Mechanical Engineering Department, AB, Canada*

<sup>2</sup>*University of Valenciennes, Mechanical Engineering Department, France*

For Review Only

## Abstract

Passive control of the flow over a deep cavity at low subsonic velocity is considered in the present paper. The cavity length-to-depth aspect ratio is  $L/H = 0.2$ . Particle Image Velocimetry (PIV) measurements characterized the flow over the cavity and show the influence of the control method on the cavity shear layer development. It is found that both the “cylinder” and the “shaped cylinder”, placed upstream from the cavity leading edge, result in the suppression of the aero-acoustic coupling and highly reduce the cavity noise. It should be noted that the vortical structures impinge at almost the same location near the cavity downstream corner with and without passive control. The present study allows to identify an innovative passive flow control method of cavity resonance. Indeed, the use of a “shaped cylinder” present similar suppression of the cavity resonance as with the “cylinder” but with smaller impact on the cavity flow. The “shaped cylinder” results in a smaller shear layer growth as compared to the cylinder. Velocity deficiency and turbulence levels are less pronounced using the “shaped cylinder”. The “cylinder” tends to diffuse the vorticity in the cavity shear layer and thus the location of the maximum vorticity is more affected as compared to the “shaped cylinder” control. The fact that the “shaped cylinder” is capable of suppressing the cavity resonance, despite that the vortex shedding and the high frequency forcing are suppressed, is of high interest from fundamental and applied point of views.

## 1. Introduction

The flow-induced cavity resonance leads to a high acoustic level which in many industrial applications is problematic and needs to be strongly reduced or suppressed. Active and passive control strategies were proposed in the literature to decrease or suppress the cavity resonance. A review of active control of flow-induced cavity oscillations is presented in the paper of Cattafesta et al. [1]. Unlike active control which provides external energy input to the flow, passive control techniques consist of geometric modifications using, for example, rigid fixed spoilers or cylinders placed in the boundary layer near the leading edge of the cavity.

McGrath and Shaw [2] were the first to study the effect of a cylinder placed in the upstream boundary layer of shallow cavities for Mach numbers of 0.6 and 0.8. The cylinder, called a high-frequency tone generator, was capable of producing substantial reductions of both the cavity tones and the broadband acoustic level. However, no physical mechanism was proposed by the authors to explain the efficiency of such a passive control device.

To explain the mechanism of the acoustic suppression, Shaw [3] suggested that the cylinder could displace the boundary layer to break the acoustic feedback loop, or the high frequency vortex shedding in the cylinder wake acts to extract energy from the larger oscillating structures. These hypotheses were widely investigated by Stanek et al. [4-6] who suggested, consistently with the findings of Wiltse and Glezer [7], that the efficiency of a cylinder passive control is explained by the mechanism of high-frequency forcing which leads to an acceleration of the energy cascade. Consequently, the large-scale structures in the cavity shear layer are eliminated, the size of the smallest identifiable coherent structure (Kolmogorov scale) is reduced and the viscous dissipation rate increases. The authors suggested that the observed rise in the high frequency broadband levels in the acoustic spectra is consistent with intense accelerated mixing near the cavity leading edge which is consistent with enhanced diffusion of momentum and a consequent modification of the mean velocity profiles near the cavity leading edge. According to the Schlieren results of Deron et al. [8], the large-scale vortices in the cavity shear layer disappear and are replaced by small-scale structures of the cylinder wake. As a consequence, optical phase power spectral densities are transformed into a "less complex" power spectrum which represents the statical optical effects induced by the "Von Karman street" replaced flow, as stated by the authors. Illy et al. [9, 10] suggested that the perturbations induced by the cylinder break the cavity flow oscillation loop, probably through the cancellation of the vortex formation process which takes place in the very vicinity of the cavity leading edge. They stated that the very robust dynamic of the

cylinder instability imposes its own dynamics when it is immersed in the region of the cavity leading edge. Arunajatesan et al. [11] suggested that the acoustic suppression is related to a possible stabilization of the cavity shear layer due to the change in the mean axial shear layer velocity profiles in presence of the cylinder.

Most of the previous studies on the passive control of the cavity resonance focused on using a cylinder for high velocities of transonic or supersonic flows. On the other hand, the previous investigations discussed the pressure fluctuations and the acoustic resonance with a lack of the aerodynamic description of the interaction of the cylinder and cavity shear layer flows which is of high interest in order to understand the mechanisms involved in such a control method.

In the present investigation, a cylinder and a shaped cylinder are used to control the aero-acoustic resonance of a deep large cavity at low subsonic flow. The velocity and turbulence fields are obtained using PIV measurements for the optimal position of the cylinder and the shaped cylinder. The interest of using a shaped cylinder is related to its ability to highly reduce the shedding when a cylinder is being used. It will be shown that the shape cylinder presents the same efficiency of the cylinder to suppress the cavity resonance.

## 2. Apparatus and Experimental Procedure

### 2.1 Wind tunnel and cavity model details

The experimental measurements were conducted in the closed circuit low speed wind tunnel at the University of Valenciennes. The test section is  $2 \times 2 \text{ m}^2$  in cross-section and 10 m long. The maximum outlet velocity along the centerline of the test section is 60 m/s. PIV measurements were made at freestream velocities  $U_0 = 43 \text{ m/s}$ . The dimensions of the cavity were  $L = 104 \text{ mm}$  in length,  $H = 520 \text{ mm}$  in depth and  $W = 2000 \text{ mm}$  in width. Aspect ratios were  $L/H = 0.2$  and  $L/W = 0.052$ . The cavity was installed on the lateral wall of the test section, with the leading edge located 8 m downstream from the test section inlet. The boundary layer was characterized just upstream from the cavity leading edge. Hot-wire measurements of velocity profiles at this location showed that for low velocity ( $U_0 = 2 \text{ m/s}$ ) the boundary layer was fully developed [12]. This was also the case for  $U_0 = 43 \text{ m/s}$  [13].

A 6 mm diameter cylinder was placed 30 mm upstream from the cavity leading edge in the spanwise direction (figure 1). The vertical position of the cylinder to the wall ( $y_c = 10 \text{ mm}$ ) is chosen to allow an optimal control of the cavity resonance [13]. The cylinder induces a wake of vortices at a frequency dependent on its diameter and freestream velocity. Over a large range of Reynolds numbers the Strouhal number for the wake shedding is approximately constant

and equal to 0.2. The calculated shedding frequency was 900 Hz for  $U_0 = 43$  m/s. Note that the calculated value is not based on the tunnel freestream velocity, but on that within the boundary layer. The measured shedding frequencies were obtained from hot-wire measurements near the cylinder wake.

## 2.2 Pressure measurements

A Kulite pressure transducer was employed, with a nominal sensitivity of 275 mV/bar. The output from the transducer was connected to a multi-channel signal conditioner. Data acquisition of pressure signals was accomplished using an A/D board with 12 bit resolution. A gain adjustment was used in order to meet the required voltage input levels of the A/D board. Data were sampled at 6 kHz typically for 180000 samples (30 sec.). The acquired pressure signals were low-pass filtered with a cut-off frequency of 3 kHz, to avoid aliasing effects. The location of the pressure sensor is shown in Figure 1.

## 2.3 PIV measurements

The PIV system is based upon a time resolved PIV Dantec 'DynamicStudio' system, including a  $2 \times 10$ mJ dual YAG laser, a 3 kHz Photron Ultima APX-RS Camera (1024 x 1024 pixels) used at 2 kHz frequency (1 kHz vector map). The time between two laser pulses was 30 $\mu$ s. The PIV camera was mounted on a traversing system, perpendicular to the light sheet plane of the laser. PIV measurements were taken in a streamwise plane (x, y) normal to the wall.

Some of PIV measurement errors due to the camera calibration can be minimized by carefully choosing the experimental conditions, but others cannot be eliminated and need to be estimated. When the ratio of particle-image diameter  $d_{\text{par}}$  to the size of a CCD pixel on the photograph  $d_{\text{pix}}$  is less than 2, the energy spectrum is overestimated due to the "peack-locking" phenomenon [14]. About 3 pixels on average for each particle-image were yielded for the present measurement. According to Prasad et al. [15], the particle-images are adequately resolved for the present experiment. The mean velocity and RMS fields presented in this paper were obtained by averaging a series of 1000 instantaneous fields of the corresponding quantity.

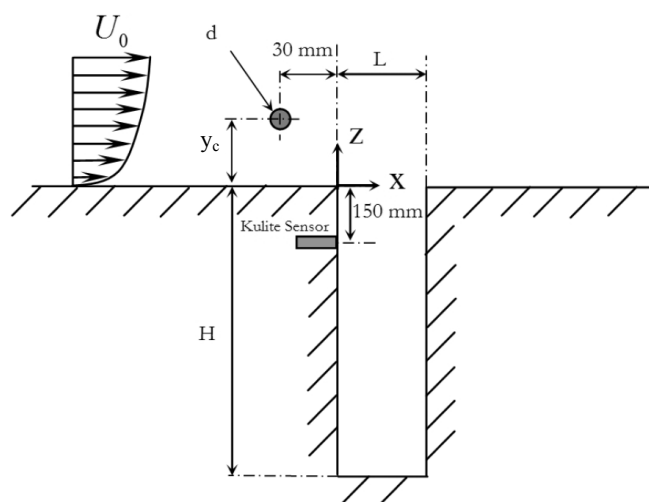

Figure 1: Position of the cylinder for cavity control

### 3. Results and Discussion

#### 3.1 Cylinder and shaped cylinder control of the cavity resonance

For the same cavity configuration, the authors showed in previous studies (El Hassan et al. [12], Keirsbulck et al. [13]) that the cylinder in cross flow is an effective device for suppressing acoustic resonance. It was stated in the literature [4-6] that the high frequency forcing (pulsing effect) of the cylinder is responsible for the cavity tone attenuation. A shaped cylinder (Figure 2) is used in the present study in order to minimize the shedding process of the cylinder. The sound pressure levels and normalized velocity spectra for “no control”, cylinder “control” cases and with a shaped cylinder for  $L/H = 0.2$  with respect to the optimal cylinder position ( $y_c/d = 1.67$ ), permitted to compare “shedding on” performance with “shedding off” performance. It was confirmed [13] that the cylinder resulted in a sharp high energetic peak in the velocity spectrum whereas the shaped cylinder exhibited no such energetic peak. El Hassan et al. [16] found that the noise frequency of the present studied configuration is around 151Hz.

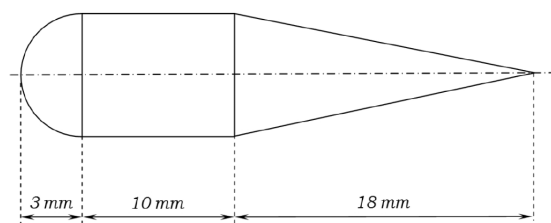

Figure 2: Shaped cylinder

Sound pressure level (SPL) reduction at the dominant cavity tone is shown in figure 3. This figure shows that the shaped cylinder presents a similar efficiency as the cylinder for the attenuation of tones for the studied freestream velocities. Consequently, the link between pulsing effect and the acoustic



resonance suppression suggested in the literature is not proved. To obtain a significant sound reduction, the pulsing effects of the cylinder are not necessary, only the presence of a body wake seems to be required.

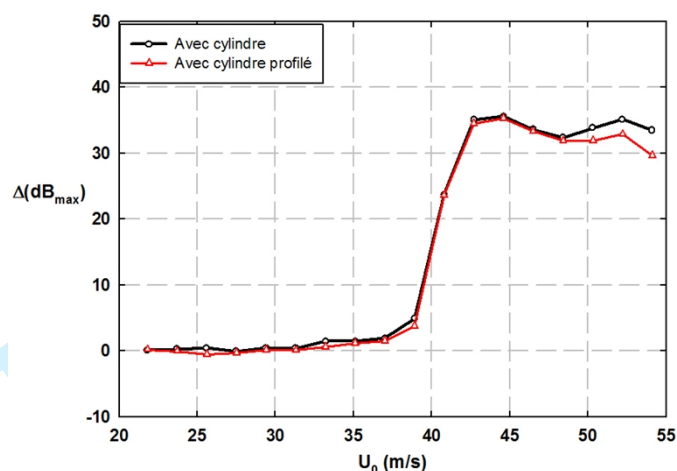
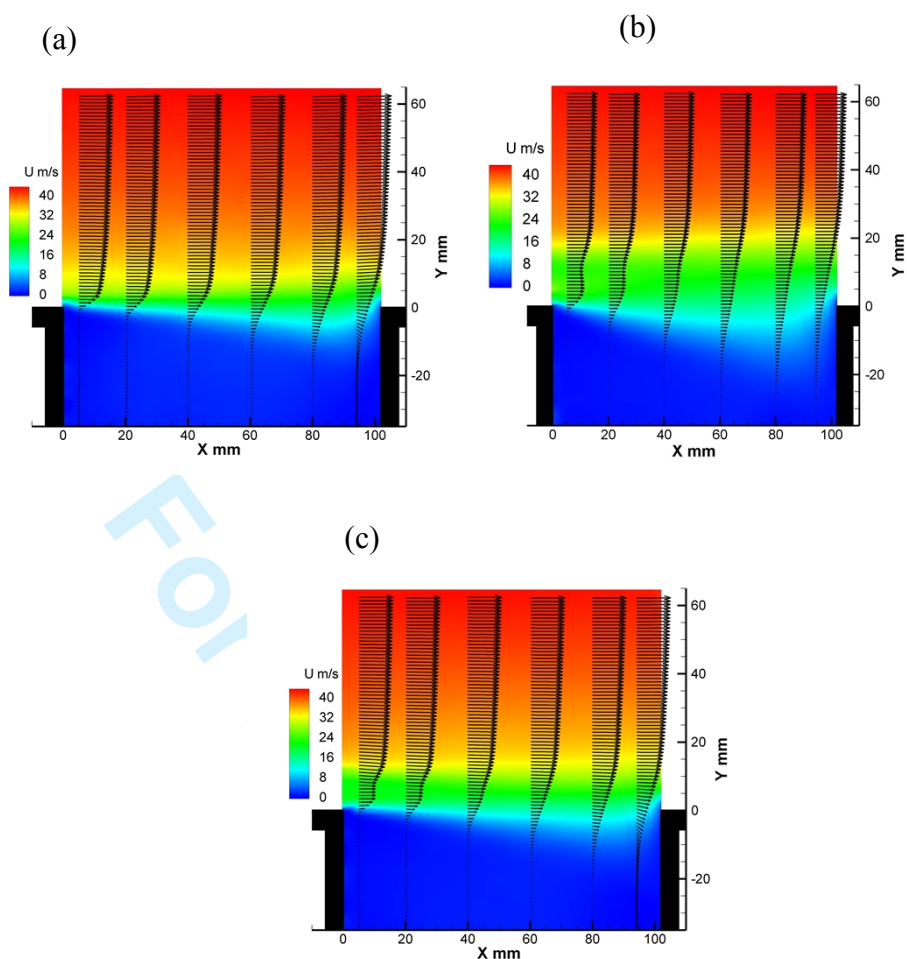

Figure 3: SPL reduction at dominant cavity tone for different freestream velocities

### 3.2 Influence of the passive control on the cavity mean flow

Velocity measurements were conducted using the PIV technique to provide quantitative description of the flow. The mean velocity and the mean streamwise RMS fields are represented in figures 4 and 7, respectively. Figure 4(a) shows that downstream from the cavity leading edge, the velocity profile changes from a boundary-layer profile to a shear layer profile. Thus, the shear layer grows and becomes thickened when traveling from the leading to the trailing edge of the cavity. Figures 4(b) and 4(c) show a velocity deficiency along the cavity shear layer in the wake region of the cylinder and the shaped cylinder. This deficiency contributes to thicken the shear layer when the control devices are being used. Illy et al. [9] found similar results with a cylinder placed upstream a deep cavity ( $L/H = 0.42$ ) for transonic flow ( $M = 0.8$ ).



**Figure 4: Mean streamwise velocity distribution without control (a), with the cylinder (b) and the shaped cylinder (c)**

In order to quantify the effect of the cylinder and the shaped cylinder on the development of the cavity shear layer, the growth rate of the cavity shear layer was investigated using the momentum thickness  $\theta$ . Figure 5 shows the variation of momentum thickness along the cavity shear layer. The plots illustrate the linear growth of  $\theta$  over almost the entire span of the cavity.

Three regions may be defined in figure 5:

Region I ( $0 < x < 20\text{mm}$ ): the momentum thickness grows linearly with a growth rate equal to 0.06 without control, 0.077 with the cylinder and 0.071 with the shaped cylinder. The “collective interaction mechanism” described by Ho and Huang [17] could explain the high initial spreading rate for the “no control” case compared to that found in equilibrium shear layers. This mechanism could explain the existence of large coherent structures in the cavity shear layer (Gharib and Roshko [18]). The presence of the vortical structures generated by the control device and their important expansion could explain the higher spreading rates observed in the controlled cases.

Region II: the growth rate is equal to 0.039 without control, 0.042 with the cylinder and 0.027 with the shaped cylinder.

Region III: the momentum thickness decreases as the flow approaches the downstream edge of the cavity.

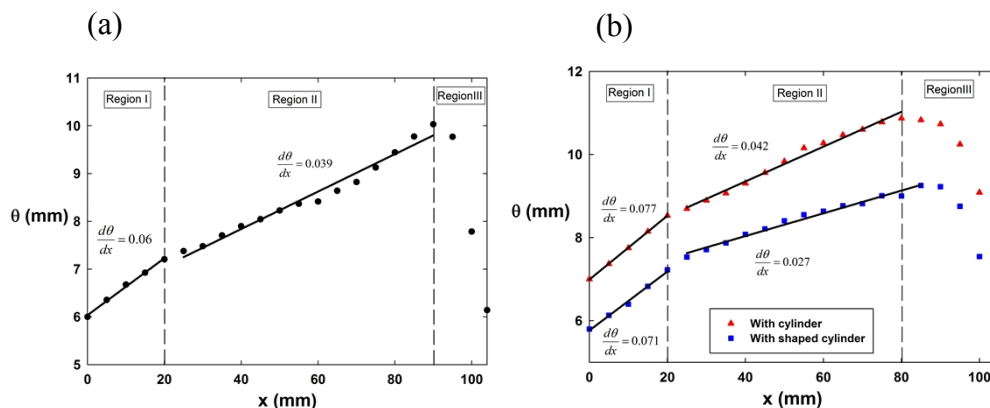

Figure 5: Momentum thickness of the mixing layer: without control (a) and with passive control (b)

Forestier et al. [19] distinguished three regions of the spreading rate distribution along a deep cavity shear layer. These authors also found three regions of the spreading rate distribution along the cavity shear layer. They found a spreading rate similar to that of the present study ( $d\theta/dx = 0.042$ ) in “region II” of the cavity shear layer. However the spreading rate in “region I” was high ( $d\theta/dx = 0.12$ ) due to the higher Mach number  $M = 0.8$  used by these authors as compared to the low subsonic flow of our experiment ( $M = 0.13$ ).

Levasseur et al. [20] used a cylinder to control the resonance of a cavity flow. They found that with the cylinder control the cavity shear layer deviates from its horizontal position. Deflection of the cavity shear layer is studied for the two control devices of the present study. The mean position of the shear layer is defined as the point of the maximum vorticity. The distribution of this position is presented in figure 6(a). This figure illustrates that the presence of the maximum of vorticity is affected for some positions along the cavity shear layer due to the passive control. Indeed, the cylinder tends to diffuse the vorticity in the shear layer and the maximum position alternates from inside to outside the centerline of the cavity shear layer. With the shaped cylinder, the maximum vorticity position is less affected. It is also observed (figure 6(a)) that near the cavity downstream corner, the vortical structures impinge at almost the same position with and without passive control. Figure 6(b) shows that the streamwise vorticity generated by the cylinder tends to weaken the vorticity in the cavity shear layer (figure 6(b)). It is interesting to note that the attenuation of the maximum vorticity amplitude is absent with the shaped cylinder.

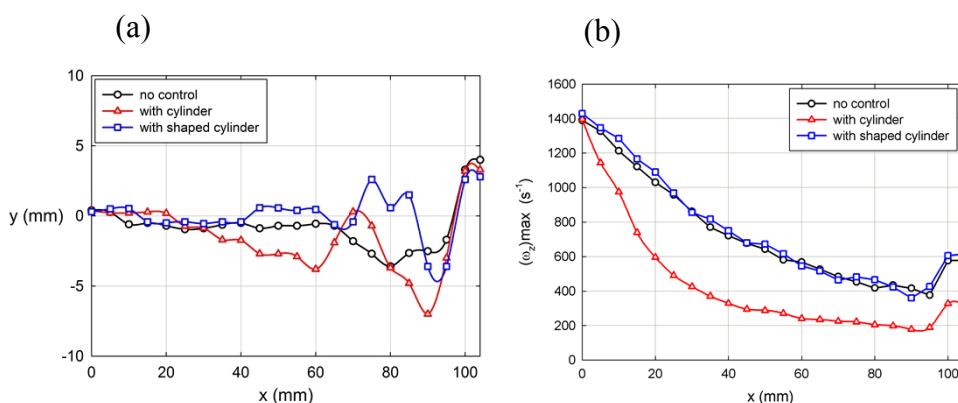

Figure 6: Mean shear layer position (a) and the corresponding vorticity amplitude (b)

The mean streamwise Standard Deviation ( $U_{Std Dev}$  or  $U_{RMS}$ ) distribution is presented in figure 7. Without control (figure 7(a)),  $U_{RMS}$  shows high values in the downstream part of the cavity shear layer due to the growth of the large vortical structures when traveling towards the cavity downstream corner. With the cylinder (figure 7(b)), an important increase in  $U_{RMS}$  is observed in the upstream part of the cavity shear layer. Along the cavity shear layer,  $U_{RMS}$  profile presents double peaks related to the cylinder shedding and the vortical structures in the cavity shear layer. With the shaped cylinder (figure 7(c)),  $U_{RMS}$  distribution shows a dramatic amplitude decrease as compared to the cylinder. This distribution confirms the smaller impact of the shaped cylinder on the cavity shear layer. It also confirms the suppression of the high frequency forcing which is related to the presence of energetic large scale vortical structures in the cylinder wake.

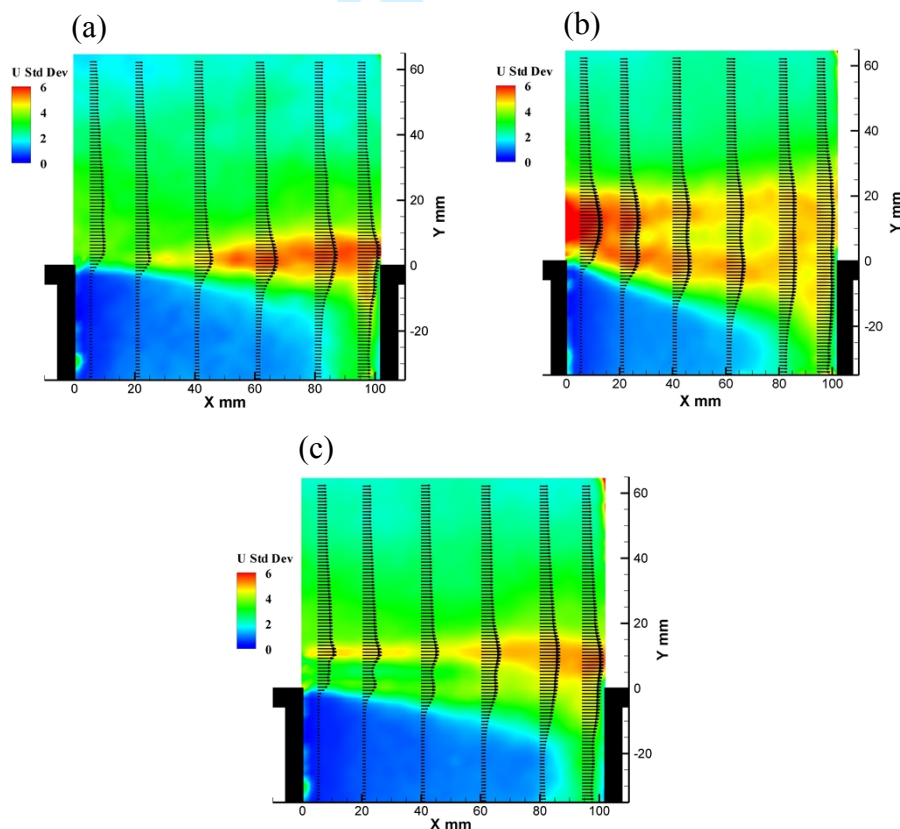

Figure 7: Mean streamwise RMS distribution without control (a), with the cylinder (b) and the shaped cylinder (c)

#### 4. Conclusion

The flow dynamics and the shear layer growth over a rectangular deep cavity ( $L/H = 0.2$ ) are experimentally investigated in the present paper using Particle Image Velocimetry (PIV), with and without passive flow control. It is found that despite the smaller impact of the shaped cylinder on the cavity flow, both the cylinder and the shaped cylinder result in similar suppression of the cavity resonance when placed upstream from the cavity leading edge. The vortical structures that develop along the cavity shear layer impinge at almost the same location near the cavity downstream corner with and without passive control. The shaped cylinder results in a smaller growth of the cavity shear layer as compared to the cylinder. The velocity deficiency and turbulence level above the cavity shear layer are less pronounced using the shaped cylinder as compared to the cylinder. It can be observed that the vorticity generated by the cylinder tends to weaken the vorticity in the cavity shear layer whereas such attenuation is absent with the shaped cylinder.

The present study suggests that the cavity resonance can be suppressed despite the absence of high frequency forcing related to the vortex shedding behind the passive control device placed upstream from the cavity leading edge.

#### References

- [1] Cattafesta L.N., Williams D.R., Rowley C.W. and Alvi F.S. Review of active control of flow-induced cavity resonance. AIAA Paper 2003-3567 (2003).
- [2] McGrath S.F. and Shaw L.L. (1996) Active control of shallow cavity acoustic resonance. AIAA Paper 96-1949
- [3] Shaw L. (1998) Active control for cavity acoustics. AIAA-98-2347, 19th AIAA Aeroacoustics conference, Toulouse, France, June.
- [4] Stanek M.J., Raman G., Kibens V., Ross J.A., Odredra J., Peto J.W. (2000) Control of cavity resonance through very high frequency forcing. AIAA Paper 2000-1905.
- [5] Stanek M.J., Ross J.A., Odredra J., Peto J.W. (2003) The mystery of the rod-in-crossflow revealed. AIAA Paper 2003-0007
- [6] Stanek M.J., Raman G., Ross J.A., Odredra J., Peto J.W., Alvi F., Kibens V. (2002) High frequency acoustic suppression-The role of mass flow, the notion of superposition, and the role of inviscid instability - a new model (part II). AIAA Paper 2003-0007.
- [7] Wiltse J.M. and Glezer A. (1998) Direct excitation of small-scale motions in free shear flows. Phys. Fluids, Vol. 10, No. 8, pp.2026-2036
- [8] Deron R., Illy H., Geffroy P., Mendez F. and Corbel B. Effects of a cavity flow passive control on optical phase degradations. AIAA Paper 2005-4659, 36th AIAA Plasmadynamics and laser conference, Toronto, Ontario Canada, June (2005).

- [9] Illy H., Geffroy P. et Jacquin L. Contrôle des oscillations de cavité au moyen d'un cylindre placé transversalement l'écoulement. 17<sup>me</sup> Congrès Français de mécanique, Troyes, Septembre (2005)
- [10] Illy H., Geffroy P. and Jacquin L. Control of Flow Oscillations over a Cavity by Means of a Spanwise Cylinder. XXI International Congress of Theoretical and Applied Mechanics Warsaw, Poland, August (2004)
- [11] Arunajatesan S., Shipman J.D. and Sinha N. Hybrid RANS-LES simulation of cavity flow fields with control. AIAA-2002- 1130 (2002).
- [12] El Hassan M., Keirsbulck L., Labraga L. Non-oscillating/oscillating shear layer over a deep cavity at low-subsonic speeds. *Flow, turbulence and combustion*, 82(3), 359-374, (2009).
- [13] Keirsbulck L., El Hassan M., Lippert M. and Labraga L. Control of cavity tones using a spanwise cylinder. *Can. J. Phys./Rev. can. phys.*, 86(12), 1355-1365, (2008).
- [14] J. Westerweel, *Digital Particle Image Velocimetry*. Delft University Press (1993).
- [15] A. Prasad, R. Adrian, C. Landreth and P. Offutt, Effect of resolution on the speed and accuracy of particle image velocimetry interrogation. *Experiments in Fluids* 13 105-116 (1992).
- [16] El Hassan M., Keirsbulck L. and Labraga L. "Aero-acoustic coupling inside large deep cavities at low-subsonic speeds" *Journal of Fluid Engineering*, 131(1), 011204, (2009).
- [17] Ho C-M and Huang L-S. Subharmonics and vortex merging in mixing layers. *J. Fluid Mech.* 119:443-473 (1982).
- [18] Gharib M. and Roshko A. The effect of flow oscillations on cavity drag. *Journal of Fluid Mech.* 177:501-530 (1987).
- [19] Forestier N., Jacquin L., Geffroy P. The mixing layer over a deep cavity at high-subsonic speed. *J. Fluid Mech.* 475:101-145 (2003).
- [20] Levasseur V., Sagaut P., Mallet M. and Chalot F. Unstructured Large Eddy Simulation of the passive control of the flow in a wapon bay. *Journal of fluids and structures*, 24(8), 1204-1216 (2008).