



HAL
open science

Design and analysis of dual band star shape slotted patch antenna

Souheyla Ferouani, Zhor Bendahmane, Abdelmalik Taleb-Ahmed

► **To cite this version:**

Souheyla Ferouani, Zhor Bendahmane, Abdelmalik Taleb-Ahmed. Design and analysis of dual band star shape slotted patch antenna. *Microwave Review*, 2017, 23 (1), pp.9-13. hal-03666409

HAL Id: hal-03666409

<https://uphf.hal.science/hal-03666409v1>

Submitted on 29 Nov 2024

HAL is a multi-disciplinary open access archive for the deposit and dissemination of scientific research documents, whether they are published or not. The documents may come from teaching and research institutions in France or abroad, or from public or private research centers.

L'archive ouverte pluridisciplinaire **HAL**, est destinée au dépôt et à la diffusion de documents scientifiques de niveau recherche, publiés ou non, émanant des établissements d'enseignement et de recherche français ou étrangers, des laboratoires publics ou privés.

Design and Analysis of Dual Band Star Shape Slotted Patch Antenna

Souheyla S. Ferouani¹, Zhor Z. Bendahmane¹, Abdelmalik A. Taleb Ahmed²

Abstract – This article proposes a new dual-band patch antenna for applications in the wireless local area network (WLAN) using MIMO technology. It consists on star shape slotted microstrip patch antenna, using FR4 substrate. The rectangular slotted patch uses microstrip feed line of 50 Ω characteristic impedance. This designed antenna can operates at 2.4 and 5 GHz resonant frequency. The dual band characteristic is obtained by integration of two open or partial star-shaped slots on the upper side of the patch and the third star slot is embedded in the center of the patch. In order to optimize characteristics of this patch antenna, “Computer Simulation Technology” Software (CST) is used. The results of simulations show that the proposed antenna covers the operating bands of 2.41 GHz (2.38-2.45 GHz) and 5.075 GHz (4.98-5.16 GHz), with return loss $S_{11} < -10\text{dB}$, also it presents a good omnidirectional radiation pattern, who meets the requirement of WLAN applications.

Keywords – Microstrip patch antenna, Microstrip feed line, Impedance matching, WLAN, Slots, Star shape slot, Return loss, radiation pattern, CST.

I. INTRODUCTION

Printed antennas are very suitable and effective for design requirements, especially because of their low profile and wide bandwidth. Furthermore they are easy to integrate with radio circuitry and to mount on printed circuit board [1-3]. Several slot shape models were performed and among these configurations, we focused on star shaped slot which is formed by eight corners that can be easily obtained by combining two squares of the same lengths; the second square is deviated from the first one of an angle of 45°. This kind of shape presents some advantages in microstrip patch antenna design, because of the ease of calculating its geometric characteristics; no design formulation study for star shape slots is needed and only geometric associations are examined [4]. The mathematical model equations associated to the rectangular patch design essentially predicts the resonant frequency [5]. It allows the calculation of the dimensions of the patch at 2.4 GHz. Additional star slots to the radiating element allow us to achieve a second resonance of 5 GHz, this later frequency is suitable to requirement of WLAN applications. In order to find the right dimensions and suitable

positions of the slots, several simulations were carried out using the “computer simulation technology software” (CST) which is essentially based on the Finite Integration Technique (FIT). The electrical parameter of the antenna such as return loss, radiation pattern and VSWR are investigated.

II. RECTANGULAR ANTENNA GEOMETRY

The basic structure is rectangular microstrip patch of initial dimensions corresponding to a resonant frequency of 2.4GHz (Fig. 1) [6]. Generally this structure consists in three layers and the bottom layer consists in metal conductor called ground plane covering the complete structure. Its dimensions are given according the following equations [7]:

$$L_g = 6 \cdot h + L_0, \quad (1)$$

$$W_g = 6 \cdot h + W_0, \quad (2)$$

where h is the height of the substrate, L_0 and W_0 are the length and the width of the rectangular patch, respectively.

The layer in the middle is FR4 Epoxy dielectric substrate; it covers the entire ground surface. This layer has thickness of 1.6mm, relative permittivity $\epsilon_r = 4.4$ and dielectric loss tangent of 0.025. Effective dielectric constant of the microstrip patch antenna can be computed from the following relation [8]:

$$\epsilon_{reff} = \frac{\epsilon_r + 1}{2} + \frac{\epsilon_r - 1}{2} \cdot \left(1 + 12 \cdot \frac{h}{w_0}\right)^{-\frac{1}{2}}. \quad (3)$$

The top of the substrate is a metal patch with the following dimensions [8]:

$$W_0 = \frac{c}{2f \cdot \sqrt{\frac{\epsilon_r + 1}{2}}}, \quad (4)$$

$$L_{eff} = \frac{c}{2f \cdot \sqrt{\epsilon_{reff}}}, \quad (5)$$

$$\Delta L = 0.412 \cdot h \cdot \frac{(\epsilon_{reff} + 0.3) \cdot \left(\frac{w_0}{h} + 0.246\right)}{(\epsilon_{reff} - 0.258) \cdot \left(\frac{w_0}{h} + 0.8\right)}, \quad (6)$$

$$L_0 = L_{eff} - 2 \cdot \Delta L, \quad (7)$$

¹Souhila S.Ferouani and Zhor Z. Bendahmane are members in the Intelligent Structure Laboratory, Belhadj Bouchaib University, Ain Temouchent, DGRSDT 46000, Algeria.

E-mails: souhilaferouani@gmail.com, zh_bendahmane@yahoo.fr

²Abdelmalik A.Taleb Ahmed is member in LAMIH Laboratory, Valenciennes University, UMR CNRS 8201, France, E-mail: taleb@univ-valenciennes.fr

where c is velocity of light in free space and f is the operating resonant frequency.

To achieve this antenna dimensions, the ground plane and substrate have the size of 6.4cm and 6.2cm in two dimensional planes respectively. The details of all geometrical parameters are given in Table 1.

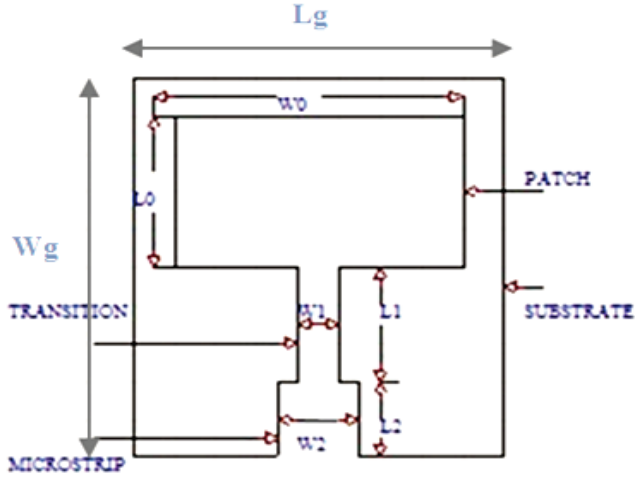

Fig. 1. Antenna geometry

TABLE 1
DESIGN PARAMETERS OF THE RECTANGULAR MICROSTRIP PATCH ANTENNA

Parameters	Values [mm]
h	1.60
L_0	28.00
W_0	37.26
L_1	17.45
W_1	1.10
L_2	15.0
W_2	2.98
ϵ_{reff}	4.10
ΔL	0.738
L_{eff}	29.38

III. SIMULATED RESULTS OF THE RECTANGULAR ANTENNA

We report on the Fig. 2, the variation of the S-parameter magnitude (dB) as function of the frequency (GHz), corresponding to the basic shape patch. As it can be seen, the return loss curve shows three resonating bands which are 2.415 GHz with -29.20 dB return loss, 3.63 GHz with -11.10 dB and 4.62 GHz with -26.22 dB.

The voltage standing wave ratio VSWR indicates the impedance matching between the field and the load. Fig. 3 shows the VSWR curve corresponding to the rectangular antenna, as a function of the frequency. We observed that the antenna reached suitable values of VSWR which are 1.07, 1.77 and 1.10 corresponding to frequencies respectively

2.415, 3.63 and 4.62 GHz. This antenna presents a good impedance matching for two frequencies 2.41GHz and 4.62 GHz. The minimum VSWR is 1.0, that means no power is reflected from the antenna in this case, which is ideal but not realizable, practically [6].

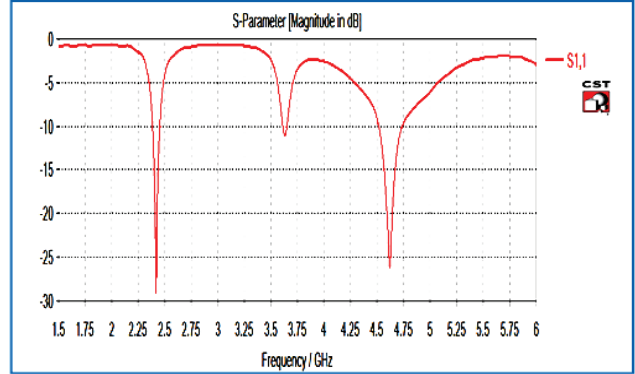

Fig. 2. Return loss of rectangular antenna

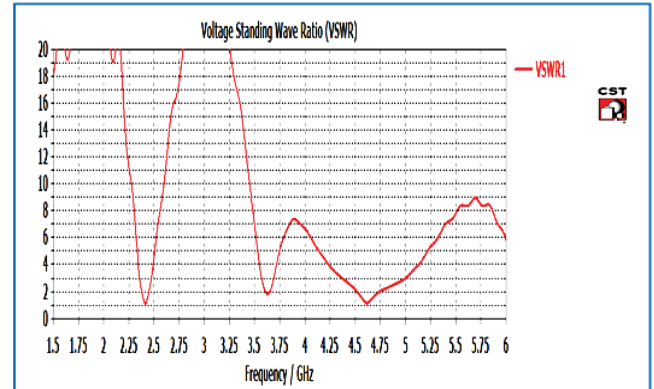

Fig. 3. VSWR of rectangular antenna

The radiation pattern characterizes the variation of the radiation intensity at large distance in different directions of space [9]. Figs. 4a and 5a show the far-field 3D- radiation patterns, which are nearly omnidirectional and present the gain of 6.59 dBi at 2.41GHz and 7.46 dBi at 4.62 GHz. From the polar radiation patterns (Figs. 4b and 5b), we can see that the angular width at 3 dB is 88.5° at 2.41GHz and 58.4° at 4.62 GHz.

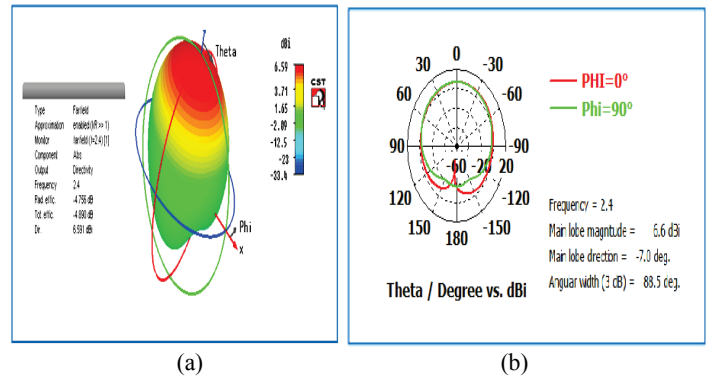

Fig. 4. 3D and polar radiation pattern at 2.41GHz

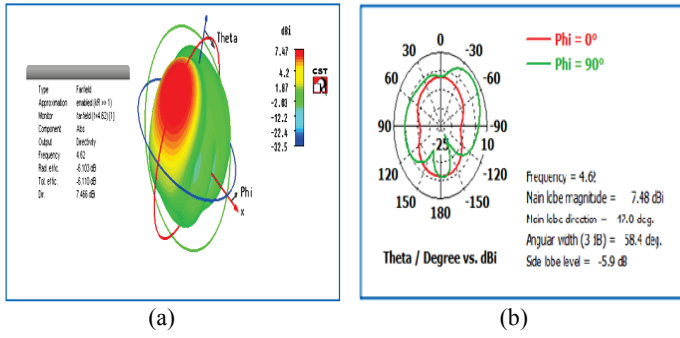

Fig. 5. 3D and Polar Radiation pattern at 4.62 GHz

IV. DUAL BAND ANTENNA WITH STAR SHAPED SLOTS

We observe that this rectangular antenna, designed to operate at a resonance frequency of 2.41 GHz, has a good bandwidth of 70 MHz. This band can cover the IEEE 801.11 b and g standards and offered already a dual band behavior. We opted to integrate the slots on the patch in order to achieve a second frequency of 5 GHz; this later can be used for the IEEE 801.11n standard.

A. Shape of Slot

Fig. 6 illustrates the star slot shape formed by eight corners. This configuration is obtained by combining two same dimension squares having length C . The second square is oriented with an angle of 45° regarding to the first square.

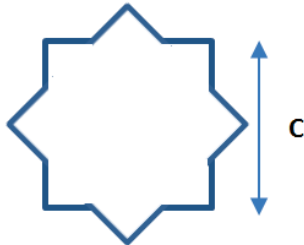

Fig. 6. Star Slot shape

B. Antenna with Two Partial Slots

Two identical partial slots are etched and aligned at the upper side of the simple reference patch using the star shape as shown in Fig. 6 with $C_1=10\text{mm}$ (Fig. 7). d represents the distance between the two notches and p is the penetration of the latter at the upper side of the radiating element. In order to obtain band frequency of 5 GHz, parametric studies were carried on the parameters p and d .

V. NOVEL ANTENNA DESIGN AND RESULTS

A. Parametric Study on p

First, we have fixed the distance between the notches d at 8 mm and we have varied the penetration of the notches p .

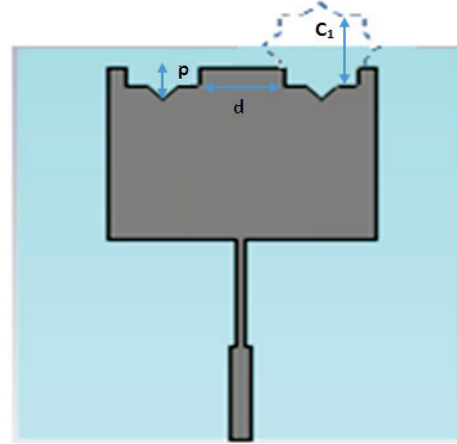

Fig. 7. Rectangular antenna with two star slots

Table 2 shows the resonance frequency values with their return loss $S[1,1]$ for different values of p .

TABLE 2
PARAMETRIC STUDY ON p

p (mm)	5	4	3
f_1 (GHz)	2,605	2,560	2,525
$S[1,1]$ (dB)	-25,55	-26,83	-27,38
f_2 (GHz)	4,980	4,975	4,960
$S[1,1]$ (dB)	-16,70	-15,66	-14,50

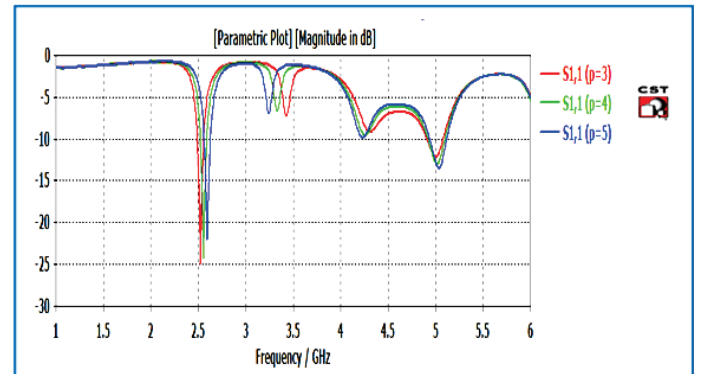

Fig. 8. The return loss of antenna with different values of p

The return loss curves as function of frequency for different values of penetration ($p = 5, 4, 3$ mm) are reported in Fig. 8. As shown in Fig. 8, the results confirm that this antenna has two reflection coefficients less than -10 dB corresponding to frequencies approaching the two bands [2.4, 5] GHz. The decrease in the penetration (p) leads to a decrease in the resonance frequencies for the two bands with a slight increase in the S-factor [1,1] corresponding to the 2.4 GHz band. This effect is advantageous for this later band since in fact this frequency is slightly higher than 2.4 GHz band. Concerning

the second band of 5GHz, in fact we have interest to cause an increase in the resonant frequency, for this we will vary the distance (d) between the slots and see its effect on the second frequency band.

B. Parametric Study on d

Concerning this second part of study, we fixed penetration slits p to 3 mm, and we have varied the distance (d) between the two notches. The reflection coefficients for different values of d are plotted on the Fig. 9. The results of variation of the parameter d are reported in Table 3.

TABLE 3
PARAMETRIC STUDY ON d

d (mm)	8	10	12
f_1 (GHz)	2,525	2,525	2,520
S[1,1] (dB)	-27,38	-26,53	-24,66
f_2 (GHz)	4,96	4,975	5
S[1,1] (dB)	-14,50	-13,11	-12,20

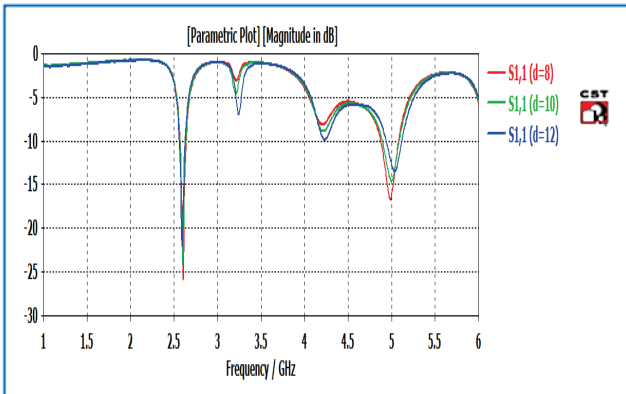

Fig. 9. Reflection coefficient for different values of d

As can be seen in Fig. 9, by moving the slots and increasing the distance between them we have a degradation of the return loss thus impedance matching for both frequency bands. However, there is a slight decrease resonant frequency at the 2.4 GHz band and an increase of the frequency band for the 5 GHz.

Until now the results of the simulation are moving well towards our objectives, but we must find a solution for level adjustment of return loss of the antenna.

C. Dual Band Antenna [2,4 – 5] GHZ

The proposed antenna has a rectangular radiating patch with dimensions $L_0 \times W_0$ printed on the same substrate as that used for simple reference antenna.

Three star slots are etched on this radiating element, two of them have the same length side $C_1 = 10$ mm and are opened

and aligned at the upper side of the patch with a spacing $d = 8$ mm, the penetration of the stars shaped is $p = 3$ mm. The third star slot with length side $C_2 = 7.5$ mm is positioned at the center of the patch as shown in Fig. 10. The centered slot allows us to improve the S[1,1] parameter of the antenna at the two band frequency. Fig. 11 represents the photograph of the antenna fabricated using the LPKF protomat H100.

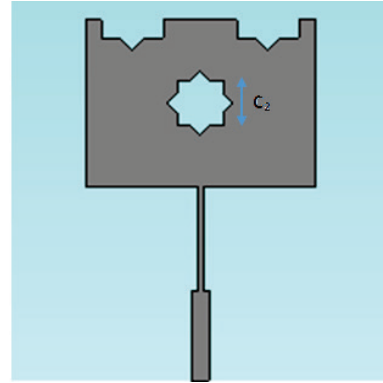

Fig. 10. Proposed antenna geometry

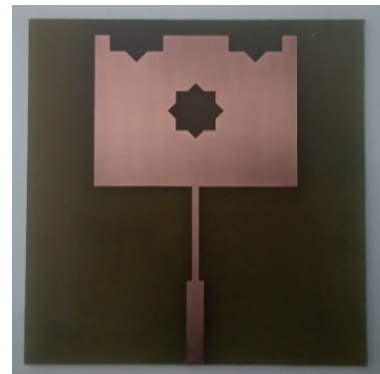

Fig. 11. Photograph of proposed antenna geometry

D. Result and Discussion

We reports in the Fig. 12 the variation of return loss as function of frequency corresponding to the designed slotted patch antenna (Fig. 10). The return loss curve shows two reflection coefficients S[1,1] less than -10 dB at the two operating frequency at 2.41 GHz and 5.075 GHz, that reveals the dual band behavior.

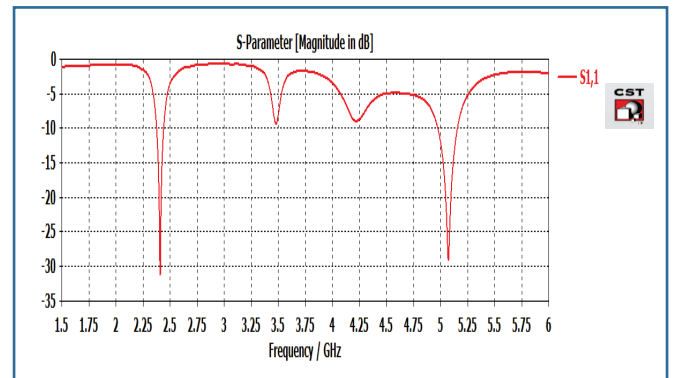

Fig. 12. Reflection coefficient of designed slotted patch antenna

VI. CONCLUSION

Table 4 below contains the results of reflection coefficient which confirms a good impedance matching of the antenna at the two resonating frequencies, the bandwidth which can be calculated from the S11 (dB) plot at -10dB, and from the VSWR values we can see the good agreement for the resonant frequencies.

TABLE 4
REFLECTION COEFFICIENT

Frequencies (GHz)	2,41	5,075
S11 (dB)	- 31 ,75	- 29,07
BW (MHz)	65	175
VSWR	1,05	1,07

The 3D radiation patterns of the designed antenna are illustrated in Fig. 13a and Fig. 14a at the two frequencies. The radiations are nearly Omni directional and show the positive gain of 6.6 dBi at 2.41 GHz and 7.93 dBi at 5.075 GHz. Therefore, we can say that this kind of antenna can be used as a transmitting as well as receiving antenna and it is able to cover all the WLAN bands. The Figs. 13b and 14b show the polar radiation patterns of the proposed antenna.

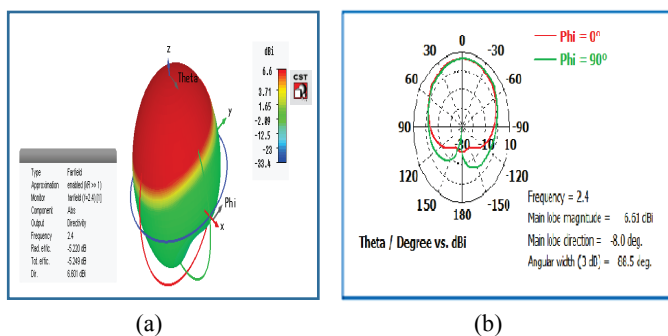

Fig. 13. 3D and Polar Radiation pattern of dual band antenna (at frequency 2.4 GHz)

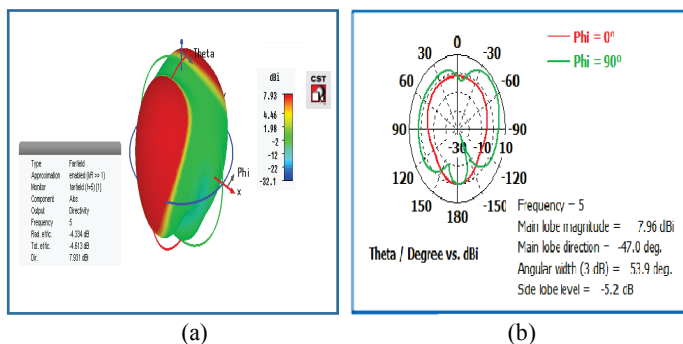

Fig. 14. Polar and 3D radiation pattern of dual band antenna (at frequency 5GHz)

This article proposes a novel dual-band patch antenna for satisfying the wireless local area network (WLAN). The design requirements are to meet the 2.4 GHz and 5 GHz bands. The proposed antenna consists of a rectangular patch printed antenna in which slotting technique is used to achieve dual band resonance. Three star shaped slots are integrated to the patch and are optimized to achieve proper dual band operation of the antenna.

The simulated results in terms of return loss, bandwidth, gain and VSWR indicate the suitability of the antenna for WLAN-IEEE- 802.11 and ISM bands. The proposed antenna is very simple in design and can be easily fabricated.

To achieve the compact feature of the proposed antenna and to facilitate its integration into radio circuitry, the miniaturization and eventually the frequency reconfiguration of the antenna are among the future priority of this work.

REFERENCES

- [1] D. Liu and B. Gaucher, "A New Multiband Antenna for WLAN/Cellular Applications", *IEEE Vehicular Technology Society Conference*, Milan, vol. 1, pp. 243-246, 2004.
- [2] C.-T. Lee and K.-L. Wong, "Uniplanar Printed Coupled-Fed PIFA With a Band-Notching Slit for WLAN/WiMax Operation in the Laptop Computer", *IEEE Trans. Antennas and Propagation*, vol. 57, pp. 1252-1258, 2009.
- [3] P. Misra and A. Tripathy, "A Novel Quad-band Printed Antenna Design using a Multi-Slotted Patch for Cellular Communication", *International Journal of Computer Applications*, vol. 63, no. 2, pp. 0975-8887, 2013.
- [4] D. Uzer and S. Gultekin, "A New Seljuk Star Shape Microstrip Patch Antenna Design", *Conference Proceedings PIERS*, Kuala Lumpur, Malaysia, Mars 27-30, 2012.
- [5] A. K. Arya, M. V. Kartikeyan and A. Patnaik, "Defected Ground Structure in the Perspective of Microstrip Antenna", *Frequenz*, vol. 64, pp.79-84, 2010.
- [6] O. M. Adegoke, and I. S. Eltoum, "Analysis and Design of Rectangular Microstrip Patch Antenna at 2.4 GHz WLAN Applications", *IJERT*, vol. 3 no. 8, 2014.
- [7] D. M. Pozar and D. H. Schaubert, *Microstrip Antennas: The Analysis and Design of Microstrip Antennas and Arrays*, John Wiley and Sons Inc, 1995.
- [8] A. Constantine and B. Balanis, *Antenna Theory Analysis and Design*, Second Edition, John Wiley and Sons, Inc, 1997.
- [9] K. Fujimoto, *Mobile Antenna Systems Handbook*, Artech House, 2008.