



HAL
open science

Fault estimation for nonlinear parameter-varying time-delayed systems

Márcia L.C. Peixoto, Pedro H.S. Coutinho, Tran Anh-Tu Nguyen,
Thierry-Marie Guerra, Reinaldo Palhares

► **To cite this version:**

Márcia L.C. Peixoto, Pedro H.S. Coutinho, Tran Anh-Tu Nguyen, Thierry-Marie Guerra, Reinaldo Palhares. Fault estimation for nonlinear parameter-varying time-delayed systems. Applied Mathematics and Computation, 2024, 465, pp.128405. 10.1016/j.amc.2023.128405 . hal-04278785

HAL Id: hal-04278785

<https://uphf.hal.science/hal-04278785v1>

Submitted on 25 Nov 2023

HAL is a multi-disciplinary open access archive for the deposit and dissemination of scientific research documents, whether they are published or not. The documents may come from teaching and research institutions in France or abroad, or from public or private research centers.

L'archive ouverte pluridisciplinaire **HAL**, est destinée au dépôt et à la diffusion de documents scientifiques de niveau recherche, publiés ou non, émanant des établissements d'enseignement et de recherche français ou étrangers, des laboratoires publics ou privés.

See discussions, stats, and author profiles for this publication at: <https://www.researchgate.net/publication/374910868>

Fault Estimation for Nonlinear Parameter-Varying Time-Delayed Systems

Article in *Applied Mathematics and Computation* · October 2023

CITATIONS

0

READS

111

5 authors, including:



Márcia Luciana da Costa Peixoto
Federal University of Minas Gerais

34 PUBLICATIONS 179 CITATIONS

SEE PROFILE



Pedro Henrique Silva Coutinho
Federal University of Minas Gerais

47 PUBLICATIONS 250 CITATIONS

SEE PROFILE



Anh-Tu Nguyen
Université Polytechnique Hauts-de-France

140 PUBLICATIONS 2,084 CITATIONS

SEE PROFILE



Thierry-Marie Guerra
Université Polytechnique Hauts-de-France

349 PUBLICATIONS 9,873 CITATIONS

SEE PROFILE

Fault Estimation for Nonlinear Parameter-Varying Time-Delayed Systems

Márcia L. C. Peixoto^a, Pedro H. S. Coutinho^a, Anh-Tu Nguyen^b,
Thierry-Marie Guerra^b, Reinaldo M. Palhares^{c,*}

^a*Federal University of Minas Gerais, Graduate Program in Electrical Engineering, Brazil*

^b*LAMIH UMR CNRS 8201, Université Polytechnique Hauts-de-France, France*

^c*Federal University of Minas Gerais, Department of Electronics Engineering, Brazil*

Abstract

A fault estimation method for a class of nonlinear parameter-varying systems subject to time-varying delay and unmeasured nonlinearities is presented. The unmeasured time-varying parameters are effectively handled using a sector-based condition approach. A gain-scheduling intermediate estimator is proposed to simultaneously estimate the system state and the unknown faults. Design conditions are derived based on Lyapunov–Krasovskii functional and integral inequality techniques. These conditions, expressed as linear matrix inequalities, ensure that the estimation error dynamics are input-to-state stable with respect to the time-derivative of the faults. Moreover, it is demonstrated that for the case of piecewise constant faults, the estimation error dynamics are exponentially stable. As a corollary result, conditions are also presented to design gain-scheduling intermediate estimators for nonlinear parameter-varying systems without time-varying delays. Three physically motivated examples are provided to demonstrate the effectiveness and practical interests of the proposed nonlinear estimation method.

Keywords: Fault estimation, nonlinear parameter-varying systems, time-varying delays, Lyapunov–Krasovskii functional, linear matrix inequalities.

*Corresponding author

Email addresses: marcialcpeixoto@gmail.com (Márcia L. C. Peixoto),
coutinho.p92@gmail.com (Pedro H. S. Coutinho), tnguyen@uphf.fr (Anh-Tu Nguyen),
guerra@uphf.fr (Thierry-Marie Guerra), rpalhares@ufmg.br (Reinaldo M. Palhares)

1. Introduction

Modern control systems require more sophisticated design requirements concerning safety, reliability, and maintainability. Possible occurrences of sensor and actuator faults can lead to closed-loop performance degradation or even instability [1, 2]. To this end, fault-tolerant control (FTC) techniques have been proposed to ensure desirable closed-loop requirements despite the presence of faults [3–5]. However, a key point for the correct operation of several FTC strategies is a well-designed fault detection and isolation (FDI) scheme, which is able to provide precise and correct information about the faults. Although FDI schemes are designed to provide residual signals to indicate the fault occurrence and the information of its type and location, the exact information about the magnitude and the shape of the fault cannot be obtained, which has motivated the development of fault estimation techniques to provide more precise information about the fault [6].

Within this context, observer-based fault estimation techniques have been widely studied, including sliding mode observers [7, 8], adaptive observers [9, 10], and unknown input observers [11, 12]. However, these techniques generally require the so-called matching condition to be satisfied, which may be restrictive, especially for nonlinear systems. To overcome this issue, Zhu et al. [6] have proposed the use of intermediate estimators to estimate both the states and the faults of nonlinear systems with Lipschitz nonlinearities. Other results concerning intermediate estimators have been derived for nonlinear systems with Lipschitz nonlinearities subject to stochastic faults [13], linear systems with multiple faults and disturbances [14], cooperative fault-tolerant tracking control of multi-agent systems [15], and attack reconstruction for cyber-physical systems [16]. However, the issue of intermediate estimator-based fault estimation has not been addressed for time-delayed (nonlinear) systems in the open literature.

Fault estimation results have been developed for time-delayed systems. Sliding mode observers have been proposed for state and parameter estimation of nonlinear time-delayed systems in [17], and for the estimation of sensor and actuator faults of time-delay Markov jump systems in [18]. Moreover, the fault diagnosis problem has been addressed for descriptor linear parameter varying (D-LPV) systems with time delay based on an adaptive polytopic observer [19]. However, for observer design, these results require well-known matching conditions. Without requiring specific matching conditions, a proportional multiple integral observer has been proposed to es-

40 timate both sensor and actuator faults of time-delayed Takagi-Sugeno (TS) fuzzy systems in [20]. Using the concept of intermediate estimators, the fault accommodation problem has been addressed by [21] for linear systems with time-varying delays, and by [22] for switched systems with time-varying delays. More recently, the actuator and sensor fault estimation problem has been also addressed for linear neutral-type systems in [23]. Most of the existing fault estimation results are related to linear systems and only a few
45 results are available for nonlinear time-delay systems, e.g., D-LPV systems or TS fuzzy systems. Accordingly, the first motivation of this work is to address the fault estimation problem for a class of nonlinear time-delayed systems using observers without requiring matching conditions.

This problem is addressed here regarding a polytopic embedding of non-
50 linear systems. It is known that nonlinear dynamical systems can be equivalently represented by polytopic quasi-LPV systems or TS fuzzy models [24]. However, although these representations are useful to derive constructive and numerically implementable conditions for designing observers [25], there is an important issue that should be accounted into the observer design, i.e., the
55 necessity to deal with unmeasured scheduling functions or premise variables in TS fuzzy systems. The results available for fault estimation and diagnosis for LPV systems [19] and TS fuzzy models [20] assume that the scheduling functions are measured or dependent on the output variables, which makes the design easier but limited to specific classes of nonlinear dynamical systems. To avoid this restriction, the second motivation of this work is to
60 provide constructive observer design conditions considering a polytopic representation of nonlinear time-delay systems with unmeasured nonlinearities.

For properly handling the unmeasured premise variables, the nonlinear system is rewritten as a TS fuzzy model with nonlinear consequent parts (N-
65 TS) [26–28]. Overall, the main advantage of the N-TS fuzzy models over the standard TS fuzzy models is the possibility to obtain a model with a fewer number of fuzzy rules, which reduces the representation’s complexity [26]. In the specific context of observer design, the N-TS fuzzy model provides a suitable alternative for handling the unmeasured premise variables by subsuming
70 the unmeasured terms in a local nonlinearity. Although this representation has shown to be effective for designing observers [27, 28] and unknown input observers [29] for N-TS fuzzy models, there are no results available for time-delay N-TS fuzzy models and N-LPV systems concerning fault estimation problems, which is the scope of this work.

75 This work addresses the fault estimation problem for a class of nonlinear

time-delay systems considering intermediate observers. The main contributions can be summarized as follows.

- A new class of gain-scheduling intermediate observers is proposed to simultaneously estimate the state and fault, without requiring matching conditions. Notice that results on intermediate observers are only available for linear time-delay systems [21, 23].
- Time-delay nonlinear systems are represented by a specific nonlinear parameter-varying (N-LPV) form, which allows circumventing the assumption of measured scheduling functions or premise variables in [19, 20].
- Constructive and numerically implementable conditions are derived in the form of linear matrix inequalities (LMIs) for gain-scheduling intermediate observer design such that the error dynamics is input-to-state stable (ISS) with respect to the fault time-derivative. A corollary result for N-LPV systems without time-varying delays is also presented.

This paper is organized as follows. The class of nonlinear time-delay parameter varying systems and the problem definition are described in Section 2. Section 3 presents the main results on gain-scheduling intermediate observer design. In Section 4, three numerical examples with physically motivated systems are presented to illustrate the interests of the proposed approach. Finally, Section 5 concludes the paper.

Notation. \mathbb{N} is the set of natural numbers and $\mathbb{N}_{\leq m}$ is the set of natural numbers less than or equal to m ; \mathbb{R}^n denotes the n -dimensional Euclidean space, and $\mathbb{R}^{m \times n}$ is the set of all $m \times n$ real matrices. \mathbb{S}_+^n is the set of symmetric and positive-definite matrices of order n . The notation $X \succ 0$ ($X \prec 0$) means that X is a positive (negative) definite matrix, and $\text{He}\{X\} = X + X^\top$. The identity matrix of order n is denoted by I_n and the null matrix of order $n \times m$ by $0_{n \times m}$. If the dimensions of both identity and null matrices are straightforwardly deduced, they are omitted. Let x be a vector, its i th entry is denoted by x_i . \mathcal{L}_∞ is the space of all essentially bounded functions whose norm is defined as $\|f\|_\infty = \text{ess sup}_{x \in [a,b]} |f(x)|$; the symbol \bullet in a matrix means that position can assume any value. $\text{diag}(A, B)$ denotes a block diagonal matrix whose elements are A and B . The time dependency of the variables is dropped when convenient.

110 **2. Problem Formulation**

This section first describes the class of nonlinear time-delay systems to be considered. Then, a nonlinear intermediate observer is constructed for its simultaneous estimation of system states and faults.

2.1. System Description

Consider a nonlinear parameter-varying system with time-varying delays

$$\begin{aligned} \dot{x}(t) &= F(\alpha(t), x(t)) + A_d(\alpha(t))x(t - \tau(t)) + h(y(t), u(t)) + Ef(t) \\ y(t) &= Cx(t) \\ x(t) &= \varphi(t), \quad t \in [-\underline{\tau}, 0], \end{aligned} \tag{1}$$

where $x \in \mathbb{R}^{n_x}$ is the state, $u \in \mathbb{R}^{n_u}$ is the input, $y \in \mathbb{R}^{n_y}$ is the output, $f \in \mathbb{R}^{n_f}$ is the fault signal, $\alpha = [\alpha_1, \alpha_2, \dots, \alpha_N]^\top \in \mathbb{R}^N$ is the vector of time-varying parameters, which are functions of *measured* exogenous signals and/or the output, and τ is a bounded time-varying delay. Moreover, φ is the initial condition and $F(\alpha, x) = A(\alpha)x + G(\alpha)\phi(x)$. Notice that the elements of the function $h(y, u)$ are all *measured*, and $\phi : \mathbb{R}^{n_x} \rightarrow \mathbb{R}^{n_\phi}$ is a function of *unmeasured* state variables. The parameter-dependent matrices $A(\alpha)$, $A_d(\alpha)$, and $G(\alpha)$ belong to a polytopic domain parameterized by the time-varying parameters $\alpha \in \Lambda$, defined as

$$[A(\alpha) \quad A_d(\alpha) \quad G(\alpha)] = \sum_{i=1}^N \alpha_i [A_i \quad A_{di} \quad G_i],$$

where N is the number of vertices of the polytopic domain, and the unit simplex Λ is given by

$$\Lambda = \left\{ \alpha \in \mathbb{R}^N : \sum_{i=1}^N \alpha_i = 1, \alpha_i \geq 0, i \in \mathbb{N}_{\leq N} \right\}. \tag{2}$$

115 The following assumptions are considered for system (1).

Assumption 1. *The time-varying delay $\tau(t)$ is known and satisfies $\underline{\tau} \leq \tau(t) \leq \bar{\tau}$, $\forall t \in \mathbb{R}$, where the lower bound $\underline{\tau}$ and the upper bound $\bar{\tau}$ are given.*

Assumption 2. *The fault signal $f(t)$ satisfies $\dot{f}(t) \in \mathcal{L}_\infty$, for $\forall t \in \mathbb{R}$, i.e., $\|\dot{f}(t)\|_\infty \leq \delta$, for some positive scalar δ .*

120 **Remark 1.** *The boundedness condition for time-varying delays in Assumption 1 is commonly considered in the literature on time-delayed systems [30], as delays in engineering applications always remain within their lower and upper bounds. Concerning Assumption 2, descriptor sliding mode observers such as those described in [8, 31] typically require prior knowledge of fault*
 125 *bounds and their derivatives. The adaptive observer presented in [9] also requires that both the faults and their first derivatives remain bounded. However, the parameter δ in Assumption 2 can be unknown. This flexibility enables us to handle a broad range of fault signals, including unbounded faults such as ramp-type faults. Consequently, Assumption 2 is less restrictive when*
 130 *compared to the fault constraints imposed in other related works [8, 9, 31].*

Assumption 3. *There exist positive constants k_{ij} , for $i \in \mathbb{N}_{\leq n_\phi}$, $j \in \mathbb{N}_{\leq n_x}$, such that*

$$0 \leq \frac{\partial \phi_i(x)}{\partial x_j} \leq k_{ij}, \quad i \in \mathbb{N}_{\leq n_\phi}, j \in \mathbb{N}_{\leq n_x}, \forall x \in \mathcal{D}, \quad (3)$$

where $\mathcal{D} \subseteq \mathbb{R}^{n_x}$ is a compact set containing the origin $x = 0$.

Remark 2. *Condition (3) is not restrictive for practical uses. Indeed, if we consider system (1) with $F(\alpha, x) = A(\alpha)x + G(\alpha)\tilde{\phi}(x)$, where $\tilde{\phi}(x)$ is any differentiable function with $\underline{k}_{ij} \leq \partial \tilde{\phi}_i(x)/\partial x_j \leq \bar{k}_{ij}$, for $\forall x \in \mathcal{D}$, and*
 135 *some scalars \underline{k}_{ij} and \bar{k}_{ij} . Applying a simple loop transformation $\phi(x) = \tilde{\phi}(x) - \underline{K}x$, where $\underline{K} = [\underline{k}_{ij}]$ is the element-wise lower bound of the Jacobian matrix $\partial \tilde{\phi}(x)/\partial x$, we have $F(\alpha, x) = (A(\alpha) + G(\alpha)\underline{K})x + G(\alpha)\phi(x)$. Then, condition (3) is satisfied with $k_{ij} = \bar{k}_{ij} - \underline{k}_{ij}$, and we can apply the same proposed observer design procedure in this case. This procedure is illustrated*
 140 *in the example shown in Section 4.2.*

2.2. Problem Definition

Let us define the following intermediate variable:

$$\zeta(t) = f(t) - \omega E^\top x(t), \quad (4)$$

where ω is a predefined positive scalar. From (1) and (4), the dynamics of the intermediate variable is defined as

$$\begin{aligned} \dot{\zeta}(t) = & -\omega E^\top E \zeta(t) - \omega E^\top [(A(\alpha) + \omega E E^\top) x(t) + h(y(t), u(t))] \\ & - \omega E^\top [A_d(\alpha)x(t - \tau(t)) + G(\alpha)\phi(x(t))] + \dot{f}(t). \end{aligned} \quad (5)$$

To estimate the state $x(t)$, the intermediate variable $\zeta(t)$, and the fault $f(t)$, we propose the following gain-scheduled intermediate observer:

$$\begin{aligned} \dot{\hat{x}}(t) &= A(\alpha)\hat{x}(t) + A_d(\alpha)\hat{x}(t - \tau(t)) + X(\alpha)^{-1}L(\alpha)(y(t) - \hat{y}(t)) \\ &\quad + h(y(t), u(t)) + E\hat{f}(t) + G(\alpha)\phi(\hat{x}(t) + H(\alpha)(y(t) - C\hat{x}(t))) \end{aligned} \quad (6)$$

$$\begin{aligned} \dot{\hat{\zeta}}(t) &= -\omega E^\top E\hat{\zeta}(t) - \omega E^\top \left[(A(\alpha) + \omega EE^\top) \hat{x}(t) + A_d(\alpha)\hat{x}(t - \tau(t)) \right. \\ &\quad \left. + h(y(t), u(t)) + G(\alpha)\phi(\hat{x}(t) + H(\alpha)(y(t) - C\hat{x}(t))) \right] \end{aligned} \quad (7)$$

$$\hat{y}(t) = C\hat{x}(t) \quad (8)$$

$$\hat{f}(t) = \hat{\zeta}(t) + \omega E^\top \hat{x}(t) \quad (9)$$

where $\hat{x}(t)$, $\hat{\zeta}(t)$, $\hat{y}(t)$ and $\hat{f}(t)$ are the estimates of $x(t)$, $\zeta(t)$, $y(t)$ and $f(t)$, respectively. The parameter-dependent matrices to be designed $X(\alpha)$, $L(\alpha)$ and $H(\alpha)$ are of the form

$$[X(\alpha) \quad L(\alpha) \quad H(\alpha)] = \sum_{i=1}^N \alpha_i [X_i \quad L_i \quad H_i]. \quad (10)$$

We define the estimation errors as

$$\varepsilon_x(t) = x(t) - \hat{x}(t), \quad (11)$$

$$\varepsilon_\zeta(t) = \zeta(t) - \hat{\zeta}(t), \quad (12)$$

$$\varepsilon_f(t) = f(t) - \hat{f}(t). \quad (13)$$

Then, the error dynamics can be represented by

$$\begin{aligned} \dot{\varepsilon}_x(t) &= (A(\alpha) - X(\alpha)^{-1}L(\alpha)C) \varepsilon_x(t) + A_d(\alpha)\varepsilon_x(t - \tau(t)) \\ &\quad + G(\alpha)g(\alpha, x, \varepsilon_x) + E\varepsilon_f(t) \\ \dot{\varepsilon}_\zeta(t) &= -\omega E^\top E\varepsilon_\zeta(t) - \omega E^\top (A(\alpha) + \omega EE^\top) \varepsilon_x(t) + \dot{f}(t) \\ &\quad - \omega E^\top A_d(\alpha)\varepsilon_x(t - \tau(t)) - \omega E^\top G(\alpha)g(\alpha, x, \varepsilon_x), \end{aligned} \quad (14)$$

where

$$g(\alpha, x, \varepsilon_x) = \phi(x) - \phi(\hat{x} + (I + H(\alpha)C)\varepsilon_x). \quad (15)$$

Let $\varepsilon(t) = [\varepsilon_x^\top(t) \quad \varepsilon_\zeta^\top(t)]^\top$ be the augmented error vector. Using the definition of the intermediate variable in (4), the error system (14) can be reformulated as follows

$$\dot{\varepsilon}(t) = \mathcal{A}(\alpha)\varepsilon(t) + \mathcal{A}_d(\alpha)\varepsilon(t - \tau(t)) + \mathcal{G}(\alpha)g(\alpha, x, \varepsilon_x) + \mathcal{B}\dot{f}(t), \quad (16)$$

where

$$\begin{aligned} \mathcal{A}(\alpha) &= \begin{bmatrix} A(\alpha) - X(\alpha)^{-1}L(\alpha)C + \omega EE^\top & E \\ -\omega E^\top (A(\alpha) + \omega EE^\top) & -\omega E^\top E \end{bmatrix} \\ \mathcal{A}_d(\alpha) &= \begin{bmatrix} A_d(\alpha) & 0 \\ -\omega E^\top A_d(\alpha) & 0 \end{bmatrix}, \quad \mathcal{G}(\alpha) = \begin{bmatrix} G(\alpha) \\ -\omega E^\top G(\alpha) \end{bmatrix}, \quad \mathcal{B} = \begin{bmatrix} 0 \\ \mathbf{I} \end{bmatrix}. \end{aligned}$$

Remark 3. *The proposed gain-scheduled intermediate observer introduced in (6)–(9) allows to deal with the simultaneous state and fault estimation without resorting to matching conditions, different from the sliding mode observers [7, 8, 31], adaptive observers [9, 10], and unknown input observers [11, 12]. Besides that, the proposed intermediate observer does not require any strict rank assumption over the system (1), constituting an effective solution to deal with the estimation problem for nonlinear time-delay systems.*

The estimation problem for the N-LPV system (1) is stated as follows.

Problem 1. *Consider the nonlinear parameter-varying time-delay system (1) under Assumptions 1–3. Design the parameter-dependent matrices $X(\alpha)$, $L(\alpha)$, and $H(\alpha)$ of the nonlinear intermediate observer (6)–(9) such that the error dynamics (16) is input-to-state stable (ISS) with respect to $\dot{f}(t)$.*

Further details regarding ISS stability can be found in [32, Chapter 4.9].

3. Nonlinear Intermediate Observer Design for Fault Estimation

This section presents the design of intermediate observers for N-LPV systems subject to faults. For observer design, the following lemma is useful to deal with the nonlinear function $\phi(x)$ by exploiting the sector condition and the boundedness of its Jacobian matrix as stated in Assumption 3.

Lemma 1 (Adapted from [33]). *Let $K = [K_1^\top \ K_2^\top \ \dots \ K_{n_\phi}^\top]^\top$, with $K_i = [k_{i1} \ k_{i2} \ \dots \ k_{in}]$, $i \in \mathbb{N}_{\leq n_\phi}$, with k_{ij} defined in Assumption 3. If the function $\phi(x) : \mathbb{R}^{n_x} \rightarrow \mathbb{R}^{n_\phi}$ satisfies Assumption 3, then the following sector condition holds for ε_x in (11) and $g(\alpha, x, \varepsilon_x)$ in (15):*

$$g(\alpha, x, \varepsilon_x)^\top [g(\alpha, x, \varepsilon_x) - K(\mathbf{I} + H(\alpha)C)\varepsilon_x] \leq 0. \quad (17)$$

Note that condition (17) can be represented in the following quadratic form

$$\begin{bmatrix} \varepsilon_x \\ g(\alpha, x, \varepsilon_x) \end{bmatrix}^\top \begin{bmatrix} \tilde{H}(\alpha)^\top & 0 \\ 0 & \mathbf{I} \end{bmatrix} \begin{bmatrix} 0 & -\frac{1}{2}K^\top \\ -\frac{1}{2}K & \mathbf{I} \end{bmatrix} \begin{bmatrix} \tilde{H}(\alpha) & 0 \\ 0 & \mathbf{I} \end{bmatrix} \begin{bmatrix} \varepsilon_x \\ g(\alpha, x, \varepsilon_x) \end{bmatrix} \leq 0$$

where $\tilde{H}(\alpha) = \mathbf{I} - H(\alpha)C$.

Remark 4. Regarding Assumption 3, since the function $\phi(x)$ possesses a bounded gradient with respect to x , the matrix norm of K , defined in Lemma 1, can be related to the Lipschitz constant. However, employing the Lipschitz property often results in overestimated bounds, introducing conservatism into the design procedure. In this paper, we have utilized the sector-bounded property, as stated in Lemma 1, to derive less conservative design conditions.

3.1. Time-Delay Nonlinear Parameter-Varying Systems

The following theorem provides LMI-based conditions to design an intermediate observer for system (1).

Theorem 1. Given positive scalars ϵ , β and ω , if there exist matrices $P \in \mathbb{S}_+^{3n_x}$, $Q_1, Q_2, R_1, R_2 \in \mathbb{S}_+^{n_x}$, $\Gamma \in \mathbb{S}_+^{n_f}$, matrices $Y_1, Y_2 \in \mathbb{R}^{2n_x \times 2n_x}$, $X_i \in \mathbb{R}^{n_x \times n_x}$, $H_i \in \mathbb{R}^{n_x \times n_y}$, $L_i \in \mathbb{R}^{n_x \times n_y}$, $F_{1i}, F_{2i} \in \mathbb{R}^{n_f \times n_f}$, and a positive scalar γ , such that following inequalities hold:

$$\begin{cases} \Theta_{ii}(\tau) \prec 0, & i = j \\ \Theta_{ij}(\tau) + \Theta_{ji}(\tau) \prec 0, & i < j \end{cases} \quad (18)$$

for all $i, j \in \mathbb{N}_{\leq N}$ and $\tau \in \{\underline{\tau}, \bar{\tau}\}$, with

$$\Theta_{ij}(\underline{\tau}) = \begin{bmatrix} \Psi(\underline{\tau}) - \mathcal{H}_j + \text{He}\{\Upsilon_{ij} + \Pi_{ij}\} - e^{-2\beta\bar{\tau}}\mathcal{G}^\top\Phi(\underline{\tau})\mathcal{G} & \star \\ [e^{-\beta\bar{\tau}}Y_1^\top & 0] \mathcal{G} & -\tilde{R}_2 \end{bmatrix}, \quad (19)$$

$$\Theta_{ij}(\bar{\tau}) = \begin{bmatrix} \Psi(\bar{\tau}) - \mathcal{H}_j + \text{He}\{\Upsilon_{ij} + \Pi_{ij}\} - e^{-2\beta\bar{\tau}}\mathcal{G}^\top\Phi(\bar{\tau})\mathcal{G} & \star \\ [0 & e^{-\beta\bar{\tau}}Y_2^\top] \mathcal{G} & -\tilde{R}_2 \end{bmatrix}. \quad (20)$$

The matrices $\Psi(\tau)$ and $\Phi(\tau)$, with $\tau \in \{\underline{\tau}, \bar{\tau}\}$, are defined as

$$\begin{aligned} \Psi(\tau) &= G_1^\top(\tau)PG_0 + G_0^\top PG_1(\tau) + 2\beta G_1^\top(\tau)PG_1(\tau) - e^{-2\beta\tau}G_2^\top\tilde{R}_1G_2 \\ &\quad + G_0^\top(\underline{\tau}^2\hat{R}_1 + \tilde{\tau}^2e^{-2\beta\tilde{\tau}}\hat{R}_2)G_0 + G_5^\top\tilde{\Gamma}G_5 + \tilde{v}_2^\top 2\beta\Gamma\tilde{v}_2 + \tilde{Q} + \mathcal{F}, \\ \Phi(\tau) &= \begin{bmatrix} \tilde{R}_2 & 0 \\ 0 & \tilde{R}_2 \end{bmatrix} + \frac{\bar{\tau}-\tau(t)}{\tilde{\tau}} \begin{bmatrix} \tilde{R}_2 & Y_2 \\ Y_2^\top & 0 \end{bmatrix} + \frac{\tau(t)-\underline{\tau}}{\tilde{\tau}} \begin{bmatrix} 0 & Y_1 \\ Y_1^\top & \tilde{R}_2 \end{bmatrix}, \end{aligned} \quad (21)$$

where

$$\begin{aligned} \tilde{\tau} &= \bar{\tau} - \underline{\tau}, \\ \tilde{R}_1 &= \text{diag}(R_1, 3R_1), \quad \tilde{R}_2 = \text{diag}(R_2, 3R_2), \end{aligned}$$

$$\begin{aligned}
\widehat{R}_1 &= \text{diag}(R_1, 0_{2n_x}), & \widehat{R}_2 &= \text{diag}(R_2, 0_{2n_x}), \\
\widetilde{Q} &= \text{diag}(0_{n_x}, Q_1, e^{-2\beta\underline{\tau}}(Q_2 - Q_1), 0_{n_x}, -e^{-2\beta\overline{\tau}}Q_2, 0_{3n_x+3n_f+n_\phi}), \\
\mathcal{F} &= \text{diag}(0_{8n_x}, 0_{2n_f}, -\gamma I_{n_f}, 0_{n_\phi}), \\
\Upsilon_{ij} &= (\epsilon v_1 + v_2 + v_4)^\top (\mathcal{A}_{ij}v_2 + X_j A_{di}v_4 + X_j E \bar{v}_2 + X_j G_i \tilde{v} - X_j v_1), \\
\mathcal{A}_{ij} &= X_j A_i - L_j C + \omega X_j E E^\top, \\
\Pi_{ij} &= (F_{1j} \bar{v}_1 + F_{2j} \bar{v}_2)^\top (\mathcal{E}_i - \bar{v}_1 + \bar{v}_3), \\
\mathcal{E}_i &= -\omega E^\top (E \bar{v}_2 + (A_i + \omega E E^\top) v_2 + A_{di} v_4 + G_i \tilde{v}), \\
G_1(\tau) &= \begin{bmatrix} v_2 \\ \underline{\tau} v_6 \\ (\tau(t) - \underline{\tau})v_7 + (\overline{\tau} - \tau(t))v_8 \end{bmatrix}, \\
G_0 &= \begin{bmatrix} v_1 \\ v_2 - v_3 \\ v_3 - v_5 \end{bmatrix}, \quad G_2 = \begin{bmatrix} v_2 - v_3 \\ v_2 + v_3 - 2v_6 \end{bmatrix}, \\
G_3 &= \begin{bmatrix} v_3 - v_4 \\ v_3 + v_4 - 2v_7 \end{bmatrix}, \quad G_4 = \begin{bmatrix} v_4 - v_5 \\ v_4 + v_5 - 2v_8 \end{bmatrix}, \\
G_5 &= \begin{bmatrix} \bar{v}_1 \\ \bar{v}_2 \end{bmatrix}, \quad \widetilde{\Gamma} = \begin{bmatrix} 0 & \Gamma \\ \Gamma & 0 \end{bmatrix}, \quad \mathcal{G} = \begin{bmatrix} G_3 \\ G_4 \end{bmatrix}, \\
v_\kappa &= \begin{bmatrix} 0_{n_x \times (\kappa-1)n_x} & I_{n_x} & 0_{n_x \times (8-\kappa)n_x} & 0_{n_x \times 3n_f} & 0_{n_x \times n_\phi} \end{bmatrix}, \\
\bar{v}_l &= \begin{bmatrix} 0_{n_f \times 8n_x} & 0_{n_f \times (1-l)n_f} & I_{n_f} & 0_{n_f \times (3-l)n_f} & 0_{n_f \times n_\phi} \end{bmatrix}, \\
\tilde{v} &= \begin{bmatrix} 0_{n_\phi \times (8n_x+3n_f)} & I_{n_\phi} \end{bmatrix}, \\
\mathcal{H}_j &= \begin{bmatrix} v_2 \\ \tilde{v} \end{bmatrix}^\top \begin{bmatrix} I - H_j C & 0 \\ 0 & I \end{bmatrix}^\top \begin{bmatrix} 0 & \frac{-K^\top}{2} \\ \frac{-K}{2} & I \end{bmatrix} \begin{bmatrix} I - H_j C & 0 \\ 0 & I \end{bmatrix} \begin{bmatrix} v_2 \\ \tilde{v} \end{bmatrix},
\end{aligned} \tag{22}$$

with $\kappa \in \mathbb{N}_{\leq 8}$ and $l \in \mathbb{N}_{\leq 3}$. Then, the intermediate observer (6)–(9), with the parameter-dependent gains given as in (10), ensures that the error system (16) is ISS with respect to $\dot{f}(t)$. Moreover, the ellipsoid

$$\mathcal{R}_\infty = \left\{ \varepsilon_x \in \mathbb{R}^{n_x}, \varepsilon_\zeta \in \mathbb{R}^{n_f} : \varepsilon_x^\top \bar{P} \varepsilon_x + \varepsilon_\zeta^\top \Gamma \varepsilon_\zeta \leq \frac{\gamma \delta^2}{2\beta} \right\}, \tag{23}$$

170 is attractive with respect to system (16), where $\bar{P} = U P U^\top$ and $U = [I \ 0 \ 0]$.

Proof. For stability analysis, consider the proposed Lyapunov-Krasovskii functional (LKF) candidate given by

$$V(\varepsilon_{x_t}, \dot{\varepsilon}_{x_t}, \varepsilon_{\zeta_t}, t) = V_1(\varepsilon_{x_t}, t) + V_2(\varepsilon_{x_t}, t) + V_3(\dot{\varepsilon}_{x_t}, t) + V_4(\varepsilon_\zeta, t) \tag{24}$$

with

$$\begin{aligned}
V_1(\varepsilon_{x_t}, t) &= \begin{bmatrix} \varepsilon_x(t) \\ \int_{t-\underline{\tau}}^t \varepsilon_x(s) ds \\ \int_{t-\bar{\tau}}^{t-\underline{\tau}} \varepsilon_x(s) ds \end{bmatrix}^\top P \begin{bmatrix} \varepsilon_x(t) \\ \int_{t-\underline{\tau}}^t \varepsilon_x(s) ds \\ \int_{t-\bar{\tau}}^{t-\underline{\tau}} \varepsilon_x(s) ds \end{bmatrix} \\
V_2(\varepsilon_{x_t}, t) &= \int_{t-\underline{\tau}}^t e^{-2\beta(t-s)} \varepsilon_x^\top(s) Q_1 \varepsilon_x(s) ds + \int_{t-\bar{\tau}}^{t-\underline{\tau}} e^{-2\beta(t-s)} \varepsilon_x^\top(s) Q_2 \varepsilon_x(s) ds \\
V_3(\dot{\varepsilon}_{x_t}, t) &= \underline{\tau} \int_{-\underline{\tau}}^0 \int_{t+\theta}^t e^{-2\beta(t-s)} \dot{\varepsilon}_x^\top(s) R_1 \dot{\varepsilon}_x(s) ds d\theta \\
&\quad + \tilde{\tau} \int_{-\bar{\tau}}^{-\underline{\tau}} \int_{t+\theta}^t e^{-2\beta(t-s)} \dot{\varepsilon}_x^\top(s) R_2 \dot{\varepsilon}_x(s) ds d\theta \\
V_4(\varepsilon_\zeta, t) &= \varepsilon_\zeta^\top(t) \Gamma \varepsilon_\zeta(t)
\end{aligned}$$

and $\tilde{\tau} = \bar{\tau} - \underline{\tau}$. Since the matrices P , Q_1 , Q_2 , R_1 and R_2 are positive definite, the LKF candidate defined in (24) is also positive definite. Consider the augmented vector

$$\xi(t) = \left[\tilde{\xi}(t) \quad \nu_1^\top(t) \quad \nu_2^\top(t) \quad \nu_3^\top(t) \quad \dot{\varepsilon}_\zeta^\top(t) \quad \varepsilon_\zeta^\top(t) \quad \dot{f}^\top(t) \quad g^\top(\alpha, x, \varepsilon_x) \right]^\top \quad (25)$$

with

$$\begin{aligned}
\tilde{\xi}(t) &= \left[\dot{\varepsilon}_x^\top(t) \quad \varepsilon_x^\top(t) \quad \varepsilon_x^\top(t - \underline{\tau}) \quad \varepsilon_x^\top(t - \tau(t)) \quad \varepsilon_x^\top(t - \bar{\tau}) \right] \\
\nu_1(t) &= \frac{1}{\underline{\tau}} \int_{t-\underline{\tau}}^t \varepsilon_x(s) ds \\
\nu_2(t) &= \frac{1}{\tau(t) - \underline{\tau}} \int_{t-\tau(t)}^{t-\underline{\tau}} \varepsilon_x(s) ds \\
\nu_3(t) &= \frac{1}{\bar{\tau} - \tau(t)} \int_{t-\bar{\tau}}^{t-\tau(t)} \varepsilon_x(s) ds.
\end{aligned} \quad (26)$$

The time-derivative of $V_1(\varepsilon_{x_t}, t)$ along the solution of system (14) is given by

$$\dot{V}_1(\varepsilon_{x_t}, t) = \xi^\top(t) \left(G_1^\top(\tau) P G_0 + G_0^\top P G_1(\tau) \right) \xi(t). \quad (27)$$

The expression of $\dot{V}_2(\varepsilon_{x_t}, t)$ can be computed as

$$\begin{aligned}
\dot{V}_2(\varepsilon_{x_t}, t) &= \varepsilon_x^\top(t)Q_1\varepsilon_x(t) + \varepsilon_x^\top(t - \underline{\tau})e^{-2\beta\underline{\tau}}(Q_2 - Q_1)\varepsilon_x(t - \underline{\tau}) \\
&\quad - \varepsilon_x^\top(t - \bar{\tau})e^{-2\beta\bar{\tau}}Q_2\varepsilon_x(t - \bar{\tau}) \\
&\quad - 2\beta \int_{t-\underline{\tau}}^t e^{-2\beta(t-s)}\varepsilon_x^\top(s)Q_1\varepsilon_x(s)ds - 2\beta \int_{t-\bar{\tau}}^{t-\underline{\tau}} e^{-2\beta(t-s)}\varepsilon_x^\top(s)Q_2\varepsilon_x(s)ds \\
&= \xi^\top(t)\tilde{Q}\xi(t) - 2\beta V_2(\varepsilon_{x_t}, t). \tag{28}
\end{aligned}$$

The computation of $\dot{V}_3(\dot{\varepsilon}_{x_t}, t)$ results in

$$\begin{aligned}
\dot{V}_3(\dot{\varepsilon}_{x_t}, t) &= \dot{\varepsilon}_x^\top(t)(\underline{\tau}^2 R_1 + \tilde{\tau}^2 e^{-2\beta\tilde{\tau}} R_2)\dot{\varepsilon}_x(t) \\
&\quad - \underline{\tau} \int_{t-\underline{\tau}}^t e^{-2\beta(t-s)}\dot{\varepsilon}_x^\top(s)R_1\dot{\varepsilon}_x(s)ds - \tilde{\tau} \int_{t-\bar{\tau}}^{t-\underline{\tau}} e^{-2\beta(t-s)}\dot{\varepsilon}_x^\top(s)R_2\dot{\varepsilon}_x(s)ds \\
&\quad - 2\beta\underline{\tau} \int_{-\underline{\tau}}^0 \int_{t+\theta}^t e^{-2\beta(t-s)}\dot{\varepsilon}_x^\top(s)R_1\dot{\varepsilon}_x(s)dsd\theta \\
&\quad - 2\beta\tilde{\tau} \int_{-\bar{\tau}}^{-\underline{\tau}} \int_{t+\theta}^t e^{-2\beta(t-s)}\dot{\varepsilon}_x^\top(s)R_2\dot{\varepsilon}_x(s)dsd\theta. \tag{29}
\end{aligned}$$

From the definition of the matrix G_0 , expression (29) can be rewritten as

$$\begin{aligned}
\dot{V}_3(\dot{\varepsilon}_{x_t}, t) &= \xi^\top(t)G_0^\top(\underline{\tau}^2 \hat{R}_1 + \tilde{\tau}^2 e^{-2\beta\tilde{\tau}} \hat{R}_2)G_0\xi(t) \\
&\quad - \underline{\tau} \int_{t-\underline{\tau}}^t e^{-2\beta(t-s)}\dot{\varepsilon}_x^\top(s)R_1\dot{\varepsilon}_x(s)ds - \tilde{\tau} \int_{t-\bar{\tau}}^{t-\underline{\tau}} e^{-2\beta(t-s)}\dot{\varepsilon}_x^\top(s)R_2\dot{\varepsilon}_x(s)ds \\
&\quad - 2\beta\underline{\tau} \int_{-\underline{\tau}}^0 \int_{t+\theta}^t e^{-2\beta(t-s)}\dot{\varepsilon}_x^\top(s)R_1\dot{\varepsilon}_x(s)dsd\theta \\
&\quad - 2\beta\tilde{\tau} \int_{-\bar{\tau}}^{-\underline{\tau}} \int_{t+\theta}^t e^{-2\beta(t-s)}\dot{\varepsilon}_x^\top(s)R_2\dot{\varepsilon}_x(s)dsd\theta. \tag{30}
\end{aligned}$$

According to the Wirtinger-based integral inequality (see Lemma 2 in

Appendix A), it follows from (30) that

$$\begin{aligned}
\dot{V}_3(\dot{\varepsilon}_{x_t}, t) &\leq \xi^\top(t)G_0^\top(\underline{\tau}^2\widehat{R}_1 + \tilde{\tau}^2e^{-2\beta\tilde{\tau}}\widehat{R}_2)G_0\xi(t) - e^{-2\beta\underline{\tau}}\xi^\top(t)G_2^\top\widetilde{R}_1G_2\xi(t) \\
&\quad - e^{-2\beta\tilde{\tau}}\xi^\top(t)\begin{bmatrix} G_3 \\ G_4 \end{bmatrix}^\top \begin{bmatrix} \frac{\tilde{\tau}}{\tau(t)-\underline{\tau}}\widetilde{R}_2 & 0 \\ 0 & \frac{\tilde{\tau}}{\overline{\tau}-\tau(t)}\widetilde{R}_2 \end{bmatrix} \begin{bmatrix} G_3 \\ G_4 \end{bmatrix} \xi(t) \\
&\quad - 2\beta\underline{\tau} \int_{-\underline{\tau}}^0 \int_{t+\theta}^t e^{-2\beta(t-s)}\dot{\varepsilon}_x^\top(s)R_1\dot{\varepsilon}_x(s)dsd\theta \\
&\quad - 2\beta\tilde{\tau} \int_{-\tilde{\tau}}^{-\underline{\tau}} \int_{t+\theta}^t e^{-2\beta(t-s)}\dot{\varepsilon}_x^\top(s)R_2\dot{\varepsilon}_x(s)dsd\theta. \tag{31}
\end{aligned}$$

Moreover, we define $\varrho = \frac{\tau(t)-\underline{\tau}}{\tilde{\tau}}$. Then, by employing the delay-dependent reciprocally convex lemma (see Lemma 3 in Appendix A) with $X_1 = \widetilde{R}_2 - Y_1\widetilde{R}_2^{-1}Y_1^\top$ and $X_2 = \widetilde{R}_2 - Y_2^\top\widetilde{R}_2^{-1}Y_2$, one has that

$$\begin{aligned}
\dot{V}_3(\dot{\varepsilon}_{x_t}, t) &\leq \xi^\top(t)G_0^\top(\underline{\tau}^2\widehat{R}_1 + \tilde{\tau}^2e^{-2\beta\tilde{\tau}}\widehat{R}_2)G_0\xi(t) - e^{-2\beta\underline{\tau}}\xi^\top(t)G_2^\top\widetilde{R}_1G_2\xi(t) \\
&\quad - 2\beta\underline{\tau} \int_{-\underline{\tau}}^0 \int_{t+\theta}^t e^{-2\beta(t-s)}\dot{\varepsilon}_x^\top(s)R_1\dot{\varepsilon}_x(s)dsd\theta \\
&\quad - 2\beta\tilde{\tau} \int_{-\tilde{\tau}}^{-\underline{\tau}} \int_{t+\theta}^t e^{-2\beta(t-s)}\dot{\varepsilon}_x^\top(s)R_2\dot{\varepsilon}_x(s)dsd\theta \\
&\quad - e^{-2\beta\tilde{\tau}}\xi^\top(t)\mathcal{G}^\top(\Phi(\tau) - \Phi_0(\tau))\mathcal{G}\xi(t), \tag{32}
\end{aligned}$$

where

$$\Phi_0(\tau) = \begin{bmatrix} \frac{\overline{\tau}-\tau(t)}{\tilde{\tau}}Y_1\widetilde{R}_2^{-1}Y_1^\top & 0 \\ 0 & \frac{\tau(t)-\underline{\tau}}{\tilde{\tau}}Y_2^\top\widetilde{R}_2^{-1}Y_2 \end{bmatrix}.$$

Finally, the computation of $\dot{V}_4(\varepsilon_{\zeta_t}, t)$ results in

$$V_4(\varepsilon_{\zeta_t}, t) = \xi^\top(t)G_5^\top\widetilde{\Gamma}G_5\xi(t). \tag{33}$$

Substituting the expressions of $\dot{V}_1(\varepsilon_{x_t}, t)$ in (27), $\dot{V}_2(\varepsilon_{x_t}, t)$ in (28), $\dot{V}_4(\varepsilon_{\zeta_t}, t)$ in (33) and the upper bound of $\dot{V}_3(\dot{\varepsilon}_{x_t}, t)$ in (32), into the expression of $\dot{V}(\varepsilon_{x_t}, \dot{\varepsilon}_{x_t}, \varepsilon_{\zeta_t}, t)$, it follows that

$$\dot{V}(\varepsilon_{x_t}, \dot{\varepsilon}_{x_t}, \varepsilon_{\zeta_t}, t) + 2\beta V(\varepsilon_{x_t}, \dot{\varepsilon}_{x_t}, \varepsilon_{\zeta_t}, t) \leq \xi^\top(t)\Xi(\tau)\xi(t), \tag{34}$$

with

$$\begin{aligned}\Xi(\tau) &= G_1^\top(\tau)PG_0 + G_0^\top PG_1(\tau) + 2\beta G_1^\top(\tau)PG_1(\tau) \\ &\quad + G_0^\top(\tau^2\widehat{R}_1 + \tilde{\tau}^2 e^{-2\beta\tilde{\tau}}\widehat{R}_2)G_0 - e^{-2\beta\tau}G_2^\top\widehat{R}_1G_2 \\ &\quad + G_5^\top\widetilde{\Gamma}G_5 + \bar{v}_2^\top 2\beta\Gamma\bar{v}_2 + \widetilde{Q} - e^{-2\beta\tilde{\tau}}\mathcal{G}^\top(\Phi(\tau) - \Phi_0(\tau))\mathcal{G}.\end{aligned}$$

Moreover, it follows from the sector condition (17) that

$$\xi^\top(t)\mathcal{H}(\alpha)\xi(t) \leq 0, \quad (35)$$

with

$$\mathcal{H}(\alpha) = \begin{bmatrix} v_2 \\ \tilde{v} \end{bmatrix}^\top \begin{bmatrix} \widetilde{H}(\alpha) & 0 \\ 0 & \mathbf{I} \end{bmatrix}^\top \begin{bmatrix} 0 & -\frac{1}{2}K^\top \\ -\frac{1}{2}K & \mathbf{I} \end{bmatrix} \begin{bmatrix} \widetilde{H}(\alpha) & 0 \\ 0 & \mathbf{I} \end{bmatrix} \begin{bmatrix} v_2 \\ \tilde{v} \end{bmatrix}.$$

Therefore, we have from (34) and (35) that

$$\dot{V}(\varepsilon_{x_t}, \dot{\varepsilon}_{x_t}, \varepsilon_{\zeta_t}, t) + 2\beta V(\varepsilon_{x_t}, \dot{\varepsilon}_{x_t}, \varepsilon_{\zeta_t}, t) \leq \xi^\top(t)(\Xi(\tau) - \mathcal{H}(\alpha))\xi(t). \quad (36)$$

Note that the following zero-equalities hold for any matrices $X(\alpha) \in \mathbb{R}^{n_x \times n_x}$, $F_1(\alpha) \in \mathbb{R}^{n_f \times n_f}$ and $F_2(\alpha) \in \mathbb{R}^{n_f \times n_f}$:

$$\Upsilon(\alpha)\xi(t) = 0 \quad \text{and} \quad \Pi(\alpha)\xi(t) = 0 \quad (37)$$

with

$$\begin{aligned}\Upsilon(\alpha) &= \mathcal{X}^\top(\alpha)\Upsilon_1(\alpha), \\ \Pi(\alpha) &= [F_1(\alpha)\bar{v}_1 + F_2(\alpha)\bar{v}_2]^\top [\mathcal{E}(\alpha) - \bar{v}_1 + \bar{v}_3], \\ \mathcal{X}(\alpha) &= \epsilon X^\top(\alpha)v_1 + X^\top(\alpha)v_2 + X^\top(\alpha)v_4, \\ \Upsilon_1(\alpha) &= \widetilde{A}(\alpha)v_2 + A_d(\alpha)v_4 + E\bar{v}_2 + G(\alpha)\tilde{v} - v_1, \\ \widetilde{A}(\alpha) &= A(\alpha) - X(\alpha)^{-1}L(\alpha)C + \omega EE^\top, \\ \mathcal{E}(\alpha) &= -\omega E^\top (E\bar{v}_2 + (A(\alpha) + \omega EE^\top)v_2 + A_d(\alpha)v_4 + G(h)\tilde{v}).\end{aligned} \quad (38)$$

Hence, from (36) and (37), it follows that

$$\dot{V}(t) + 2\beta V(t) \leq \xi^\top(t)(\Xi(\tau) - \mathcal{H}(\alpha) + \text{He}\{\Upsilon(\alpha) + \Pi(\alpha)\})\xi(t). \quad (39)$$

To ensure that system (16) is ISS with respect to $\dot{f}(t)$, it suffices that

$$\dot{V}(t) \leq -2\beta V(t) + \gamma \dot{f}^\top(t)\dot{f}(t). \quad (40)$$

It follows from (39) and (40) that

$$\dot{V}(t) + 2\beta V(t) \leq \xi^\top(t) (\Xi(\tau) - \mathcal{H}(\alpha) + \text{He}\{\Upsilon(\alpha) + \Pi(\alpha)\} + \mathcal{F}) \xi(t), \quad (41)$$

with $\mathcal{F} = \text{diag}(0_{8n_x}, 0_{2n_f}, -\gamma I_{n_f}, 0_{n_\phi})$. Based on the convexity with respect to τ and the Schur complement lemma, it follows that

$$\Theta(\alpha, \tau) = \begin{bmatrix} \Psi(\tau) - \mathcal{H}(\alpha) + \text{He}\{\Upsilon(\alpha) + \Pi(\alpha)\} - e^{-2\beta\bar{\tau}} \mathcal{G}^\top \Phi(\tau) \mathcal{G} & \star \\ [e^{-\beta\bar{\tau}} Y_1^\top & 0] \mathcal{G} & -\tilde{R}_2 \end{bmatrix} \prec 0, \quad (42)$$

with $\tau \in [\underline{\tau}, \bar{\tau}]$ and the matrices $\Psi(\tau)$ and $\Phi(\tau)$ are defined as in (21). The parameter-dependent matrices $X(\alpha)$, $L(\alpha)$, $H(\alpha)$, $F_1(\alpha)$, and $F_2(\alpha)$ are parameterized as

$$\begin{bmatrix} X(\alpha) & L(\alpha) & H(\alpha) & F_1(\alpha) & F_2(\alpha) \end{bmatrix} = \sum_{i=1}^N \alpha_i \begin{bmatrix} X_i & L_i & H_i & F_{1i} & F_{2i} \end{bmatrix}.$$

Hence, the expressions $\Theta(\alpha, \tau)$ in (42) can be rewritten as

$$\Theta(\alpha, \tau) = \sum_{i=1}^N \sum_{j=1}^N \alpha_i \alpha_j \Theta_{ij}(\tau) = \sum_{i=1}^N \alpha_i^2 \Theta_{ii}(\tau) + \sum_{i=1}^N \sum_{j>i}^N \alpha_i \alpha_j \Theta_{ij}(\tau). \quad (43)$$

It is clear from (42) and (43) that condition (41) holds if conditions in (18) are verified. Once the condition (40) is satisfied, by the comparison lemma [32], it follows that

$$V(t) \leq e^{-2\beta(t-t_0)} V(t_0) + \frac{\gamma}{2\beta} [1 - e^{-2\beta(t-t_0)}] \|\dot{f}(t)\|_\infty^2. \quad (44)$$

As $t \rightarrow \infty$, we have

$$V(t) \leq \frac{\gamma}{2\beta} \|\dot{f}(t)\|_\infty^2 \leq \frac{\gamma \delta^2}{2\beta}.$$

Since $\varepsilon_x^\top(t) \bar{P} \varepsilon_x(t) + \varepsilon_\zeta^\top(t) \Gamma \varepsilon_\zeta(t) \leq V(t)$, then the ellipsoid (23) is attractive with respect to system (16). Please notice that the first block of Eq. (19) and Eq. (20) can be expressed as $\underline{\tau}^2 \hat{R}_1 + \tilde{\tau}^2 e^{-2\beta\bar{\tau}} \hat{R}_2 - \epsilon X(\alpha) - \epsilon X(\alpha)^\top \prec 0$. Since R_1 and R_2 are positive definite matrices, one can conclude that $X(\alpha) + X(\alpha)^\top \succ 0$, ensuring the existence of the inverse of matrix $X(\alpha)$. This concludes the proof.

Remark 5. *The volume of the attractive ellipsoid (23) depends on three parameters, i.e., the induced gain γ , the decay rate β , and the assumed bound δ of $\dot{f}(t)$. For any fault signals, to reduce the ultimate bound of the estimation error, the volume of the attractive ellipsoid can be minimized by minimizing the induced gain γ and maximizing the decay rate β . In particular, notice that for time-invariant fault signals, i.e., $\dot{f}(t) = 0$, the attractive ellipsoid tends to the origin, thus ensuring the exponential convergence of the estimation errors to zero. Additionally, the values of β , ϵ , and ω can be determined through a linear grid line-search process. The line-search procedure systematically varies and evaluates different values of β , ϵ , and ω to find the combination that yields the best performance for the induced gain γ .*

3.2. Delay-Free Nonlinear Parameter-Varying Systems

The conditions presented in Theorem 1 can be adapted to deal with delay-free nonlinear parameter-varying systems. To this end, the following error dynamics can be derived considering system (1) with $A_d(\alpha) \equiv 0$:

$$\dot{\varepsilon}(t) = \mathcal{A}(\alpha)\varepsilon(t) + \mathcal{G}(\alpha)g(\alpha, x(t), \varepsilon_x(t)) + \mathcal{B}\dot{f}(t), \quad (45)$$

where the matrices $\mathcal{A}(\alpha)$, $\mathcal{G}(\alpha)$ and \mathcal{B} are as in (16).

Corollary 1. *Given positive scalars ϵ , β and ω , if there exist matrices $P \in \mathbb{S}_+^{n_x}$, $\Gamma \in \mathbb{S}_+^{n_f}$, matrices $X_i \in \mathbb{R}^{n_x \times n_x}$, $L_i \in \mathbb{R}^{n_x \times n_y}$, F_{1i} , $F_{2i} \in \mathbb{R}^{n_f \times n_f}$, and a positive scalar γ , such that following inequalities hold*

$$\begin{cases} \bar{\Theta}_{ii} \prec 0, & i = j \\ \bar{\Theta}_{ij} + \bar{\Theta}_{ji} \prec 0, & i < j \end{cases} \quad (46)$$

for all $i, j \in \mathbb{N}_{\leq N}$, with

$$\begin{aligned} \bar{\Theta}_{ij} &= \mathcal{Q} + \mathcal{X}_j \mathcal{M}_{ij} + \mathcal{M}_{ij}^\top \mathcal{X}_j^\top - \varpi^\top \bar{\mathcal{H}}_j \varpi \\ \mathcal{Q} &= \begin{bmatrix} 0_{n_x \times n_x} & P & 0_{n_x \times n_f} & 0_{n_x \times n_f} & 0_{n_x \times n_f} & 0_{n_x \times n_\phi} \\ P & \beta P & 0_{n_x \times n_f} & 0_{n_x \times n_f} & 0_{n_x \times n_f} & 0_{n_x \times n_\phi} \\ 0_{n_f \times n_x} & 0_{n_f \times n_x} & 0_{n_f \times n_f} & \Gamma & 0_{n_f \times n_f} & 0_{n_f \times n_\phi} \\ 0_{n_f \times n_x} & 0_{n_f \times n_x} & \Gamma & \beta \Gamma & 0_{n_f \times n_f} & n_f \times n_\phi \\ 0_{n_f \times n_x} & 0_{n_f \times n_x} & 0_{n_f \times n_f} & 0_{n_f \times n_f} & -\gamma \mathbf{I}_{n_f} & 0_{n_f \times n_\phi} \\ 0_{n_\phi \times n_x} & 0_{n_\phi \times n_x} & 0_{n_\phi \times n_f} & 0_{n_\phi \times n_f} & 0_{n_\phi \times n_f} & 0_{n_\phi \times n_\phi} \end{bmatrix} \\ \mathcal{X}_j &= \begin{bmatrix} \epsilon \mathbf{I}_{n_x} & 0_{n_x \times n_f} \\ \mathbf{I}_{n_x} & 0_{n_x \times n_f} \\ 0_{n_f \times n_x} & F_{1j} \\ 0_{n_f \times n_x} & F_{2j} \\ 0_{n_f \times n_x} & 0_{n_f \times n_f} \\ 0_{n_\phi \times n_x} & 0_{n_\phi \times n_f} \end{bmatrix} \\ \mathcal{M}_{ij} &= \begin{bmatrix} -X_j & \tilde{A}_{i,j} & 0_{n_x \times n_f} & X_j E & 0_{n_x \times n_f} & X_j G_i \\ 0_{n_f \times n_x} & -\omega E^\top (A_i + \omega E E^\top) & -\mathbf{I}_{n_f} & -\omega E^\top E & \mathbf{I}_{n_f} & -\omega E^\top G_i \end{bmatrix} \\ \varpi &= \begin{bmatrix} 0_{n_x \times n_x} & \mathbf{I}_{n_x} & 0_{n_x \times n_f} & 0_{n_x \times n_f} & 0_{n_x \times n_f} & 0_{n_x \times n_\phi} \\ 0_{n_\phi \times n_x} & 0_{n_\phi \times n_x} & 0_{n_\phi \times n_f} & 0_{n_\phi \times n_f} & 0_{n_\phi \times n_f} & \mathbf{I}_{n_\phi} \end{bmatrix} \\ \bar{\mathcal{H}}_j &= \begin{bmatrix} \mathbf{I}_{n_x} - H_j C & 0_{n_x \times n_\phi} \\ 0_{n_\phi \times n_x} & \mathbf{I}_{n_\phi} \end{bmatrix}^\top \begin{bmatrix} 0_{n_x \times n_x} & -\frac{1}{2} K^\top \\ -\frac{1}{2} K & \mathbf{I}_{n_\phi} \end{bmatrix} \begin{bmatrix} \mathbf{I}_{n_x} - H_j C & 0_{n_x \times n_\phi} \\ 0_{n_\phi \times n_x} & \mathbf{I}_{n_\phi} \end{bmatrix} \end{aligned}$$

and $\tilde{A}_{ij} = X_j A_i - L_j C + \omega X_j E E^\top$. Then, the intermediate observer (6)–(9), with $A_d(\alpha) \equiv 0$, ensures the delay-free system (45) is ISS with respect to $\dot{f}(t)$. Moreover, the ellipsoid

$$\mathcal{R}_\infty = \{ \varepsilon_x \in \mathbb{R}^{n_x}, \varepsilon_\zeta \in \mathbb{R}^{n_f} : \varepsilon_x^\top P \varepsilon_x + \varepsilon_\zeta^\top \Gamma \varepsilon_\zeta \leq \gamma \delta^2 / \beta \}, \quad (47)$$

190 is attractive with respect to system (45).

Proof. For stability analysis, we consider the Lyapunov function

$$\bar{V}(t) = \varepsilon_x^\top(t) P \varepsilon_x(t) + \varepsilon_\zeta^\top(t) \Gamma \varepsilon_\zeta(t). \quad (48)$$

To ensure that the system is ISS with respect to $\dot{f}(t)$, it suffices that

$$\dot{\bar{V}}(t) \leq -\beta \bar{V}(t) + \gamma \dot{f}^\top(t) \dot{f}(t). \quad (49)$$

Note that

$$\dot{\bar{V}}(t) + \beta\bar{V}(t) - \gamma\dot{f}^\top(t)\dot{f}(t) = \bar{\xi}^\top(t)\mathcal{Q}\bar{\xi}(t), \quad (50)$$

with

$$\bar{\xi} = [\dot{\varepsilon}_x^\top(t) \quad \varepsilon_x^\top(t) \quad \dot{\varepsilon}_\zeta^\top(t) \quad \varepsilon_\zeta^\top(t) \quad \dot{f}^\top(t) \quad g^\top(\alpha, x, \varepsilon_x)].$$

It follows from the sector condition defined in (17) that

$$\xi^\top(t)\varpi^\top\overline{\mathcal{H}}(\alpha)\varpi\xi(t) \leq 0, \quad (51)$$

with

$$\overline{\mathcal{H}}(\alpha) = \begin{bmatrix} \mathbf{I}_{n_x} - H(\alpha)C & 0_{n_x \times n_\phi} \\ 0_{n_\phi \times n_x} & \mathbf{I}_{n_\phi} \end{bmatrix}^\top \begin{bmatrix} 0_{n_x \times n_x} & -\frac{1}{2}K^\top \\ -\frac{1}{2}K & \mathbf{I}_{n_\phi} \end{bmatrix} \begin{bmatrix} \mathbf{I}_{n_x} - H(\alpha)C & 0_{n_x \times n_\phi} \\ 0_{n_\phi \times n_x} & \mathbf{I}_{n_\phi} \end{bmatrix}.$$

Therefore, we have from (50) and (51) that

$$\dot{\bar{V}}(t) + \beta\bar{V}(t) - \gamma\dot{f}^\top(t)\dot{f}(t) \leq \bar{\xi}^\top(t)\mathcal{Q}\bar{\xi}(t) - \xi^\top(t)\varpi^\top\overline{\mathcal{H}}(\alpha)\varpi\xi(t). \quad (52)$$

Note also that the following zero-equality holds for any matrices $X(\alpha) \in \mathbb{R}^{n_x \times n_x}$, $F_1(\alpha) \in \mathbb{R}^{n_f \times n_f}$ and $F_2(\alpha) \in \mathbb{R}^{n_f \times n_f}$:

$$\mathcal{X}(\alpha)\mathcal{M}(\alpha)\bar{\xi}(t) = 0, \quad (53)$$

with

$$\mathcal{X}(\alpha) = \begin{bmatrix} \epsilon\mathbf{I}_{n_x} & 0_{n_x \times n_f} \\ \mathbf{I}_{n_x} & 0_{n_x \times n_f} \\ 0_{n_f \times n_x} & F_1(\alpha) \\ 0_{n_f \times n_x} & F_2(\alpha) \\ 0_{n_f \times n_x} & 0_{n_f \times n_f} \\ 0_{n_\phi \times n_x} & 0_{n_\phi \times n_f} \end{bmatrix},$$

$$\mathcal{M}(\alpha) = \begin{bmatrix} -X(\alpha) & \tilde{A}(\alpha) & 0_{n_x \times n_f} & X(\alpha)E & 0_{n_x \times n_f} & X(\alpha)G(\alpha) \\ 0_{n_f \times n_x} & \tilde{E}(\alpha) & -\mathbf{I}_{n_f} & -\omega E^\top E & \mathbf{I}_{n_f} & -\omega E^\top G(\alpha) \end{bmatrix},$$

$$\tilde{A}(\alpha) = X(\alpha)A(\alpha) - L(\alpha)C + \omega X(\alpha)EE^\top,$$

$$\tilde{E}(\alpha) = -\omega E^\top(A(\alpha) + \omega EE^\top).$$

It follows from (52) and (53) that

$$\dot{\bar{V}}(t) + \beta\bar{V}(t) - \gamma\dot{f}^\top(t)\dot{f}(t) \leq \bar{\xi}^\top(t)\bar{\Theta}(\alpha)\bar{\xi}(t) < 0, \quad (54)$$

with

$$\bar{\Theta}(\alpha) = \mathcal{Q} + \mathcal{X}(\alpha)\mathcal{M}(\alpha) + \mathcal{M}^\top(\alpha)\mathcal{X}^\top(\alpha) - \varpi^\top \overline{\mathcal{H}}(\alpha)\varpi. \quad (55)$$

The parameter-dependent matrices $X(\alpha)$, $L(\alpha)$, $H(\alpha)$, $F_1(\alpha)$, and $F_2(\alpha)$ are parameterized as

$$[X(\alpha) \quad L(\alpha) \quad H(\alpha) \quad F_1(\alpha) \quad F_2(\alpha)] = \sum_{i=1}^N \alpha_i [X_i \quad L_i \quad H_i \quad F_{1i} \quad F_{2i}].$$

Hence, the expressions $\bar{\Theta}(\alpha)$ in (55) can be rewritten as

$$\bar{\Theta}(\alpha) = \sum_{i=1}^N \sum_{j=1}^N \alpha_i \alpha_j \bar{\Theta}_{ij} = \sum_{i=1}^N \alpha_i^2 \bar{\Theta}_{ii} + \sum_{i=1}^N \sum_{j>i}^N \alpha_i \alpha_j \bar{\Theta}_{ij}. \quad (56)$$

It is clear from (55) and (56) that conditions in (46) imply (54). By the comparison lemma, this latter, in turn, yields

$$\bar{V}(t) \leq e^{-\beta(t-t_0)} \bar{V}(t_0) + \frac{\gamma}{\beta} [1 - e^{-\beta(t-t_0)}] \|\dot{f}(t)\|_\infty^2. \quad (57)$$

As $t \rightarrow \infty$, we have

$$\bar{V}(t) \leq \frac{\gamma}{\beta} \|\dot{f}(t)\|_\infty^2 \leq \frac{\gamma \delta^2}{\beta}.$$

Since $\varepsilon_x^\top(t)P\varepsilon_x(t) + \varepsilon_\zeta^\top(t)\Gamma\varepsilon_\zeta(t) \leq \bar{V}(t)$, then the ellipsoid (47) is attractive with respect to system (45). This concludes the proof.

4. Numerical Examples

This section presents three numerical examples to illustrate the practical
 195 interests of the proposed design conditions. For the first example, Corol-
 lary 1 is employed to estimate the delay-free dynamics of a satellite launch
 vehicle affected by an actuator fault. For the second and third examples,
 the conditions in Theorem 1 are applied to simultaneously estimate the fault
 and the states of an electronic circuit system and an air-fuel ratio control
 200 system of a spark-ignition (SI) engine, respectively. All the design conditions
 are implemented in MATLAB using the Yalmip parser with the semidefinite
 programming solver MOSEK.

4.1. Example 1: Pitch Dynamics of Satellite Launch Vehicle

Consider the model of a satellite launch vehicle along the pitch axis [6, 34]

$$\begin{aligned}\dot{x}_1(t) &= x_2(t) + 0.1 \sin(x_1(t)) \\ \dot{x}_2(t) &= 2.94u(t) + 2.94f(t) \\ y(t) &= x_1(t)\end{aligned}\tag{58}$$

where x_1 is the pitch angle, x_2 is the pitch rate, and u is the input command along the pitch axis. The fault $f(t)$ can be interpreted as an actuator deflection, modeling uncertainties or disturbances [6]. The nonlinear system (58) can be represented in the form (1) with one vertex, and

$$\begin{aligned}A &= \begin{bmatrix} 0 & 1 \\ 0 & 0 \end{bmatrix}, & A_d &= \begin{bmatrix} 0 & 0 \\ 0 & 0 \end{bmatrix}, & G &= \begin{bmatrix} 0 \\ 0 \end{bmatrix}, \\ E &= \begin{bmatrix} 0 \\ 2.94 \end{bmatrix}, & C &= [1 \ 0], & h(y, u) &= \begin{bmatrix} 0.1 \sin(x_1) \\ 2.94u \end{bmatrix}.\end{aligned}\tag{59}$$

Initially, the aim is to evaluate the influence of the parameter ω and
 205 the decay rate β on the induced gain γ obtained by solving Corollary 1. Considering $\epsilon = 1$ given, Corollary 1 is solved using different values of ω and β and the results are depicted in Figure 1. Clearly, one can notice that there exists a trade-off between the values of β , ω , and γ . Specifically, in this case, higher values of the decay rate β and also ω generally lead to a larger induced
 210 gain γ .

The purpose now is to compare the proposed approach with other techniques present in the literature. As discussed in [6], the observer matching condition is not satisfied, i.e., $\text{rank}(CE) \neq \text{rank}(E)$. Consequently, the adaptive observer proposed in [35] cannot be applied for fault estimation purposes. Hence, Corollary 1 is compared with the intermediate observer design in [6]. Solving the LMI conditions in Corollary 1 with $\epsilon = 1$, $\omega = 0.7$ and $\beta = 1$, we obtain

$$X = \begin{bmatrix} 0.1278 & -0.0017 \\ -0.0113 & 0.0005 \end{bmatrix}, \quad L = \begin{bmatrix} 5.0148 \\ -0.1135 \end{bmatrix},$$

and $\gamma = 1.0674$. In the simulation, three types of fault signals are considered, i.e., constant, ramp, and sinusoidal, which are described in Table 1.

For illustrations, we have considered the initial condition as $x(0) = [0 \ 0]^T$,
 $\hat{x}(0) = [0 \ 0]^T$, and the input control as $u(t) = -0.5963y(t)$. Figure 2 depicts
 215 the simulation result for fault $f(t)$ and its estimate obtained by the proposed

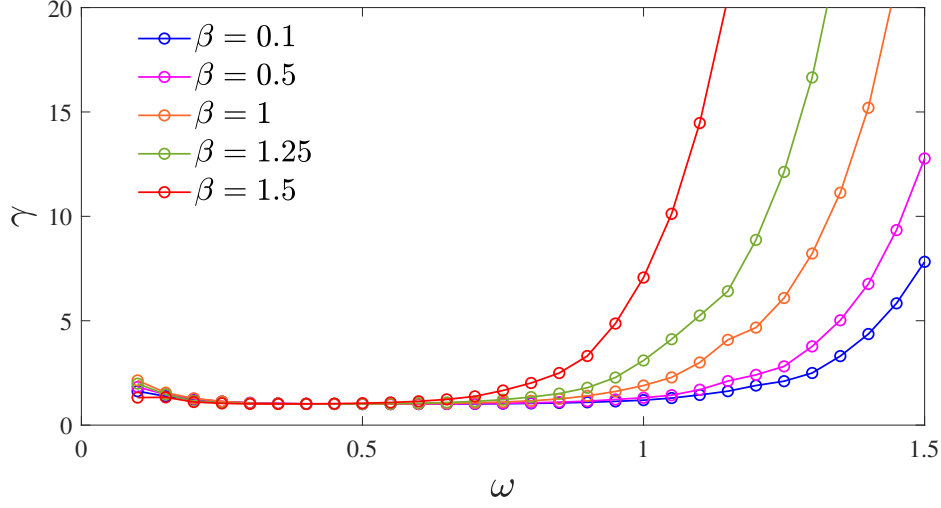

Figure 1: Example 1. Induced gain γ obtained by solving Corollary 1 for different values of ω and β .

Table 1: Description of the fault signal $f(t)$.

t	$[0s, 5s)$	$[5s, 15s)$	$[15s, 25s)$	$[25s, 40s)$	$[40s, 47s)$	$[47s, 70s]$
$f(t)$	0	$0.2t$	0	2	0	$2 \sin(0.2t)$

approach and by the method proposed in [6, Theorem 1]. Figure 3 shows the states and their estimates. The method in [6, Theorem 1] was solved considering $\varepsilon = 1$, $\omega = 0.3$ and $l_g = 0.1$. We can see that the proposed approach presents a better estimation accuracy than the method in [6, Theorem 1].

220 4.2. Example 2: Electronic Circuit System

Consider the electronic circuit system depicted in Figure 4, which can be described for the following dynamical equations [36]:

$$\begin{aligned}
 \dot{x}_1(t) &= -\frac{1}{R_1\bar{C}_1}x_1(t - \tau(t)) + \frac{1}{10R_2\bar{C}_1}x_1(t)x_2(t) - \frac{1}{R_3\bar{C}_1}(u(t) + f(t)) \\
 \dot{x}_2(t) &= -\frac{1}{R_5\bar{C}_2}x_2(t) + \frac{1}{10R_4\bar{C}_2}x_1(t) \\
 \dot{x}_3(t) &= -\frac{1}{R_7\bar{C}_3}x_1(t) - \frac{1}{R_6\bar{C}_3}x_3(t) + \frac{1}{10R_8\bar{C}_3}x_2^2(t) \\
 y(t) &= x_1(t),
 \end{aligned} \tag{60}$$

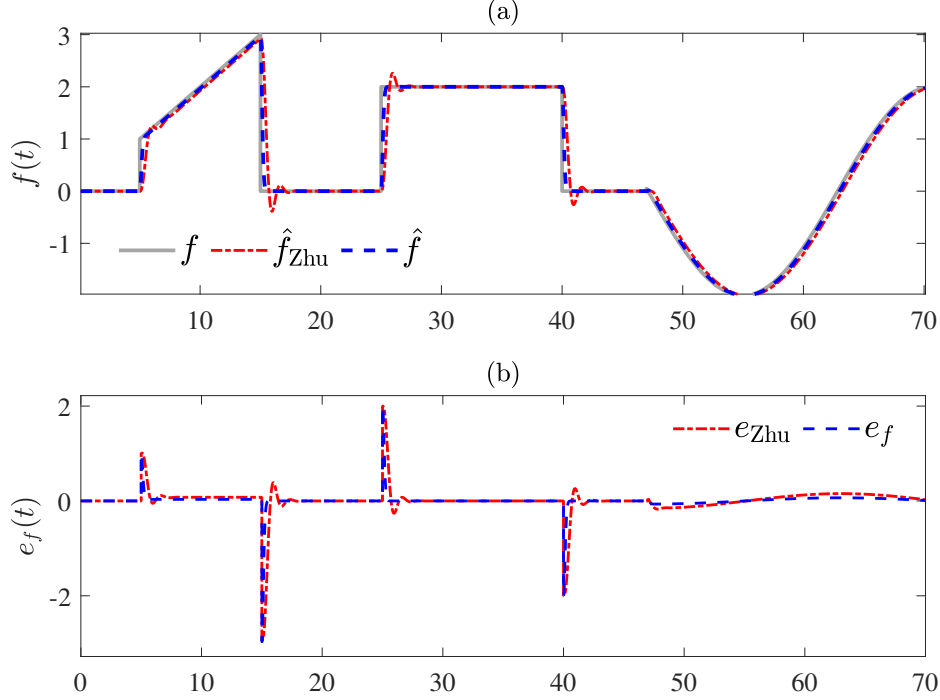

Figure 2: Example 1. (a) Fault $f(t)$ (straight gray line) and its estimation $\hat{f}(t)$ obtained by Corollary 1 (blue dashed line) and $\hat{f}_{\text{Zhu}}(t)$ obtained by [6] (dashed-dotted red line); (b) Fault estimation error $e_f(t)$ obtained by Corollary 1 (blue dashed line) and $e_{\text{Zhu}}(t)$ obtained by [6] (dashed-dotted red line).

where x_j , $j \in \mathbb{N}_{\leq 3}$, are the voltages on the capacitors with $x_1 \in [-2, 2]$, $x_2 \in [-2, 2]$, u is the voltage source, f is the fault signal occurring in the input voltage source. The model parameters are $R_1 = 0.6\text{k}\Omega$, $R_2 = 66.667\Omega$, $R_3 = 0.4\text{k}\Omega$, $R_4 = 16.667\Omega$, $R_5 = 0.2\text{k}\Omega$, $R_6 = 0.5\Omega$, $R_7 = R_8 = 0.1\text{k}\Omega$, $\bar{C}_1 = \bar{C}_3 = 10\text{mF}$ and $\bar{C}_2 = 1\text{mF}$.

Taking $\tilde{\phi}(x) = x_2^2$ as the unmeasured nonlinearity, it is evident that its Jacobian is bounded as

$$\underline{k}_j \leq \frac{\partial \tilde{\phi}(x)}{\partial x_j} \leq \bar{k}_j, \quad \forall j \in \mathbb{N}_{\leq 3},$$

with $\underline{k}_1 = 0$, $\underline{k}_2 = -4$, $\underline{k}_3 = 0$, $\bar{k}_1 = 0$, $\bar{k}_2 = 4$ and $\bar{k}_3 = 0$. Thus, Assumption 3 cannot be directly applied to the nonlinearity $\tilde{\phi}(x) = x_2^2$. However, in accordance with Remark 2, a loop transformation can be employed by defining $\phi(x) = \tilde{\phi}(x) - \underline{K}x$, with $\underline{K} = [0 \ -4 \ 0]$, leading to $\phi(x) = x^2 + 4x_2$.

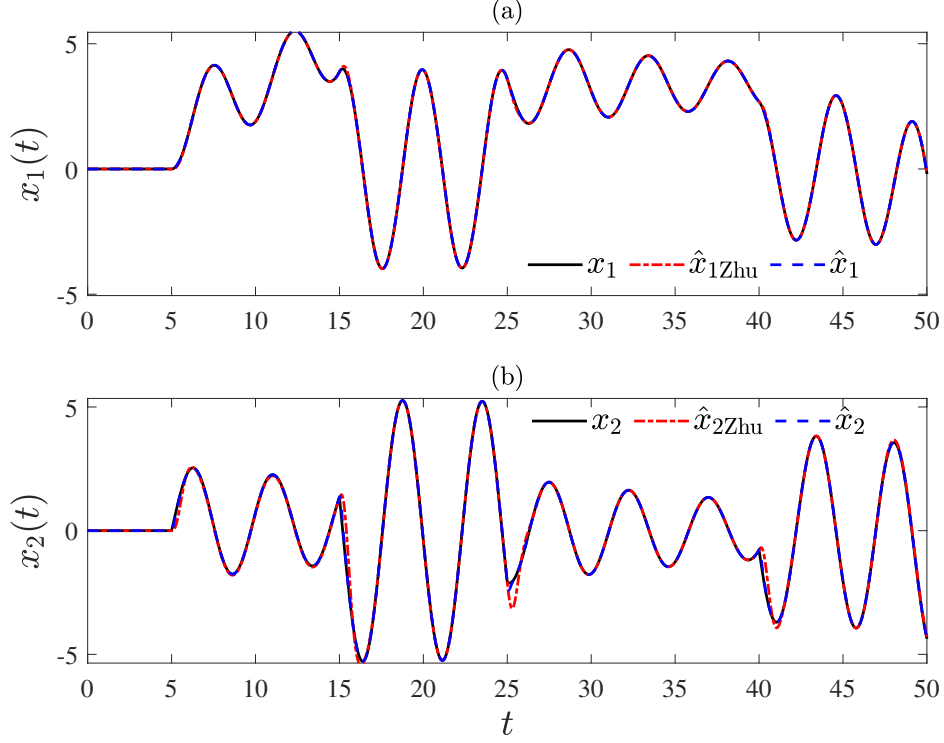

Figure 3: Example 1. System states (straight black line) and their estimates. Comparison between the proposed method and [6, Theorem 1].

Consequently, the boundedness condition of the Jacobian in (3) is satisfied with $k_j = \bar{k}_j - \underline{k}_j$, for $j \in \mathbb{N}_{\leq 3}$, and $K = [0 \ 8 \ 0]$. Therefore, after employing this loop transformation, the system (60) is written as

$$\begin{aligned}
 \dot{x}_1(t) &= -\frac{1}{R_1 \bar{C}_1} x_1(t - \tau(t)) + \frac{1}{10R_2 \bar{C}_1} x_1(t)x_2(t) - \frac{1}{R_3 \bar{C}_1} (u(t) + f(t)) \\
 \dot{x}_2(t) &= -\frac{1}{R_5 \bar{C}_2} x_2(t) + \frac{1}{10R_4 \bar{C}_2} x_1(t) \\
 \dot{x}_3(t) &= -\frac{1}{R_7 \bar{C}_3} x_1(t) - \frac{1}{R_6 \bar{C}_3} x_3(t) - \frac{4}{10R_8 \bar{C}_3} x_2(t) + \frac{1}{10R_8 \bar{C}_3} (x_2^2(t) + 4x_2(t)) \\
 y(t) &= x_1(t)
 \end{aligned} \tag{61}$$

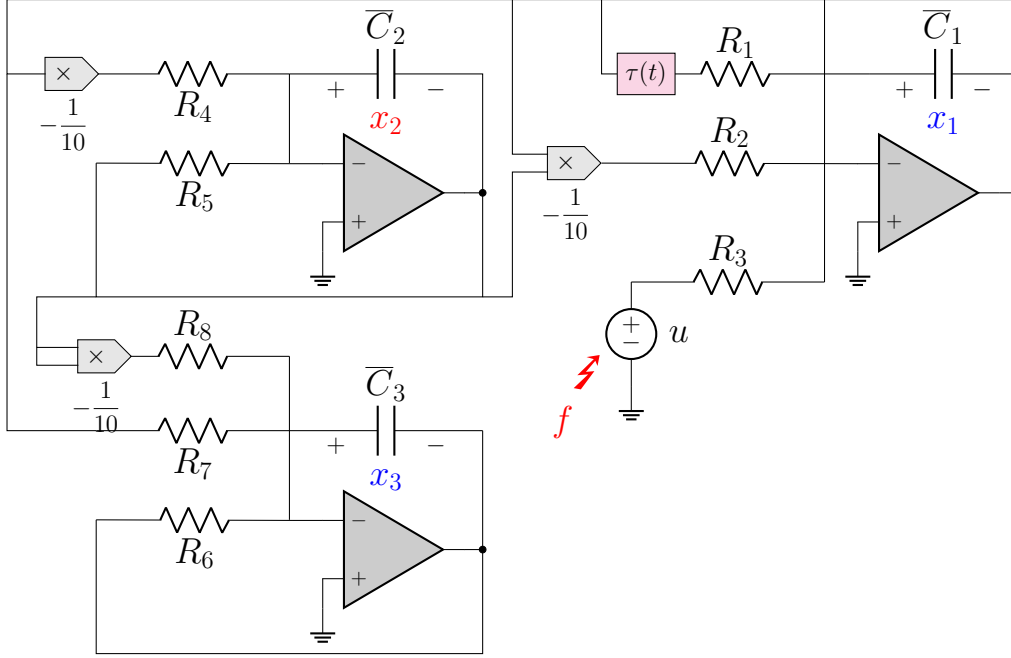

Figure 4: Diagram of the electronic circuit system.

We define the scheduling parameter as $\rho_x = x_1$. Then, the electronic circuit system (61) can be rewritten as in (1) with

$$A(\alpha) = \begin{bmatrix} 0 & \frac{1}{10R_2\bar{C}_1}\rho & 0 \\ \frac{1}{10R_4\bar{C}_2} & \frac{-1}{R_5\bar{C}_2} & 0 \\ \frac{-1}{R_7\bar{C}_3} & \frac{-4}{10R_8\bar{C}_1} & \frac{-1}{R_6\bar{C}_3} \end{bmatrix}, \quad h(y, u) = \begin{bmatrix} \frac{-1}{R_3\bar{C}_1} \\ 0 \\ 0 \end{bmatrix},$$

$$A_d = \begin{bmatrix} \frac{-1}{R_1\bar{C}_1} & 0 & 0 \\ 0 & 0 & 0 \\ 0 & 0 & 0 \end{bmatrix}, \quad E = \begin{bmatrix} \frac{-1}{R_3\bar{C}_1} \\ 0 \\ 0 \end{bmatrix}, \quad G = \begin{bmatrix} 0 \\ 0 \\ \frac{1}{10R_8\bar{C}_1} \end{bmatrix}, \quad C = [1 \ 0 \ 0].$$

Applying the sector nonlinearity approach [24, Chapter 2], system (61) can be represented in the form (1) with 2 vertices, whose state-space matrices

are given by

$$A_1 = \begin{bmatrix} 0 & -0.3 & 0 \\ 6 & -5 & 0 \\ -1 & -0.4 & -0.2 \end{bmatrix}, \quad A_2 = \begin{bmatrix} 0 & 0.3 & 0 \\ 6 & -5 & 0 \\ -1 & -0.4 & -0.2 \end{bmatrix},$$

$$A_d = \begin{bmatrix} -0.1667 & 0 & 0 \\ 0 & 0 & 0 \\ 0 & 0 & 0 \end{bmatrix}, \quad E = \begin{bmatrix} -0.025 \\ 0 \\ 0 \end{bmatrix}, \quad G = \begin{bmatrix} 0 \\ 0 \\ 1 \end{bmatrix}.$$

The corresponding time-varying parameters are given by

$$\alpha_1(\rho_x) = \frac{2 - x_1}{4}, \quad \alpha_2(\rho_x) = 1 - \alpha_1(\rho_x).$$

The nonlinearity x_2^2 cannot be measured, which raises technical difficulties for the fault estimation design. It should be noted that the approaches presented in [19, 20] cannot be applied in this case study because they are not designed to handle unmeasured nonlinearity. For this example, we design a gain-scheduled intermediate observer for system (60) such that the error dynamics is ISS with respect to $\dot{f}(t)$ for a maximum bound of the time-delay. To this end, applying Theorem 1 with $\beta = 0.01$, $\omega = 140$, $\epsilon = 10$, and $\tau = 0$, the maximum delay reached is $\bar{\tau} = 0.52$ s. For this case, the following observer matrices are obtained:

$$X_1 = \begin{bmatrix} 0.0156 & -0.0005 & 0.0000 \\ -0.0048 & 72.3623 & -0.2175 \\ 0.0000 & 0.0676 & 0.1006 \end{bmatrix}, \quad X_2 = \begin{bmatrix} 0.0156 & 0.0005 & 0.0000 \\ 0.0020 & 72.3660 & -0.2174 \\ 0.0000 & 0.0676 & 0.1006 \end{bmatrix},$$

$$L_1 = \begin{bmatrix} 1.7489 \\ 434.3657 \\ 0.3053 \end{bmatrix}, \quad L_2 = \begin{bmatrix} 1.7544 \\ 434.4265 \\ 0.3052 \end{bmatrix}, \quad H_1 = \begin{bmatrix} \bullet \\ -0.0001 \\ \bullet \end{bmatrix}, \quad H_2 = \begin{bmatrix} \bullet \\ 0.0001 \\ \bullet \end{bmatrix},$$

and $\gamma = 0.004$. For comparison purposes, the fault signal given by

$$f(t) = \begin{cases} 0, & 0 \leq t < 5, \\ 0.2t, & 5 \leq t < 10, \\ 0.5 \sin(0.75t), & 10 \leq t < 40, \\ 0.5, & 40 \leq t \leq 50. \end{cases} \quad (62)$$

Notice that according to Assumption 2, by taking the time-derivative of the fault signal, one can compute $\|f\|_\infty \leq \delta$ with $\delta = 0.007$. Figures 5a–5c

depict the system states and their estimates for an initial condition $x(0) = [0.5 \ 0.6 \ 0.75]^\top$ and $\hat{x}(0) = [0 \ 0 \ 0]^\top$. Figure 5d shows the fault signal and its estimation. Figure 5e presents the input control trajectory defined as $u(t) = 2.5 \sin(0.5\pi t) \cos(t)$. Finally, Figure 5f depicts the time-varying delay given by $\tau(t) = 0.26 + 0.26 \cos(t\pi/4)$. We can see that the states of the electronic circuit (60) and the fault signal are accurately estimated despite the effect of the time-varying delay $\tau(t)$.

4.3. Example 3: Air-Fuel Ratio Control System for an SI Engine

This example is concerned with the estimation problem of an air-fuel ratio (AFR) control system, which is composed of three parts: the cylinder mass air flow dynamics, the fuel mass flow dynamics, and the AFR sensor dynamics. Figure 6 shows the schematic diagram of a classical cylinder gasoline engine. The cylinder air flow dynamics can be described by the following speed density equation:

$$\dot{m}_{\text{cyl}}(t) = \frac{(s_1 p_{\text{col}}(t) + s_2) V_d}{120RT_{\text{col}}} N_e(t), \quad (63)$$

where N_e is the engine speed [rpm], p_{col} is the intake manifold pressure [Pa], V_d is the volume displacement [m^3], T_{col} is the manifold temperature [$^\circ\text{K}$], R is the constant for perfect gas [$\text{kJ}/\text{kg}^\circ\text{K}$]. This relation gives an estimate of the cylinder air mass flow through cylinders, where the two constant parameters are given by $s_1 = 0.0281$ and $s_2 = -1.6208$. The AFR in the cylinder λ_{cyl} can be defined as

$$\lambda_{\text{cyl}}(t) = \frac{m_{\text{cyl}}(t)}{\lambda_s m_f(t)}, \quad (64)$$

where λ_s is the air-fuel stoichiometric ratio. Thus, the time derivative of $\lambda_{\text{cyl}}(t)$ is given by

$$\dot{\lambda}_{\text{cyl}}(t) = \frac{1}{\lambda_s} \frac{\dot{m}_{\text{cyl}}(t)}{m_f(t)} - \frac{\dot{m}_f(t)}{m_f(t)} \lambda_{\text{cyl}}(t), \quad (65)$$

where $\dot{m}_f(t)$ is the mass fuel flow into the cylinders [kg/s]. Using the mean value model for a four-cylinder engine, we have [37]

$$\dot{m}_f(t) = \frac{N_e}{30} m_f(t). \quad (66)$$

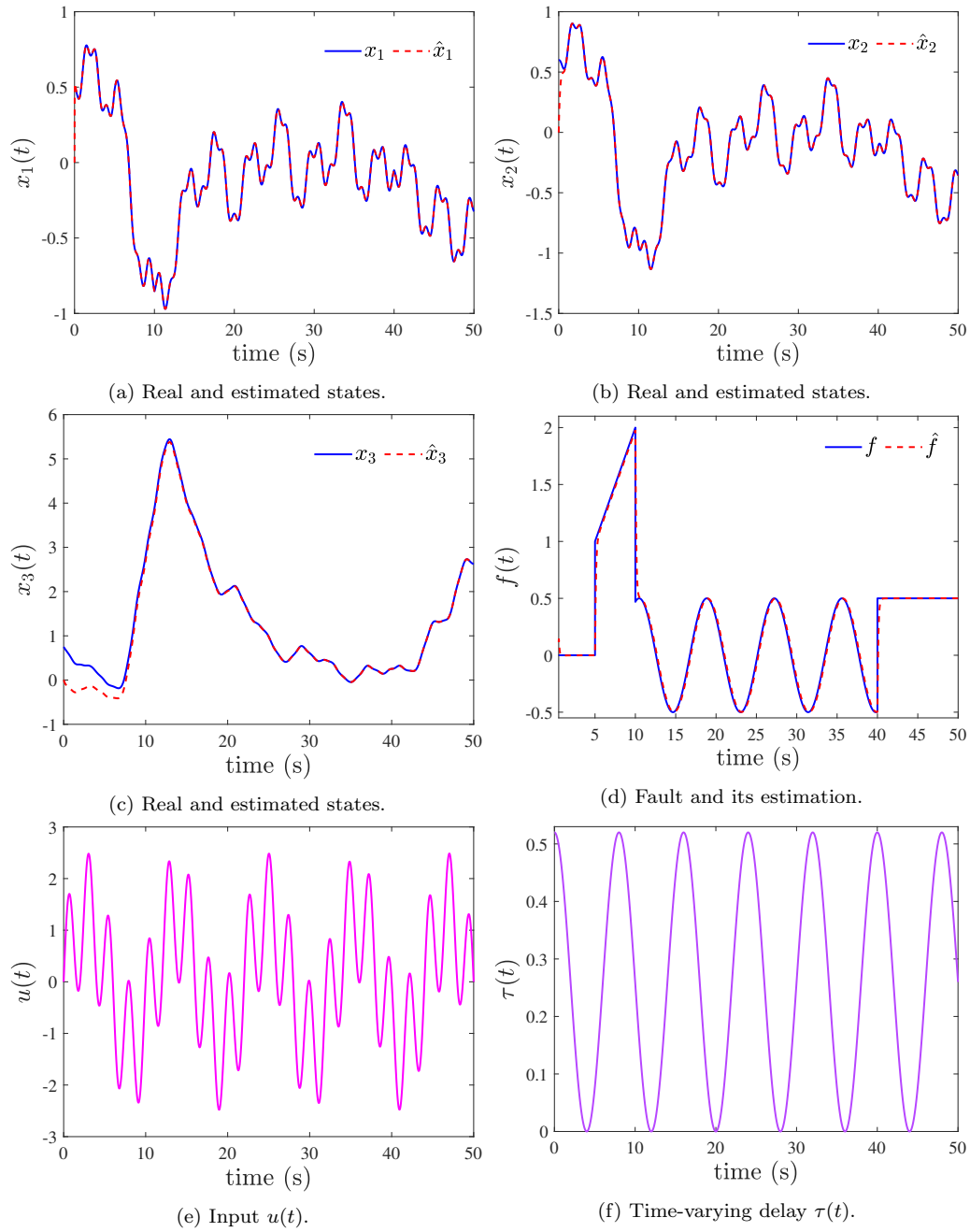

Figure 5: Example 2. Estimation performance obtained for the electronic circuit system (60) under the effect of the fault $f(t)$ and the time-varying delay $\tau(t)$.

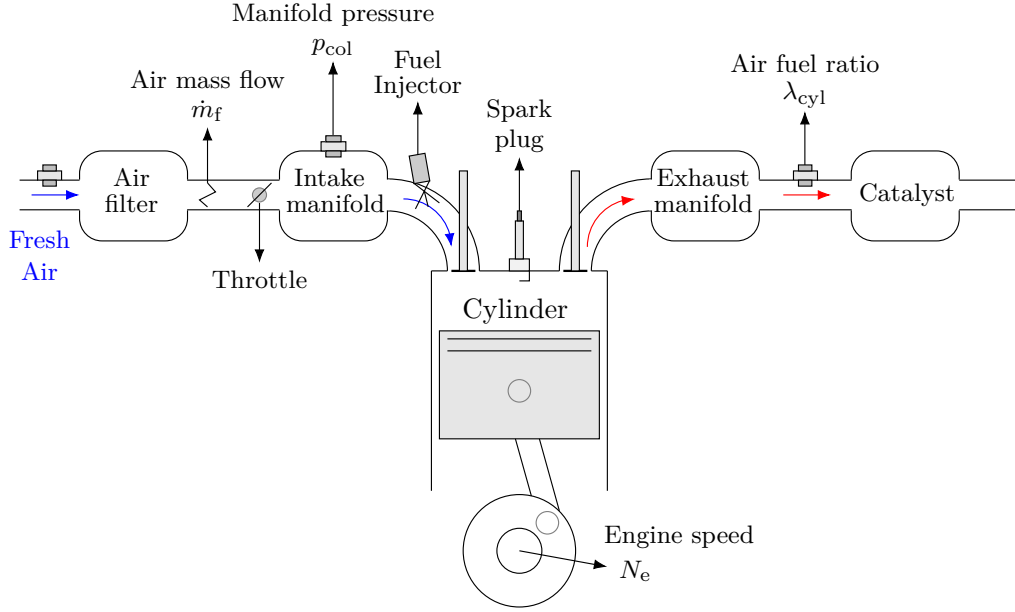

Figure 6: Air-fuel path in a classical gasoline engine.

It follows from (65) and (66) that

$$\dot{\lambda}_{cyl}(t) = \frac{N_e \dot{m}_{cyl}(t)}{30\lambda_s} \frac{1}{\dot{m}_f(t)} - \frac{N_e}{30} \lambda_{cyl}(t). \quad (67)$$

For the AFR control system, a time-varying delay, depending on the engine speed N_e , due to the transport of the gas flow from the cylinder to the lambda sensor is unavoidable [38]. Hence, to measure the AFR, the following lambda sensor dynamics is considered [38, 39]:

$$\dot{\lambda}_{mes}(t) = -\frac{1}{\tau_\lambda} \lambda_{mes}(t) + \frac{1}{\tau_\lambda} \lambda_{cyl}(t - \tau(N_e)) \quad (68)$$

with

$$\tau(N_e) = \frac{86.6}{N_e(t)}. \quad (69)$$

The dynamics of the engine speed N_e can be described as [37]

$$\dot{N}_e(t) = \frac{1}{I_e} (T_{ind}(t) - T_{br}(t) - T_f(t)), \quad (70)$$

where T_{br} is the brake torque, which is assumed to be regulated by the speed controller

$$T_{\text{br}}(t) = 0.1(N_e(t) - r) + 0.01 \int_0^t (N_e(s) - r) ds, \quad (71)$$

where r is the reference signal, T_f represents a lumped fault of the braking system and other torque frictions, I_e is the rotational moment of the engine inertia. The effective indicated torque T_{ind} is modeled as [37]

$$T_{\text{ind}}(t) = \frac{H_u \eta_i \dot{m}_{\text{cyl}}(t)}{\lambda_s N_e(t)} \frac{1}{\lambda_{\text{cyl}}(t)}, \quad (72)$$

where H_u is the fuel energy constant, and η_i is the thermal efficiency multiplier. The AFR dynamics can be then represented from subsystems (67), (68) and (70) as

$$\begin{aligned} \dot{x}_1(t) &= -\frac{x_1(t)x_3(t)}{30} + \frac{\dot{m}_{\text{cyl}}(t)x_3(t)}{30\lambda_s} \frac{1}{\dot{m}_f(t)} \\ \dot{x}_2(t) &= -\frac{1}{\tau_\lambda} x_2(t) + \frac{1}{\tau_\lambda} x_1(t - \tau(t)) \\ \dot{x}_3(t) &= \frac{H_u \eta_i (s_1 p_{\text{col}}(t) + s_2) V_d}{120 \lambda_s R T_{\text{col}} I_e} \frac{1}{x_1(t)} - \frac{T_{\text{br}}(t)}{I_e} - \frac{T_f(t)}{I_e} \end{aligned} \quad (73)$$

where $x_1(t) = \lambda_{\text{cyl}}(t)$, $x_2(t) = \lambda_{\text{mes}}(t)$ and $x_3(t) = N_e(t)$. Table 2 provides the engine parameters. The nonlinear system described in (73) can be reformulated in a nonlinear parameter-varying time-delay system as

$$\begin{aligned} \begin{bmatrix} \dot{x}_1(t) \\ \dot{x}_2(t) \\ \dot{x}_3(t) \end{bmatrix} &= \begin{bmatrix} -\frac{x_3}{30} & 0 & 0 \\ 0 & -\frac{1}{\tau_\lambda} & 0 \\ 0 & 0 & 0 \end{bmatrix} \begin{bmatrix} x_1(t) \\ x_2(t) \\ x_3(t) \end{bmatrix} + \begin{bmatrix} 0 & 0 & 0 \\ \frac{1}{\tau_\lambda} & 0 & 0 \\ 0 & 0 & 0 \end{bmatrix} \begin{bmatrix} x_1(t - \tau(t)) \\ x_2(t - \tau(t)) \\ x_3(t - \tau(t)) \end{bmatrix} \\ &+ \begin{bmatrix} \frac{\dot{m}_{\text{cyl}} x_3}{30 \lambda_s} & 0 \\ 0 & 0 \\ 0 & -\frac{1}{I_e} \end{bmatrix} \begin{bmatrix} \frac{1}{\dot{m}_f} \\ T_{\text{br}} \end{bmatrix} + \begin{bmatrix} 0 \\ 0 \\ \frac{H_u \eta_i (s_1 p_{\text{col}}(t) + s_2) V_d}{120 \lambda_s R T_{\text{col}} I_e} \end{bmatrix} \frac{1}{x_1(t)} + \begin{bmatrix} 0 \\ 0 \\ -\frac{1}{I_e} \end{bmatrix} T_f(t) \\ y(t) &= \begin{bmatrix} 0 & 1 & 0 \\ 0 & 0 & 1 \end{bmatrix} \begin{bmatrix} x_1(t) \\ x_2(t) \\ x_3(t) \end{bmatrix}. \end{aligned} \quad (74)$$

For a standard operating condition of a naturally aspirated SI engine, i.e., without a turbocharger, we have the physical bounds of the engine state variables as $x_1 \in [0.5, 1.5]$, $x_3 \in [1000, 4000]$ and $p_{\text{col}}(t) \in [3 \times 10^4, 2 \times 10^5]$. Hence,

the lower and upper bounds of the time-varying delay can be derived from
 240 (69) as $\underline{\tau} = 0.02$ and $\bar{\tau} = 0.1$. For system (74), $\rho_1(t) = x_3$ and $\rho_2(t) = p_{\text{col}}(t)$
 are selected as scheduling functions. Considering the unmeasured nonlinear-
 earity $\tilde{\phi}(x) = \frac{1}{x_1}$, Assumption 3 cannot be directly applied. However, by
 employing the loop-transformation as described in Remark 2, such that
 $\phi(x) = \tilde{\phi}(x) - \underline{K}x$, where $\underline{K} = [-0.44 \ 0 \ 0]$, we obtain $\phi(x) = \frac{1}{x_1} + 4x_1$
 245 that satisfies the sector condition (3) with $K = [3.56 \ 0 \ 0]$.

Table 2: Parameter values of the AFR engine model.

Description	Parameters	Values	Units
volume displacement	V_d	0.6×10^{-3}	m^3
manifold temperature	T_{col}	293	$^{\circ}\text{K}$
constant for perfect gas	R	0.287	$\text{kJ}/\text{kg}^{\circ}\text{K}$
air-fuel stoichiometric ratio	λ_s	14.67	-
fuel energy constant	H_u	18×10^5	Nm/Kg
thermal efficiency multiplier	η_i	0.7	-
rotational moment of Inertia	I_e	0.1307	kgm^2
time constant	τ_λ	0.1	s

Applying the sector nonlinearity approach [40], the engine model (74) can
 be represented as an N-LPV system in (1) with four vertices

$$\begin{aligned}
 A_1 &= \begin{bmatrix} -\frac{100}{3} & 0 & 0 \\ 0 & -10 & 0 \\ -131.5034 & 0 & 0 \end{bmatrix}, \quad A_2 = \begin{bmatrix} -\frac{100}{3} & 0 & 0 \\ 0 & -10 & 0 \\ -878.1251 & 0 & 0 \end{bmatrix}, \\
 A_3 &= \begin{bmatrix} -\frac{400}{3} & 0 & 0 \\ 0 & -10 & 0 \\ -131.5034 & 0 & 0 \end{bmatrix}, \quad A_4 = \begin{bmatrix} -\frac{400}{3} & 0 & 0 \\ 0 & -10 & 0 \\ -878.1251 & 0 & 0 \end{bmatrix}, \\
 G_1 = G_3 &= \begin{bmatrix} 0 \\ 0 \\ 32.8759 \end{bmatrix}, \quad G_2 = G_4 = \begin{bmatrix} 0 \\ 0 \\ 219.5313 \end{bmatrix}, \\
 A_d &= \begin{bmatrix} 0 & 0 & 0 \\ 10 & 0 & 0 \\ 0 & 0 & 0 \end{bmatrix}, \quad E = \begin{bmatrix} 0 \\ 0 \\ -7.6511 \end{bmatrix}.
 \end{aligned} \tag{75}$$

Solving the conditions in Theorem 1 with $\epsilon = 0.5$, $\beta = 0.1$ and $\omega = 0.35$,
 a gain-scheduled intermediate observer is obtained, whose vertices are de-

scribed by

$$\begin{aligned}
L_1 &= \begin{bmatrix} 99.9901 & 0.0099 \\ 1931.4 & 0.2984 \\ 0.3252 & 0.0040 \end{bmatrix}, \quad L_2 = \begin{bmatrix} 98.7995 & 0.0074 \\ 1935.90 & 0.33704 \\ 0.32397 & 0.0038 \end{bmatrix}, \\
L_3 &= \begin{bmatrix} 266.91 & 0.02496 \\ 1993.3 & 0.3229 \\ 0.2913 & 0.0040 \end{bmatrix}, \quad L_4 = \begin{bmatrix} 270.7 & 0.0349 \\ 1999.10 & 0.3190 \\ 0.2777 & 0.0038 \end{bmatrix}, \\
X_1 &= \begin{bmatrix} 14.30528 & 2.91231 & 0.00016 \\ 2.95964 & 7.64046 & -0.00007 \\ -0.00003 & 0.00103 & 0.00003 \end{bmatrix}, \quad X_2 = \begin{bmatrix} 14.30721 & 2.89729 & 0.00093 \\ 2.95831 & 7.48720 & 0.00060 \\ -0.00022 & 0.00234 & 0.00002 \end{bmatrix}, \\
X_3 &= \begin{bmatrix} 5.63206 & 4.58469 & -0.00089 \\ 0.68650 & 7.43109 & -0.00029 \\ 0.00011 & 0.00131 & 0.00003 \end{bmatrix}, \quad X_4 = \begin{bmatrix} 5.67055 & 4.40367 & -0.00134 \\ 0.76165 & 6.73330 & -0.00051 \\ -0.00011 & 0.00197 & 0.00002 \end{bmatrix}, \\
H_1 &= \begin{bmatrix} -5.9195 & 0.0049 \\ \bullet & \bullet \\ \bullet & \bullet \end{bmatrix}, \quad H_2 = \begin{bmatrix} -3.6536 & 0.0303 \\ \bullet & \bullet \\ \bullet & \bullet \end{bmatrix}, \\
H_3 &= \begin{bmatrix} -2.0551 & 0.0012 \\ \bullet & \bullet \\ \bullet & \bullet \end{bmatrix}, \quad H_4 = \begin{bmatrix} 0.9156 & 0.0327 \\ \bullet & \bullet \\ \bullet & \bullet \end{bmatrix},
\end{aligned} \tag{76}$$

and $\gamma = 5.4862 \times 10^{-6}$. For simulations, the fault signal is given by

$$T_f(t) = \begin{cases} 10 \sin(0.5\pi t), & 0 \leq t < 5, \\ -5, & 5 \leq t < 10, \\ 15 \sin(\pi t), & 10 \leq t \leq 20. \end{cases} \tag{77}$$

The initial conditions are $x(0) = [0.55 \ 0.6 \ 2400]^\top$ and $\hat{x}(0) = [0.5 \ 0.7 \ 2200]^\top$. The time-varying delay is computed as in (69). Figure 7 depicts the intake manifold pressure $p_{\text{col}}(t)$, the input signal $u(t)$, the reference signal $r(t)$, and the corresponding break torque $T_{\text{br}}(t)$ given by (71).

250 Figures 8a–8c show the system states and their corresponding estimates. Figure 8d presents the simulation result for the fault estimation obtained with the proposed approach. This result illustrates the practical interest of the proposed fault estimation design for N-LPV systems with time-varying delays and unmeasured nonlinearities.

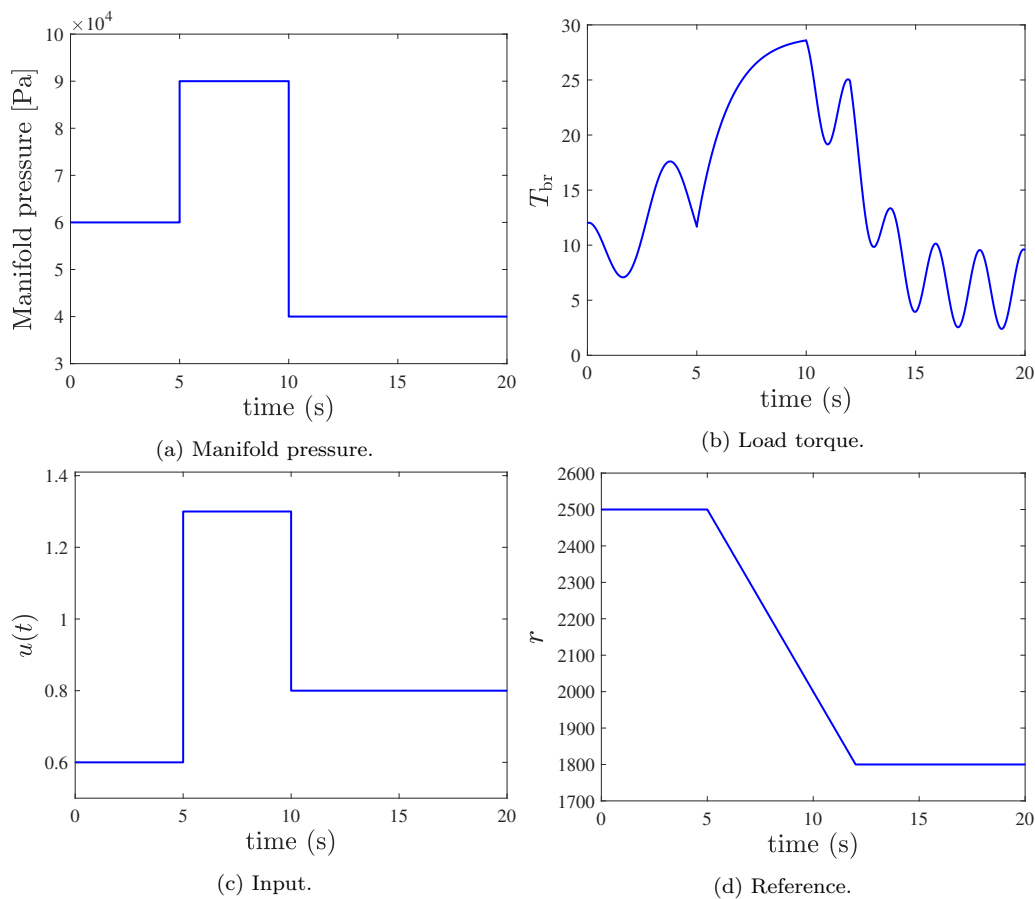

Figure 7: Example 3. Trajectories of the manifold pressure (p_{col}), the load torque (T_{br}), the input (u) and the input reference (r).

255 **5. Conclusions**

This paper has addressed the problem of simultaneous estimation of states and faults affecting nonlinear parameter-varying systems with time-varying delays. Design conditions have been proposed to design a gain-scheduling intermediate estimator to ensure that the error dynamics are ISS with respect to the time derivative of the fault. As a sub-product, a condition has been derived to design a gain-scheduling intermediate estimator for a nonlinear parameter-varying system without time-varying delays. Three numerical examples with physically motivated systems subject to faults have been considered to illustrate the application of the proposal. The results indicate the

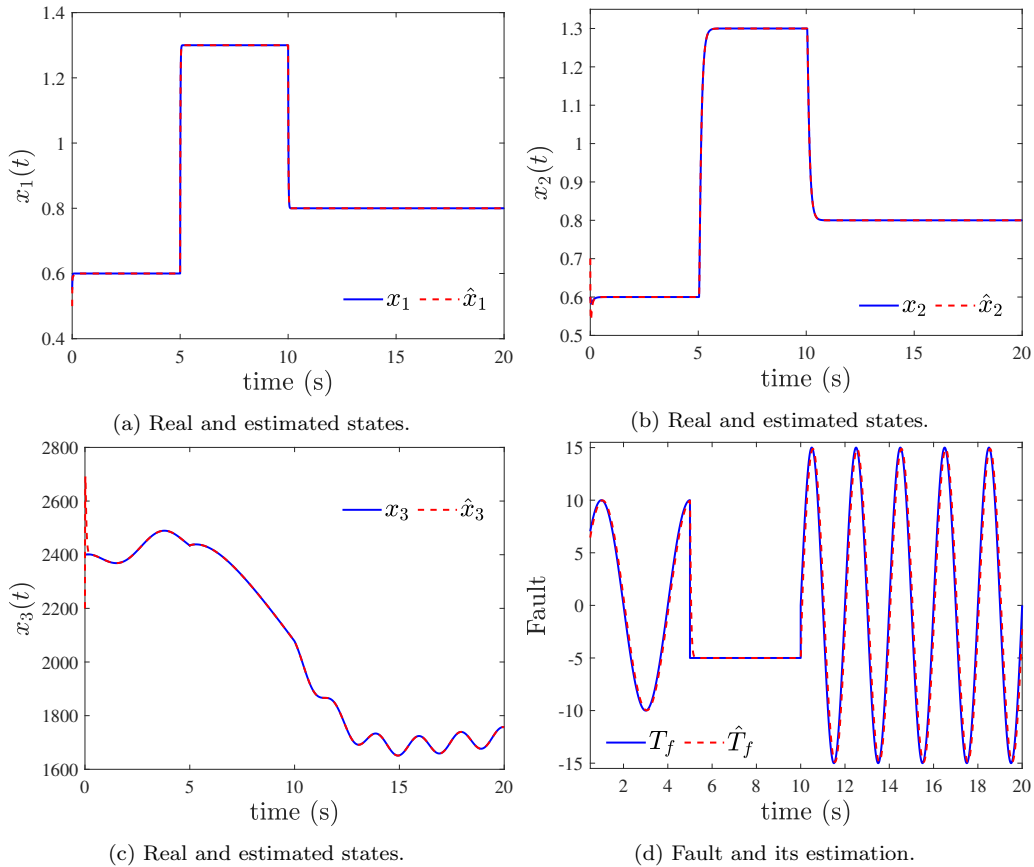

Figure 8: Example 3. Estimation performance obtained for the AFR engine model (73) under the effect of the fault T_f .

265 effectiveness of the designed gain-scheduling intermediate estimator in providing simultaneous state and fault estimations affecting the systems. For future works, we extend the results for nonlinear parameter-varying systems with sampled outputs.

Acknowledgements

270 This work was supported by the Brazilian agency CNPq (Grant numbers: 305578/2022-7, 150602/2022-7, 164692/2020-7).

Appendix A. Instrumental Lemmas

The following lemmas are used to develop the proposed results.

Lemma 2 (Wirtinger-based integral inequality [41]). For any symmetric positive definite matrix $R \in \mathbb{R}^{n \times n}$, the following inequality holds for all continuously differentiable function $\omega \in [a, b] \rightarrow \mathbb{R}^n$:

$$(b-a) \int_a^b \dot{\omega}^\top(s) R \dot{\omega}(s) ds \geq \begin{bmatrix} \Theta_1 \\ \Theta_2 \end{bmatrix}^\top \begin{bmatrix} R & 0 \\ 0 & 3R \end{bmatrix} \begin{bmatrix} \Theta_1 \\ \Theta_2 \end{bmatrix}$$

where $\Theta_1 = \omega(b) - \omega(a)$ and $\Theta_2 = \omega(b) + \omega(a) - \frac{2}{b-a} \int_a^b \omega(s) ds$.

Lemma 3 (Delay-dependent reciprocally convex inequality [42]). Let $R_1, R_2 \in \mathbb{R}^{n \times n}$ be symmetric positive definite matrices. If there exist symmetric matrices $X_1, X_2 \in \mathbb{R}^{n \times n}$ and matrices $Y_1, Y_2 \in \mathbb{R}^{n \times n}$ such that

$$\begin{bmatrix} R_1 & 0 \\ 0 & R_2 \end{bmatrix} - \varrho \begin{bmatrix} X_1 & Y_1 \\ Y_1^\top & 0 \end{bmatrix} - (1-\varrho) \begin{bmatrix} 0 & Y_2 \\ Y_2^\top & X_2 \end{bmatrix} \geq 0$$

holds for $\varrho \in \mathbb{B}$. Then, the following inequality

$$\begin{bmatrix} \frac{1}{\varrho} R_1 & 0 \\ 0 & \frac{1}{1-\varrho} R_2 \end{bmatrix} \geq \begin{bmatrix} R_1 & 0 \\ 0 & R_2 \end{bmatrix} + (1-\varrho) \begin{bmatrix} X_1 & Y_2 \\ Y_2^\top & 0 \end{bmatrix} + \varrho \begin{bmatrix} 0 & Y_1 \\ Y_1^\top & X_2 \end{bmatrix} \quad (\text{A.1})$$

275 holds for all $\varrho \in (0, 1) \subset \mathbb{R}$.

References

- [1] D. Du, B. Jiang, Actuator fault estimation and accommodation for switched systems with time delay: Discrete-time case, ISA transactions 62 (2016) 137–144.
- 280 [2] J. Lan, R. J. Patton, A new strategy for integration of fault estimation within fault-tolerant control, Automatica 69 (2016) 48–59.
- [3] I. Bessa, V. Puig, R. M. Palhares, TS fuzzy reconfiguration blocks for fault tolerant control of nonlinear systems, Journal of the Franklin Institute 357 (8) (2020) 4592–4623.
- 285 [4] I. Bessa, V. Puig, R. M. Palhares, Passivation blocks for fault tolerant control of nonlinear systems, Automatica 125 (2021) 109450.

- 290 [5] B. Zhu, Y. Wang, H. Zhang, X. Xie, Distributed finite-time fault estimation and fault-tolerant control for cyber-physical systems with matched uncertainties, *Applied Mathematics and Computation* 403 (2021) 126195.
- [6] J.-W. Zhu, G. Yang, H. Wang, F. Wang, Fault Estimation for a Class of Nonlinear Systems Based on Intermediate Estimator, *IEEE Transactions on Automatic Control* 61 (9) (2016) 2518–2524.
- 295 [7] C. Edwards, S. K. Spurgeon, R. J. Patton, Sliding mode observers for fault detection and isolation, *Automatica* 36 (4) (2000) 541–553.
- [8] M. Liu, L. Zhang, P. Shi, Y. Zhao, Fault estimation sliding-mode observer with digital communication constraints, *IEEE Transactions on Automatic Control* 63 (10) (2018) 3434–3441.
- 300 [9] B. Jiang, M. Staroswiecki, V. Cocquempot, Fault accommodation for nonlinear dynamic systems, *IEEE Transactions on automatic Control* 51 (9) (2006) 1578–1583.
- [10] J.-J. Yan, G.-H. Yang, Adaptive fault estimation for cyber-physical systems with intermittent dos attacks, *Information Sciences* 547 (2021) 746–762.
- 305 [11] C. M. García, V. Puig, C. Astorga-Zaragoza, G. Osorio-Gordillo, Robust fault estimation based on interval Takagi-Sugeno unknown input observer, *IFAC-PapersOnLine* 51 (24) (2018) 508–514.
- 310 [12] D. Du, V. Cocquempot, B. Jiang, Robust fault estimation observer design for switched systems with unknown input, *Applied Mathematics and Computation* 348 (2019) 70–83.
- [13] G. Wang, C. Yi, Fault estimation for nonlinear systems by an intermediate estimator with stochastic failure, *Nonlinear Dynamics* 89 (2) (2017) 1195–1204.
- 315 [14] J.-W. Zhu, G.-H. Yang, Fault-tolerant control for linear systems with multiple faults and disturbances based on augmented intermediate estimator, *IET Control Theory & Applications* 11 (2) (2017) 164–172.

- 320 [15] J.-W. Zhu, G.-H. Yang, W.-A. Zhang, L. Yu, Cooperative fault tolerant tracking control for multiagent systems: An intermediate estimator-based approach, *IEEE transactions on cybernetics* 48 (10) (2017) 2972–2980.
- [16] J.-W. Zhu, Q. Wang, S. X. Ding, W.-A. Zhang, L. Yu, Performance guaranteed attack reconstruction for cyber–physical systems: A new intermediate estimator-based framework, *Automatica* 142 (2022) 110388.
- 325 [17] X.-G. Yan, S. K. Spurgeon, C. Edwards, State and parameter estimation for nonlinear delay systems using sliding mode techniques, *IEEE Transactions on Automatic Control* 58 (4) (2012) 1023–1029.
- [18] H. Yang, S. Yin, Actuator and sensor fault estimation for time-delay markov jump systems with application to wheeled mobile manipulators, *IEEE Transactions on Industrial Informatics* 16 (5) (2019) 3222–3232.
- 330 [19] H. Hamdi, M. Rodrigues, C. Mechmeche, N. B. Braiek, Observer-based fault diagnosis for time-delay LPV descriptor systems, *IFAC-PapersOnLine* 51 (24) (2018) 1179–1184.
- [20] F. You, S. Cheng, X. Zhang, N. Chen, Robust fault estimation for Takagi-Sugeno fuzzy systems with state time-varying delay, *International Journal of Adaptive Control and Signal Processing* 34 (2) (2020) 141–150.
- 335 [21] J. W. Zhu, G. H. Yang, Fault accommodation for linear systems with time-varying delay, *International Journal of Systems Science* 48 (2) (2017) 316–323.
- 340 [22] Y. Wang, Y. Zhu, W. Ji, Y. Jiang, S. Wang, Fault estimation for continuous-time non-linear switched systems with time-varying delay based on intermediate estimator, *IET Control Theory & Applications* 14 (19) (2020) 3020–3028.
- 345 [23] Y. Wei, D. Tong, Q. Chen, Y. Sun, W. Zhou, Simultaneous actuator and sensor fault estimation for neutral-type systems via intermediate observer, *Transactions of the Institute of Measurement and Control* 44 (7) (2022) 1505–1517.

- [24] K. Tanaka, H. Wang, Fuzzy Control Systems Design and Analysis: a Linear Matrix Inequality Approach, John Wiley & Sons, 2004.
- 350 [25] P. H. Coutinho, I. Bessa, W.-B. Xie, A.-T. Nguyen, R. M. Palhares, A sufficient condition to design unknown input observers for nonlinear systems with arbitrary relative degree, International Journal of Robust and Nonlinear Control 32 (2022) 8331–8348.
- [26] P. H. S. Coutinho, R. F. Araujo, A.-T. Nguyen, R. M. Palhares, A multiple-parameterization approach for local stabilization of constrained Takagi-Sugeno fuzzy systems with nonlinear consequents, Information Sciences 506 (2020) 295–307.
- 360 [27] J. Pan, A.-T. Nguyen, T.-M. Guerra, D. Ichalal, A unified framework for asymptotic observer design of fuzzy systems with unmeasurable premise variables, IEEE Trans. Fuzzy Syst. 29 (10) (2021) 2938–2948.
- [28] A.-T. Nguyen, J. Pan, T.-M. Guerra, Z. Wang, Avoiding Unmeasured Premise Variables in Designing Unknown Input Observers for Takagi-Sugeno Fuzzy Systems, IEEE Control Systems Letters 5 (1) (2021) 79–84.
- 365 [29] M. L. C. Peixoto, A.-T. Nguyen, T.-M. Guerra, R. M. Palhares, Unknown input observers for time-varying delay Takagi-Sugeno fuzzy systems with unmeasured nonlinear consequents, European Journal of Control (2023) 100830.
- [30] E. Fridman, Introduction to Time-Delay Systems, Systems & Control: Foundations & Applications, Springer International Publishing, Cham, 2014.
- 370 [31] D.-J. Lee, Y. Park, Y.-s. Park, Robust \mathcal{H}_∞ sliding mode descriptor observer for fault and output disturbance estimation of uncertain systems, IEEE Transactions on Automatic Control 57 (11) (2012) 2928–2934.
- 375 [32] H. Khalil, Nonlinear Systems, 3rd Edition, Prentice Hall, 2002.
- [33] Y. Wang, R. Rajamani, D. M. Bevly, Observer design for parameter varying differentiable nonlinear systems, with application to slip angle estimation, IEEE Transactions on Automatic Control 62 (4) (2017) 1940–1945.

- 380 [34] R. Das, S. Sen, S. Dasgupta, Robust and fault tolerant controller for attitude control of a satellite launch vehicle, *IET Control Theory & Applications* 1 (1) (2007) 304–312.
- [35] B. Jiang, M. Staroswiecki, V. Cocquempot, Fault accommodation for nonlinear dynamic systems, *IEEE Transactions on Automatic Control* 51 (9) (2006) 1578–1583.
- 385 [36] X. Yang, T. Li, Y. Wu, Y. Wang, Y. Long, Fault estimation and fault tolerant control for discrete-time nonlinear systems with perturbation by a mixed design scheme, *J. Franklin Inst.* 358 (3) (2021) 1860–1887.
- [37] R. Rajamani, *Vehicle Dynamics and Control*, Springer US, 2012.
- 390 [38] J. Lauber, T. M. Guerra, M. Dambrine, Air-fuel ratio control in a gasoline engine, *International Journal of Systems Science* 42 (2) (2011) 277–286.
- [39] Y.-W. Kim, G. Rizzoni, V. I. Utkin, Developing a fault tolerant powertrain control system by integrating design of control and diagnostics, *International Journal of Robust and Nonlinear Control* 11 (11) (2001) 1095–1114.
- 395 [40] K. Tanaka, H. Wang, *Fuzzy Control Systems Design and Analysis: A Linear Matrix Inequality Approach*, John Wiley & Sons, New York, NY, 2001.
- 400 [41] A. Seuret, F. Gouaisbaut, Wirtinger-based integral inequality: Application to time-delay systems, *Automatica* 49 (9) (2013) 2860–2866.
- [42] A. Seuret, F. Gouaisbaut, Stability of Linear Systems With Time-Varying Delays Using Bessel–Legendre Inequalities, *IEEE Transactions on Automatic Control* 63 (1) (2018) 225–232.